



Designed for Fan and Pump Applications

FRENIC-Eco

CAUTION

Thank you for purchasing our FRENIC-Eco series of inverters.

- This product is designed to drive a three-phase induction motor. Read through this instruction manual to be familiar with the handling procedure for correct use.
- Improper handling might result in incorrect operation, a short life, or even a failure of this product as well as the motor.
- Deliver this manual to the end user of this product. Keep this manual in a safe place until this product is discarded.
- For how to use an optional device, refer to the installation and instruction manuals for that optional device.

Copyright © 2005-2010 Fuji Electric Systems Co., Ltd.

All rights reserved.

No part of this publication may be reproduced or copied without prior written permission from Fuji Electric Systems Co., Ltd.

All products and company names mentioned in this manual are trademarks or registered trademarks of their respective holders.

The information contained herein is subject to change without prior notice for improvement.

Preface

Thank you for purchasing our FRENIC-Eco series of inverters.

This product is designed to drive a three-phase induction motor for fan and pump applications. Read through this instruction manual and be familiar with proper handling and operation of this product.

Improper handling might result in incorrect operation, a short life, or even a failure of this product as well as the motor.

Have this manual delivered to the end user of this product. Keep this manual in a safe place until this product is discarded.

Listed below are the other materials related to the use of the FRENIC-Eco. Read them in conjunction with this manual as necessary.



- FRENIC-Eco User's Manual (MEH456)
- RS485 Communication User's Manual (MEH448)
- Catalog (MEH442)
- RS485 Communications Card "OPC-F1-RS" Installation Manual (INR-SI47-0872)
- Relay Output Card "OPC-F1-RY" Instruction Manual (INR-SI47-0873)
- Mounting Adapter for External Cooling "PB-F1" Installation Manual (INR-SI47-0880)
- Panel-mount Adapter "MA-F1" Installation Manual (INR-SI47-0881)
- Multi-function Keypad "TP-G1" Instruction Manual (INR-SI47-0890-E)
- FRENIC Loader Instruction Manual (INR-SI47-0903-E)

The materials are subject to change without notice. Be sure to obtain the latest editions for use.

■ Safety precautions

Read this manual thoroughly before proceeding with installation, connections (wiring), operation, or maintenance and inspection. Ensure you have sound knowledge of the device and familiarize yourself with all safety information and precautions before proceeding to operate the inverter.

Safety precautions are classified into the following two categories in this manual.

 WARNING	Failure to heed the information indicated by this symbol may lead to dangerous conditions, possibly resulting in death or serious bodily injuries.
 CAUTION	Failure to heed the information indicated by this symbol may lead to dangerous conditions, possibly resulting in minor or light bodily injuries and/or substantial property damage.

Failure to heed the information contained under the CAUTION title can also result in serious consequences. These safety precautions are of utmost importance and must be observed at all times.

Application

WARNING

- FRENIC-Eco is designed to drive a three-phase induction motor. Do not use it for single-phase motors or for other purposes.
Fire or an accident could occur.
- FRENIC-Eco may not be used for a life-support system or other purposes directly related to the human safety.
- Though FRENIC-Eco is manufactured under strict quality control, install safety devices for applications where serious accidents or material losses are foreseen in relation to the failure of it.
An accident could occur.

Installation

WARNING

- Install the inverter on a nonflammable material such as metal.
Otherwise fire could occur.
- Do not place flammable matter nearby.
Doing so could cause fire.

CAUTION

- Do not support the inverter by its terminal block cover during transportation.
Doing so could cause a drop of the inverter and injuries.
- Prevent lint, paper fibers, sawdust, dust, metallic chips, or other foreign materials from getting into the inverter or from accumulating on the heat sink.
Otherwise, a fire or an accident might result.
- Do not install or operate an inverter that is damaged or lacking parts.
Doing so could cause fire, an accident or injuries.
- Do not get on a shipping box.
- Do not stack shipping boxes higher than the indicated information printed on those boxes.
Doing so could cause injuries.

Wiring

WARNING

- When wiring the inverter to the power source, insert a recommended molded case circuit breaker (MCCB) or residual-current-operated protective device (RCD)/earth leakage circuit breaker (ELCB) (with overcurrent protection) in the path of power lines. Use the devices within the recommended current range.
- Use wires in the specified size.
Otherwise, fire could occur.
- Do not use one multicore cable in order to connect several inverters with motors.
- Do not connect a surge killer to the inverter's output (secondary) circuit.
Doing so could cause fire.
- Ground the inverter in compliance with the national or local electric code.
Otherwise, electric shock could occur.
- Qualified electricians should carry out wiring.
- Be sure to perform wiring after turning the power OFF.
Otherwise, electric shock could occur.
- Be sure to perform wiring after installing the inverter body.
Otherwise, electric shock or injuries could occur.
- Ensure that the number of input phases and the rated voltage of the product match the number of phases and the voltage of the AC power supply to which the product is to be connected.
Otherwise fire or an accident could occur.
- Do not connect the power source wires to output terminals (U, V, and W).
Doing so could cause fire or an accident.
- Generally, control signal wires are not enforced- insulated. If they accidentally touch any of live parts in the main circuit, their insulation coat may break for any reasons. In such a case, an extremely high voltage may be applied to the signal lines. Make a complete remedy to protect the signal line from contacting any hot high voltage lines.
Otherwise, an accident or electric shock could occur.

CAUTION

- Wire the three-phase motor to terminals U, V, and W of the inverter, aligning phases each other.
Otherwise injuries could occur.
- The inverter, motor and wiring generate electric noise. Take care of malfunction of the nearby sensors and devices. To prevent the motor from malfunctioning, implement noise control measures.
Otherwise an accident could occur.

WARNING

- Be sure to install the terminal block cover and the front cover before turning the power ON. Do not remove the covers while power is applied.

Otherwise electric shock could occur.

- Do not operate switches with wet hands.

Doing so could cause electric shock.



- If the retry function has been selected, the inverter may automatically restart and drive the motor depending on the cause of tripping.

(Design the machinery or equipment so that human safety is ensured after restarting.)

- If the stall prevention function (current limiter), automatic deceleration, and overload prevention control have been selected, the inverter may operate at an acceleration/deceleration time or frequency different from the commanded ones. Design the machine so that safety is ensured even in such cases.

Otherwise an accident could occur.

- The  key on the keypad is effective only when the keypad operation is enabled with function code F02 (= 0, 2 or 3). When the keypad operation is disabled, prepare an emergency stop switch separately for safe operations.

Switching the run command source from keypad (local) to external equipment (remote) by turning ON the "Enable communications link" command (LE) or "Switch run command 2/1" command (FR2/FR1), disables the  key. To enable the  key for an emergency stop, select the STOP key priority with function code H96 (= 1 or 3).

- If an alarm reset is made with the Run command signal turned ON, a sudden start will occur. Ensure that the Run command signal is turned OFF in advance.

Otherwise an accident could occur.

- If you enable the "Restart mode after momentary power failure" (Function code F14 = 3, 4, or 5), then the inverter automatically restarts running the motor when the power is recovered.

(Design the machinery or equipment so that human safety is ensured after restarting.)

- If you set the function codes wrongly or without completely understanding this instruction manual and the FRENIC-Eco User's Manual (MEH456), the motor may rotate with a torque or at a speed not permitted for the machine.

An accident or injuries could occur.

- Do not touch the inverter terminals while the power is applied to the inverter even if the inverter stops.

Doing so could cause electric shock.

CAUTION

- Do not turn the main circuit power (circuit breaker) ON or OFF in order to start or stop inverter operation.
Doing so could cause failure.
- Do not touch the heat sink because they become very hot.
Doing so could cause burns.
- Setting the inverter to high speeds is easy. Before changing the frequency (speed) setting, check the specifications of the motor and machinery.
- The brake function of the inverter does not provide mechanical holding means.
Injuries could occur.

Setting control switches

WARNING

- Before setting up any internal control switches, turn OFF the power and wait more than five minutes for models of 30 kW or below, or ten minutes for models of 37 kW or above. Make sure that the LED monitor and charging lamp (on models of 37 kW or above) are turned OFF. Further, make sure, using a multimeter or a similar instrument, that the DC link bus voltage between the terminals P (+) and N (-) has dropped below the safe voltage (+25 VDC).
Otherwise electric shock could occur.

Maintenance and inspection, and parts replacement

WARNING

- Turn the power OFF and wait for at least five minutes for models of 30 kW or below, or ten minutes for models of 37 kW or above, before starting inspection. Further, check that the LED monitor and charging lamp (on models of 37 kW or above) are unlit and that the DC link bus voltage between the P (+) and N (-) terminals is lower than 25 VDC.
Otherwise, electric shock could occur.
- Maintenance, inspection, and parts replacement should be made only by qualified persons.
- Take off the watch, rings and other metallic objects before starting work.
- Use insulated tools.
Otherwise, electric shock or injuries could occur.

Disposal

CAUTION

- Treat the inverter as an industrial waste when disposing of it.
Otherwise injuries could occur.

Others

WARNING

- Never attempt to modify the inverter.
Doing so could cause electric shock or injuries.

GENERAL PRECAUTIONS

Drawings in this manual may be illustrated without covers or safety shields for explanation of detail parts. Restore the covers and shields in the original state and observe the description in the manual before starting operation.

Conformity with Low Voltage Directive in the EU

If installed according to the guidelines given below, inverters marked with CE can be considered to be compliant with the Low Voltage Directive 2006/95/EC.

CAUTION

1. Be sure to earth the grounding terminal G. Use an earth wire sized more than that of the power wires used in the power dispatch system. Do not use a residual-current-operated protective device (RCD)* or an earth leakage circuit breaker (ELCB)* as a sole mechanism of electric shock protection.
*With overcurrent protection.
2. Use an MCCB, RCD/ELCB or MC in conformity with EN or IEC standards.
3. When an RCD/ELCB is used for protection of electric shock caused by a direct or indirect contact to the live parts, insert a **type B RCD/ELCB** in input lines (primary) of the inverter for the 3-phase 200 V or 400 V power source.
4. Use inverters in an environment that does not exceed pollution degree 2. If inverters are to be used in an environment with pollution degree 3 or 4, place them in an enclosure of IP54 or above.
5. To protect human body from an electric shock caused by a contact to live parts, install inverters, AC reactor and input/output filter in the enclosure of IP2X. In the case where human body easily contacts to live parts, a top panel of the enclosure should be IP4X or higher.
6. Do not directly connect a copper wire to the grounding terminal. Use a crimp terminal with tin or equivalent plating to connect the earth wire.
7. When using inverters at an altitude of more than 2000 m, note that the basic insulation applies to the insulation degree of the control circuitry. At an altitude of more than 3000 m, inverters cannot be used.

Conformity with Low Voltage Directive in the EU (continued)



8. Use the wires listed in EN60204 Appendix C.

Power supply voltage	Nominal applied motor (kW)	Inverter type	MCCB or RCD/ELCB *1 Rated current (A)		Recommended wire size (mm ²)							
					Main power input *2 [L1/R, L2/S, L3/T] Inverter's grounding [⊕G]		Inverter outputs *2 [U, V, W]	DC reactor [P1, P(+)]	Control circuit		Aux. control power supply [R0, T0]	Aux. fan power supply [R1, T1]
					W/DCR	W/o DCR			W/DCR	W/o DCR		
Three-phase 200 V	0.75	FRN0.75F1S-2□	5	10	2.5	2.5	2.5	2.5	0.25 to 0.75	0.25 to 0.75	2.5	-
	1.5	FRN1.5F1S-2□	10	15								
	2.2	FRN2.2F1S-2□		20								
	3.7	FRN3.7F1S-2□	20	30								
	5.5	FRN5.5F1S-2□	30	50	4.0	6.0	4.0	4.0				
	7.5	FRN7.5F1S-2□	40	75	6.0	10	6.0	6.0				
	11	FRN11F1S-2□	50	100	10	16	10	16				
	15	FRN15F1S-2□	75	125	16	25	16	25				
	18.5	FRN18.5F1S-2□	100	150	25	35	25	35				
	22	FRN22F1S-2□		175	35	50	35	35				
	30	FRN30F1S-2□	150	200	50	70	50	70				
	37	FRN37F1S-2□	175	250	25x2	50x2	25x2	25x2				
	45	FRN45F1S-2□	200	300	95	70x2	95	120				
	55	FRN55F1S-2□	250	350	50x2	95x2	70x2	150				
75	FRN75F1S-2□	350	-	95x2	-	95x2	95x2					
Three-phase 400 V	0.75	FRN0.75F1S-4□	5	5	2.5	2.5	2.5	2.5	0.25 to 0.75	0.25 to 0.75	2.5	-
	1.5	FRN1.5F1S-4□		10								
	2.2	FRN2.2F1S-4□	15									
	3.7 (4.0)*3	FRN3.7F1S-4□ FRN4.0F1S-4E	10	20								
	5.5	FRN5.5F1S-4□	15	30								
	7.5	FRN7.5F1S-4□	20	40	4.0							
	11	FRN11F1S-4□	30	50	4.0	6.0	4.0	4.0				
	15	FRN15F1S-4□	40	60	6.0	10	6.0	6.0				
	18.5	FRN18.5F1S-4□		75	10	10						
	22	FRN22F1S-4□	50	100	10	16	10	16				
	30	FRN30F1S-4□	75	125	16	25	16	25				
	37	FRN37F1S-4□	100	25	35	25	25	25				
	45	FRN45F1S-4□		150	50	35	35					
	55	FRN55F1S-4□	125	200	35	25x2	50	16x2				
	75	FRN75F1S-4□	175	-	25x2	-	25x2	25x2				
	90	FRN90F1S-4□	200	-	95	-	95	120				
	110	FRN110F1S-4□	250	-	50x2	-	50x2	150				
	132	FRN132F1S-4□	300	-	-	-	70x2	70x2				
160	FRN160F1S-4□	350	-	185	-	240	300					
200	FRN200F1S-4□	500	-	300	-	300	185x2					
220	FRN220F1S-4□		-	120x2								

Note: A box (□) in the above table replaces A, K, or E depending on the shipping destination.

*1 The frame size and model of the MCCB or RCD/ELCB (with overcurrent protection) will vary, depending on the power transformer capacity. Refer to the related technical documentation for details.

*2 The recommended wire size for main circuits is for the 70°C 600V PVC wires used at an ambient temperature of 40°C.

*3 The applicable motor rating of FRN4.0F1S-4E to be shipped for EU is 4.0 kW.

Conformity with UL standards and CSA standards (cUL-listed for Canada)

UL/cUL-listed inverters are subject to the regulations set forth by the UL standards and CSA standards (cUL-listed for Canada) by installation within precautions listed below.

⚠ CAUTION

Integral solid state short circuit protection does not provide branch circuit protection. Branch circuit protection must be provided in accordance with the National Electrical Code and any additional local codes.

1. Solid state motor overload protection (motor protection by electronic thermal overload relay) is provided in each model.
Adjust function codes F10 to F12 to decide the protection level.
2. Suitable for use on a circuit capable of delivering not more than 100,000 rms symmetrical amperes, 240 V maximum for 200 V class input 30 kW or less, 230 V maximum for 200 V class input 37 kW or above when protected by Class J Fuses or a Circuit Breaker having an interrupting rating not less than 100,000 rms symmetrical amperes, 240 V maximum.
Suitable for use on a circuit capable of delivering not more than 100,000 rms symmetrical amperes, 480 V maximum for 400 V class input when protected by Class J Fuses or a Circuit Breaker having an interrupting rating not less than 100,000 rms symmetrical amperes, 480 V maximum.
3. Use 60°C/75°C Cu wire only.
4. Use Class 1 wire only.
5. Field wiring connections must be made by a UL Listed and CSA Certified closed-loop terminal connector sized for the wire gauge involved. Connector must be fixed using the crimp tool specified by the connector manufacturer.
6. All circuits with terminals L1/R, L2/S, L3/T, R0, T0, R1, T1 must have a common disconnect and be connected to the same pole of the disconnect if the terminals are connected to the power supply.

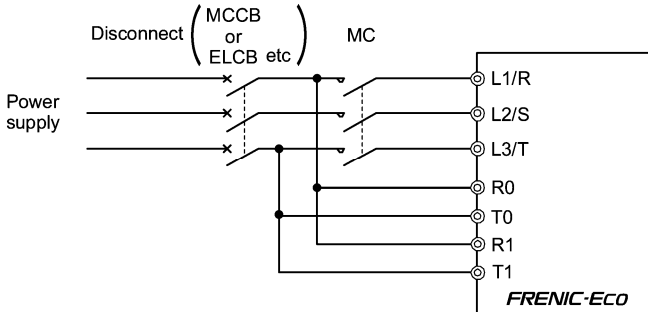

Conformity with UL standards and CSA standards (cUL-listed for Canada) (continued)

⚠ CAUTION

7. Install UL-listed fuses or circuit breaker between the power supply and the inverter, referring to the table below.

Power supply voltage	Inverter type	Required torque lb-in (N·m)			Wire size AWG (mm ²)					Class J fuse size (A)	Circuit breaker trip size (A)	
		Main terminal	Aux. Control Power Supply R0, T0	Control circuit		Main terminal	Aux. Control Power Supply R0, T0	Aux. Fan Power Supply R1, T1	Control circuit			
				Screw terminal base	Europe type terminal block				Screw terminal base			Europe type terminal block
Three-phase 200 V	FRN0.75F1S-2□	15.9 (1.8)	10.6 (1.2)	6.1 (0.7)	4.4 (0.5)	14 (2.1)	14 (2.1)	-	20 (0.5)	20 (0.5)	15	10
	FRN1.5F1S-2□										20	15
	FRN2.2F1S-2□										30	20
	FRN3.7F1S-2□										40	30
	FRN5.5F1S-2□	33.6 (3.8)				12 (3.3)			10 (5.3)	8 (8.4)	60	50
	FRN7.5F1S-2□					4 (21.2)			100	100		
	FRN11F1S-2□					3 (26.7)			150	125		
	FRN15F1S-2□	51.3 (5.8)				2 (33.6)			1/0 (53.5)	4/0 (107.2)	175	150
	FRN18.5F1S-2□					1x2 (42.4)			200	175		
	FRN22F1S-2□	119.4 (13.5)				2/0x2 (67.4)			4/0x2 (107.2)	250	200	
	FRN30F1S-2□					238.9 (27)			14 (2.1)	*1	*1	
	FRN37F1S-2□											
	FRN45F1S-2□											
	FRN55F1S-2□											
FRN75F1S-2□												
Three-phase 400 V	FRN0.75F1S-4□	15.9 (1.8)	10.6 (1.2)	6.1 (0.7)	4.4 (0.5)	14 (2.1)	14 (2.1)	-	20 (0.5)	20 (0.5)	6	5
	FRN1.5F1S-4□										10	10
	FRN2.2F1S-4□										15	15
	FRN3.7F1S-4□										20	20
	FRN4.0F1S-4E*2	33.6 (3.8)				30			30			
	FRN5.5F1S-4□					40			40			
	FRN7.5F1S-4□					60			50			
	FRN11F1S-4□	51.3 (5.8)				12 (3.3)			10 (5.3)	8 (8.4)	70	60
	FRN15F1S-4□					6 (13.3)			100	100		
	FRN18.5F1S-4□	119.4 (13.5)				4 (21.2)			3 (26.7)	2 (33.6)	90	75
	FRN22F1S-4□					1/0 (53.5)			125	125		
	FRN30F1S-4□					2x2 (33.6)						
	FRN37F1S-4□	238.9 (27)				4/0 (107.2)			2/0x2 (67.4)	3/0x2 (85)	*1	*1
	FRN45F1S-4□					4/0 (107.2)						
	FRN55F1S-4□					2/0x2 (67.4)						
	FRN75F1S-4□	424.7 (48)				3/0x2 (85)			4/0x2 (107.2)	300x2 (152)		
	FRN90F1S-4□					400x2 (203)						
	FRN110F1S-4□											
	FRN132F1S-4□											
	FRN160F1S-4□											
FRN200F1S-4□												
FRN220F1S-4□												

Note: A box (□) in the above table replaces A, K, or E depending on the shipping destination.

- *1 Select the rated current of a fuse or a circuit breaker which is suitable to the connecting wire size.
- *2 The applicable motor rating of FRN4.0F1S-4E to be shipped for EU is 4.0 kW.

■ Precautions for use

In running general-purpose motors	Driving a 400V general-purpose motor	When driving a 400V general-purpose motor with an inverter using extremely long wires, damage to the insulation of the motor may occur. Use an output circuit filter (OFL) if necessary after checking with the motor manufacturer. Fuji motors do not require the use of output circuit filters because of their reinforced insulation.
	Torque characteristics and temperature rise	When the inverter is used to run a general-purpose motor, the temperature of the motor becomes higher than when it is operated using a commercial power supply. In the low-speed range, the cooling effect will be weakened, so decrease the output torque of the motor.
	Vibration	When an inverter-driven motor is mounted to a machine, resonance may be caused by the natural frequencies of the machine system. Note that operation of a 2-pole motor at 60 Hz or higher may cause abnormal vibration. * The use of a rubber coupling or vibration dampening rubber is recommended. * Use the inverter's jump frequency control feature to skip the resonance frequency zone(s).
	Noise	When an inverter is used with a general-purpose motor, the motor noise level is higher than that with a commercial power supply. To reduce noise, raise carrier frequency of the inverter. Operation at 60 Hz or higher can also result in higher noise level.
In running special motors	Explosion-proof motors	When driving an explosion-proof motor with an inverter, use a combination of a motor and an inverter that has been approved in advance.
	Submersible motors and pumps	These motors have a larger rated current than general-purpose motors. Select an inverter whose rated output current is greater than that of the motor. These motors differ from general-purpose motors in thermal characteristics. Set a low value in the thermal time constant of the motor when setting the electronic thermal function.
	Brake motors	For motors equipped with parallel-connected brakes, their braking power must be supplied from the primary circuit. If the brake power is connected to the inverter's output circuit by mistake, the brake will not work. Do not use inverters for driving motors equipped with series-connected brakes.
	Geared motors	If the power transmission mechanism uses an oil-lubricated gearbox or speed changer/reducer, then continuous motor operation at low speed may cause poor lubrication. Avoid such operation.
	Synchronous motors	It is necessary to take special measures suitable for this motor type. Contact your Fuji Electric representative for details.
	Single-phase motors	Single-phase motors are not suitable for inverter-driven variable speed operation. Use three-phase motors.
Environmental conditions	Installation location	Use the inverter within the ambient temperature range from -10 to +50°C. The heat sink of the inverter may become hot under certain operating conditions, so install the inverter on nonflammable material such as metal. Ensure that the installation location meets the environmental conditions specified in Chapter 2, Section 2.1 "Operating Environment."

Combination with peripheral devices	Installing an MCCB or RCD/ELCB	Install a recommended molded case circuit breaker (MCCB) or residual-current-operated protective device (RCD)/earth leakage circuit breaker (ELCB) (with overcurrent protection) in the primary circuit of the inverter to protect the wiring. Ensure that the circuit breaker rated current is equivalent to or lower than the recommended rated current.
	Installing an MC in the secondary circuit	If a magnetic contactor (MC) is mounted in the inverter's output (secondary) circuit for switching the motor to commercial power or for any other purpose, ensure that both the inverter and the motor are completely stopped before you turn the MC ON or OFF. Remove the magnet contactor (MC) already installed and built-in surge killer from the inverter's output (secondary) circuit before installing the MC to switch the motor power.
	Installing an MC in the primary circuit	Do not turn the magnetic contactor (MC) in the primary circuit ON or OFF more than once an hour as an inverter failure may result. If frequent starts or stops are required during motor operation, use (FWD)/(REV) signals or the RUN/STOP key.
	Protecting the motor	The electronic thermal function of the inverter can protect the motor. The operation level and the motor type (general-purpose motor, inverter motor) should be set. For high-speed motors or water-cooled motors, set a small value for the thermal time constant and protect the motor. If you connect the motor thermal relay to the motor with a long wire, a high-frequency current may flow into the wiring stray capacitance. This may cause the relay to trip at a current lower than the set value for the thermal relay. If this happens, lower the carrier frequency or use the output circuit filter (OFL).
	Discontinuance of power-factor correcting capacitor	Do not mount power-factor correcting capacitors in the inverter's primary circuit. (Use the DC reactor to improve the inverter power factor.) Do not use power-factor correcting capacitors in the inverter's output (secondary) circuit. An overcurrent trip will occur, disabling motor operation.
	Discontinuance of surge killer	Do not connect a surge killer to the inverter's output (secondary) circuit.
	Reducing noise	Use of a filter and shielded wires is typically recommended to satisfy EMC Directives.
	Measures against surge currents	If an overvoltage trip occurs while the inverter is stopped or operated under a light load, it is assumed that the surge current is generated by open/close of the power-factor correcting capacitor in the power system. * Connect a DC reactor to the inverter.
Megger test	When checking the insulation resistance of the inverter, use a 500 V megger and follow the instructions contained in Chapter 7, Section 7.5 "Insulation Test."	
Wiring	Control circuit wiring length	When using remote control, limit the wiring length between the inverter and operator box to 20 m or less and use twisted pair or shielded wire.
	Wiring length between inverter and motor	If long wiring is used between the inverter and the motor, the inverter will overheat or trip as a result of overcurrent (high-frequency current flowing into the stray capacitance) in the wires connected to the phases. Ensure that the wiring is shorter than 50 m. If this length must be exceeded, lower the carrier frequency or mount an output circuit filter (OFL).
	Wiring size	Select wires with a sufficient capacity by referring to the current value or recommended wire size.
	Wiring type	When several inverters drive motors, do not use one multicore cable in order to connect several inverters with motors.
	Grounding	Securely ground the inverter using the grounding terminal.

Selecting inverter capacity	Driving general-purpose motor	Select an inverter according to the applicable motor ratings listed in the standard specifications table for the inverter. When high starting torque is required or quick acceleration or deceleration is required, select an inverter with a capacity one size greater than the standard.
	Driving special motors	Select an inverter that meets the following condition: Inverter rated current > Motor rated current
Transportation and storage	When transporting or storing inverters, follow the procedures and select locations that meet the environmental conditions listed in Chapter 1, Section 1.3 "Transportation" and Section 1.4 "Storage Environment."	

How this manual is organized

This manual is made up of chapters 1 through 10.

Chapter 1 BEFORE USING THE INVERTER

This chapter describes acceptance inspection and precautions for transportation and storage of the inverter.

Chapter 2 MOUNTING AND WIRING OF THE INVERTER

This chapter provides operating environment, precautions for installing the inverter, wiring instructions for the motor and inverter.

Chapter 3 OPERATION USING THE KEYPAD

This chapter describes inverter operation using the keypad. The inverter features three operation modes (Running, Programming and Alarm modes) which enable you to run and stop the motor, monitor running status, set function code data, display running information required for maintenance, and display alarm data.

Chapter 4 OPERATION

This chapter describes preparation to be made before running the motor for a test and practical operation.

Chapter 5 FUNCTION CODES

This chapter provides a list of the function codes. Function codes to be used often and irregular ones are described individually.

Chapter 6 TROUBLESHOOTING

This chapter describes troubleshooting procedures to be followed when the inverter malfunctions or detects an alarm condition. In this chapter, first check whether any alarm code is displayed or not, and then proceed to the troubleshooting items.

Chapter 7 MAINTENANCE AND INSPECTION

This chapter describes inspection, measurement and insulation test which are required for safe inverter operation. It also provides information about periodical replacement parts and guarantee of the product.

Chapter 8 SPECIFICATIONS

This chapter lists specifications including output ratings, control system, external dimensions and protective functions.

Chapter 9 LIST OF PERIPHERAL EQUIPMENT AND OPTIONS

This chapter describes main peripheral equipment and options which can be connected to the FRENIC-Eco series of inverters.

Chapter 10 CONFORMITY WITH STANDARDS

This chapter describes standards with which the FRENIC-Eco series of inverters comply.

Icons

The following icons are used throughout this manual.

 **Note** This icon indicates information which, if not heeded, can result in the inverter not operating to full efficiency, as well as information concerning incorrect operations and settings which can result in accidents.

 **Tip** This icon indicates information that can prove handy when performing certain settings or operations.

 This icon indicates a reference to more detailed information.

Table of Contents

Preface	i	Chapter 5 FUNCTION CODES	5-1
■ Safety precautions	i	5.1 Function Code Tables	5-1
■ Precautions for use	x	5.2 Overview of Function Codes	5-22
How this manual is organized	xiii	Chapter 6 TROUBLESHOOTING	6-1
Chapter 1 BEFORE USING THE INVERTER	1-1	6.1 Before Proceeding with Troubleshooting	6-1
1.1 Acceptance Inspection	1-1	6.2 If No Alarm Code Appears on the LED Monitor	6-2
1.2 External View and Terminal Blocks	1-2	6.2.1 Motor is running abnormally	6-2
1.3 Transportation	1-4	6.2.2 Problems with inverter settings	6-7
1.4 Storage Environment	1-4	6.3 If an Alarm Code Appears on the LED Monitor	6-8
1.4.1 Temporary storage	1-4	6.4 If an Abnormal Pattern Appears on the LED	
1.4.2 Long-term storage	1-4	Monitor while No Alarm Code is Displayed	6-20
Chapter 2 MOUNTING AND WIRING OF		Chapter 7 MAINTENANCE AND INSPECTION	7-1
THE INVERTER	2-1	7.1 Daily Inspection	7-1
2.1 Operating Environment	2-1	7.2 Periodic Inspection	7-1
2.2 Installing the Inverter	2-1	7.3 List of Periodical Replacement Parts	7-3
2.3 Wiring	2-6	7.3.1 Judgment on service life	7-3
2.3.1 Removing and mounting the terminal		7.4 Measurement of Electrical Amounts	
block (TB) cover and the front cover	2-6	in Main Circuit	7-5
2.3.2 Removing and mounting the cable guide		7.5 Insulation Test	7-6
plate (for models of 0.75 kW to 22 kW)	2-10	7.6 Inquiries about Product and Guarantee	7-7
2.3.3 Terminal arrangement diagram and screw speci-		Chapter 8 SPECIFICATIONS	8-1
fications	2-11	8.1 Standard Models	8-1
2.3.4 Recommended wire sizes	2-14	8.1.1 Three-phase 200 V series	8-1
2.3.5 Wiring precautions	2-15	8.1.2 Three-phase 400 V series	8-2
2.3.6 Wiring for main circuit terminals and		8.2 Specifications of Keypad Related	8-4
grounding terminals	2-15	8.2.1 General specifications of keypad	8-4
2.3.7 Wiring for control circuit terminals	2-23	8.2.2 Communications specifications of keypad	8-4
2.3.8 Setting up slide switches and handling		8.2.3 Data transmission specifications	8-5
control circuit terminal symbol plate	2-32	8.3 Common Specifications	8-6
2.4 Mounting and Connecting a Keypad	2-34	8.4 Terminal Specifications	8-8
2.4.1 Mounting style and parts needed		8.4.1 Terminal functions	8-8
for connection	2-34	8.4.2 Running the inverter with keypad	8-9
2.4.2 Mounting/installing steps	2-35	8.4.3 Running the inverter by terminal	
2.5 Cautions Relating to Harmonic Component,		commands	8-10
Noise, and Leakage Current	2-37	8.5 External Dimensions	8-12
Chapter 3 OPERATION USING THE KEYPAD	3-1	8.5.1 Standard models	8-12
3.1 LED Monitor, Keys and LED Indicators		8.5.2 DC reactor	8-15
on the Keypad	3-1	8.5.3 Keypad	8-16
3.2 Overview of Operation Modes	3-2	8.6 Protective Functions	8-17
3.3 Running Mode	3-4	Chapter 9 LIST OF PERIPHERAL EQUIPMENT AND OP-	
3.3.1 Monitoring the running status	3-4	TIONS	9-1
3.3.2 Setting up frequency and PID		Chapter 10 CONFORMITY WITH STANDARDS	10-1
process commands	3-5	10.1 Conformity with UL Standards and Canadian Stan-	
3.3.3 Running/stopping the motor	3-8	dards (cUL-listed for Canada)	10-1
3.4 Programming Mode	3-10	10.1.1 General	10-1
3.4.1 Setting up basic function codes quickly		10.1.2 Considerations when using FRENIC-Eco	
– Menu #0 "Quick Setup"	3-12	as a product certified by UL or cUL	10-1
3.4.2 Setting up function codes		10.2 Conformity with EU Directives	10-1
– Menu #1 "Data Setting"	3-14	10.3 Conformity with Low Voltage Directive	10-1
3.4.3 Checking changed function codes		10.3.1 General	10-1
– Menu #2 "Data Checking"	3-16	10.3.2 Considerations when using FRENIC-Eco	
3.4.4 Monitoring the running status		as a product in conformity with	
– Menu #3 "Drive Monitoring"	3-17	Low Voltage Directive	10-1
3.4.5 Checking I/O signal status		10.4 Harmonic Component Regulation in the EU	10-2
– Menu #4 "I/O Checking"	3-20	10.4.1 General	10-2
3.4.6 Reading maintenance information		10.4.2 Conformity with the harmonics regulation	10-2
– Menu #5 "Maintenance Information"	3-24	10.5 Conformity with the EMC Directive in the EU	10-3
3.4.7 Reading alarm information		10.5.1 General	10-3
– Menu #6 "Alarm Information"	3-27	10.5.2 EMC-compliant filter (Option)	10-3
3.4.8 Data copying information		10.5.3 Recommended installation of	
– Menu #7 "Data Copying"	3-29	EMC-compliant filter	10-5
3.5 Alarm Mode	3-32	10.5.4 EMC-compliant environment and class	10-6
Chapter 4 RUNNING THE MOTOR	4-1		
4.1 Running the Motor for a Test	4-1		
4.1.1 Inspection and preparation prior to			
powering on	4-1		
4.1.2 Turning ON power and checking	4-1		
4.1.3 Preparation before running the motor			
for a test--Setting function code data	4-1		
< Tuning procedure >	4-2		
■ Errors during tuning	4-3		
4.1.4 Test run	4-4		
4.2 Operation	4-4		

1.2 External View and Terminal Blocks

(1) Outside and inside views

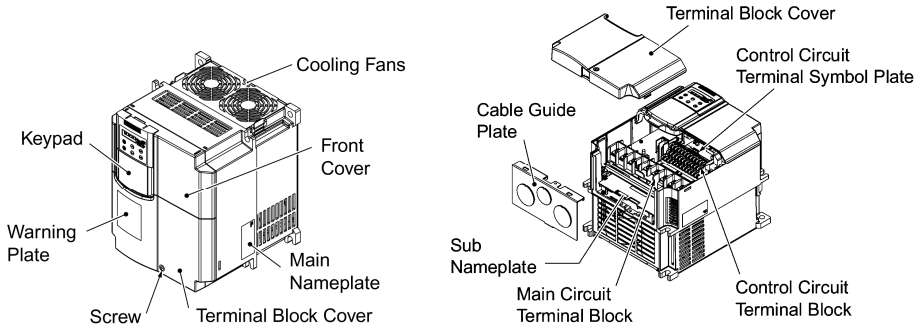

(a) FRN15F1S-2□

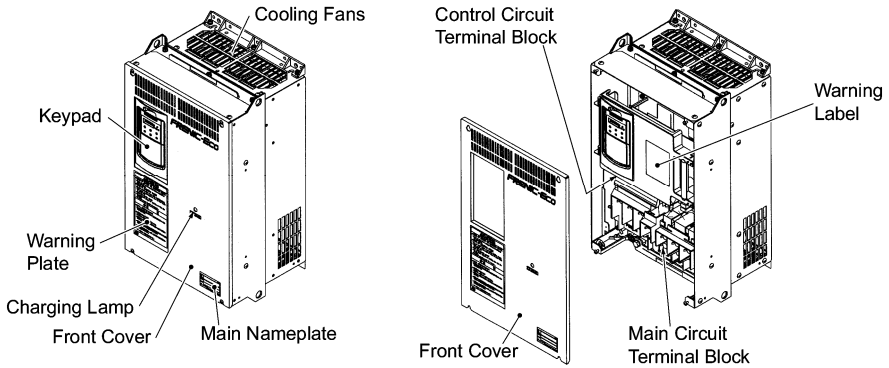

(b) FRN37F1S-2□

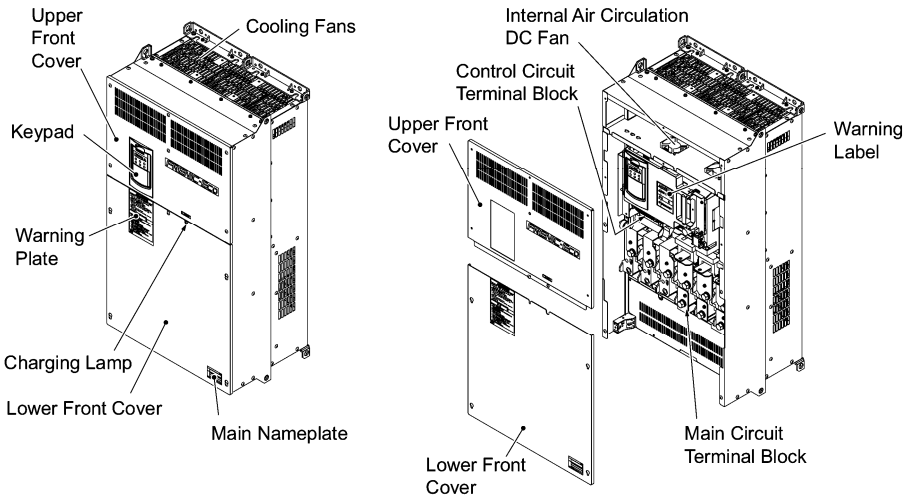

(c) FRN220F1S-4□

Note: A box (□) in the above model names replaces A, K, or E depending on the shipping destination.

Figure 1.2 Outside and Inside Views of Inverters

(2) Warning plates and label



Warning Plate

(a) FRN15F1S-2□



Warning Plate

(b) FRN37F1S-2□



Warning Label

Note: A box (□) in the above model names replaces A, K, or E depending on the shipping destination.

Figure 1.3 Warning Plates and Label

(3) Terminal block location

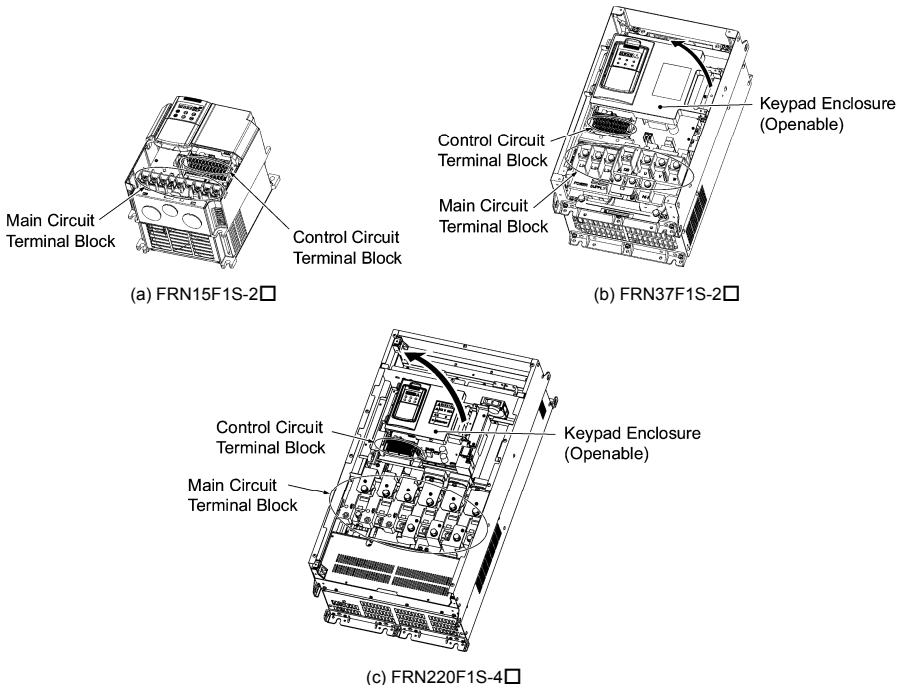

(c) FRN220F1S-4□

Note: A box (□) in the above model names replaces A, K, or E depending on the shipping destination.

Figure 1.4 Terminal Blocks and Keypad Enclosure Location

1.3 Transportation

- When carrying an inverter, always support its bottom at the front and rear sides with both hands. Do not hold covers or individual parts only. You may drop the inverter or break it.
- When hoisting an inverter with hoisting holes, hook or rope the 4 holes evenly.

1.4 Storage Environment

1.4.1 Temporary storage

Store the inverter in an environment that satisfies the requirements listed in Table 1.1.

Table 1.1 Environmental Requirements for Storage and Transportation

Item	Requirements	
Storage temperature * ¹	-25 to +70°C	A location where the inverter is not subject to abrupt changes in temperature that would result in the formation of condensation or ice.
Relative humidity	5 to 95% * ²	
Atmosphere	The inverter must not be exposed to dust, direct sunlight, corrosive or flammable gases, oil mist, vapor, water drops or vibration. The atmosphere must contain only a low level of salt. (0.01 mg/cm ² or less per year)	
Atmospheric pressure	86 to 106 kPa (in storage)	
	70 to 106 kPa (during transportation)	

*¹ Assuming a comparatively short storage period (e.g., during transportation or the like).

*² Even if the humidity is within the specified requirements, avoid such places where the inverter will be subjected to sudden changes in temperature that will cause condensation to form.

Precautions for temporary storage

- (1) Do not leave the inverter directly on the floor.
- (2) If the environment does not satisfy the specified requirements, wrap the inverter in an airtight vinyl sheet or the like for storage.
- (3) If the inverter is to be stored in an environment with a high level of humidity, put a drying agent (such as silica gel) in the airtight package described in item (2).

1.4.2 Long-term storage

The long-term storage methods for the inverter vary largely according to the environment of the storage site. General storage methods are described below.

- (1) The storage site must satisfy the requirements specified for temporary storage.
However, for storage exceeding three months, the ambient temperature should be within the range from -10 to +30 °C. This is to prevent the electrolytic capacitors in the inverter from deteriorating.
- (2) The inverter must be stored in a package that is airtight to protect it from moisture. Include a drying agent inside the package to maintain the relative humidity inside the package to within 70%.
- (3) If the inverter has been installed in the equipment or control board at a construction site where it may be subjected to humidity, dust or dirt, then remove the inverter and store it in a suitable environment specified in Table 1.1.

Precautions for storage over 1 year

If the inverter will not be powered on for a long time, the property of the electrolytic capacitors may deteriorate. Power the inverters on once a year and keep them on for 30 to 60 minutes. Do not connect the inverters to motors or run the motor.

Chapter 2 MOUNTING AND WIRING OF THE INVERTER

2.1 Operating Environment

Install the inverter in an environment that satisfies the requirements listed in Table 2.1.

Table 2.1 Environmental Requirements

Item	Specifications
Site location	Indoors
Ambient temperature	-10 to +50°C (Note 1)
Relative humidity	5 to 95% (No condensation)
Atmosphere	The inverter must not be exposed to dust, direct sunlight, corrosive gases, flammable gas, oil mist, vapor or water drops. Pollution degree 2 (IEC60664-1) (Note 2) The atmosphere can contain a small amount of salt. (0.01 mg/cm ² or less per year) The inverter must not be subjected to sudden changes in temperature that will cause condensation to form.
Altitude	1,000 m max. (Note 3)
Atmospheric pressure	86 to 106 kPa
Vibration	For inverters of 75 kW or below 3 mm (Max. amplitude) 2 to less than 9 Hz 9.8 m/s ² 9 to less than 20 Hz 2 m/s ² 20 to less than 55 Hz 1 m/s ² 55 to less than 200 Hz For inverters of 90 kW or above 3 m/s ² (Max. amplitude) 2 to less than 9 Hz 2 m/s ² 9 to less than 55 Hz 1 m/s ² 55 to less than 200 Hz

Table 2.2 Output Current Derating Factor in Relation to Altitude

Altitude	Output current derating factor
1000 m or lower	1.00
1000 to 1500 m	0.97
1500 to 2000 m	0.95
2000 to 2500 m	0.91
2500 to 3000 m	0.88

(Note 1) When inverters are mounted side-by-side without any gap between them (5.5 kW or less), the ambient temperature should be within the range from -10 to +40°C.

(Note 2) Do not install the inverter in an environment where it may be exposed to cotton waste or moist dust or dirt which will clog the heat sink in the inverter. If the inverter is to be used in such an environment, install it in the enclosure of your system or other dustproof containers.

(Note 3) If you use the inverter in an altitude above 1000 m, you should apply an output current derating factor as listed in Table 2.2.

2.2 Installing the Inverter

(1) Mounting base

The temperature of the heat sink will rise up to approx. 90°C during operation of the inverter, so the inverter should be mounted on a base made of material that can withstand temperatures of this level.

 WARNING
Install the inverter on a base constructed from metal or other non-flammable material. A fire may result with other material.

(2) Clearances

Ensure that the minimum clearances indicated in Figure 2.1 are maintained at all times. When installing the inverter in the enclosure of your system, take extra care with ventilation inside the enclosure as the temperature around the inverter will tend to increase. Do not install the inverter in a small enclosure with poor ventilation.



* 50 mm for models of 400 V series 90 KW or above

Figure 2.1 Mounting Direction and Required Clearances

■ When mounting two or more inverters

Horizontal layout is recommended when two or more inverters are to be installed in the same unit or enclosure. If it is necessary to mount the inverters vertically, install a partition plate or the like between the inverters so that any heat radiating from an inverter will not affect the one/s above. As long as the ambient temperature is 40°C or lower, inverters can be mounted side-by-side without any gap between them (only for inverters with a capacity of 5.5 kW or below).

■ When employing external cooling

At the shipment time, the inverter is set up for mount inside your equipment or enclosure so that cooling is done all internally.

To improve cooling efficiently, you can take the heat sink out of the equipment or the enclosure (as shown on the right) so that cooling is done both internally and externally (this is called "external cooling").

In external cooling, the heat sink, which dissipates about 70% of the total heat (total loss) generated into air, is situated outside the equipment or the enclosure. As a result, much less heat is radiated inside the equipment or the enclosure.

To take advantage of external cooling, you need to use the external cooling attachment option for inverters with a capacity of 30 kW or below, or simply re-position the mounting bases for the cooling unit for inverters with a capacity of 37 kW or above.

In an environment with high humidity or a lot of fibrous dust, however, do not use external cooling in an environment with high humidity or a lot of fibrous dust, which tends to clog the heat sink.

 For details, refer to the Mounting Adapter for External Cooling "PB-F1" Installation Manual (INR-SI47-0880) and FRENIC-Eco User's Manual (MEH456).

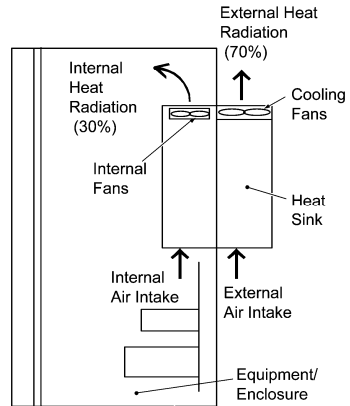

Figure 2.2 External Cooling

CAUTION

Prevent lint, paper fibers, sawdust, dust, metallic chips, or other foreign materials from getting into the inverter or from accumulating on the heat sink.

This may result in a fire or accident.

To utilize external cooling for inverters with a capacity of 37 kW or above, change the position of the top and bottom mounting bases from the edge to the center of the inverter as illustrated in Figure 2.3.

Screws differ in size, length and count for each inverter. Be sure to refer to the table below.

Table 2.3 Screw Count and Tightening Torque

Power supply voltage	Inverter type	Base fixing screw (Count)	Case fixing screw (Count)	Tightening torque (N·m)	Refer to:
3-phase 200 V	FRN37F1S-2□ to FRN75F1S-2□	M6 × 20 (3 pcs each for upper and lower sides)	M6 × 12 (3 pcs for upper side)	5.8	Figure A
3-phase 400 V	FRN37F1S-4□ to FRN110F1S-4□	M6 × 20 (3 pcs each for upper and lower sides)	M6 × 12 (3 pcs for upper side)	5.8	
	FRN132F1S-4□ to FRN220F1S-4□	M6 × 20 (2 pcs each for upper and lower sides) M5 × 16 (4 pcs each for upper and lower sides)	M6 × 20 (2 pcs each for upper and lower sides) M5 × 12 (4 pcs each for upper and lower sides)	5.8 3.5	Figure B

Note: A box (□) in the above table replaces A, K, or E depending on the shipping destination.

① For models shown in Figure A

- 1) Remove all of the base fixing screws from the top and bottom of the inverter. Also remove the case fixing screws from the top. (The case fixing screws are not necessary in external cooling. Store them for future use. On the bottom are no case fixing screws.)
- 2) Secure the top mounting base to the center of the inverter with the base fixing screws, using case fixing screw holes.
- 3) Secure the bottom mounting base to the center of the inverter with the base fixing screws.

② For models shown in Figure B

- 1) Remove all of the base fixing screws from the top and bottom of the inverter. Also remove the case fixing screws.
- 2) Secure the top mounting base to the center of the inverter with the base fixing screws, using case fixing screw holes. Set the removed case fixing screws to the screw holes where the top mounting bases were secured.
- 3) In the same way, secure the bottom mounting base to the center of the inverter.

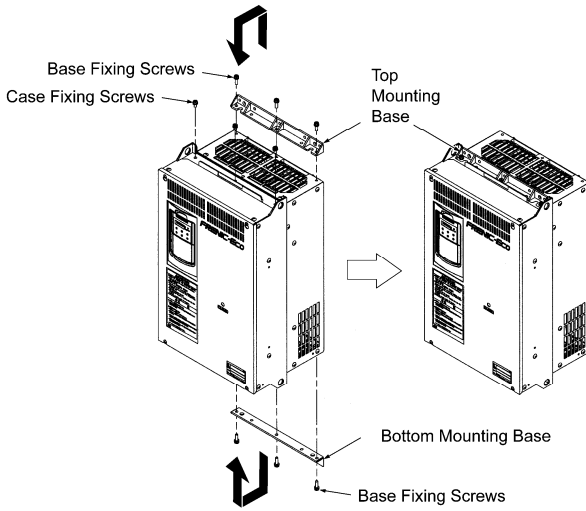

Figure A

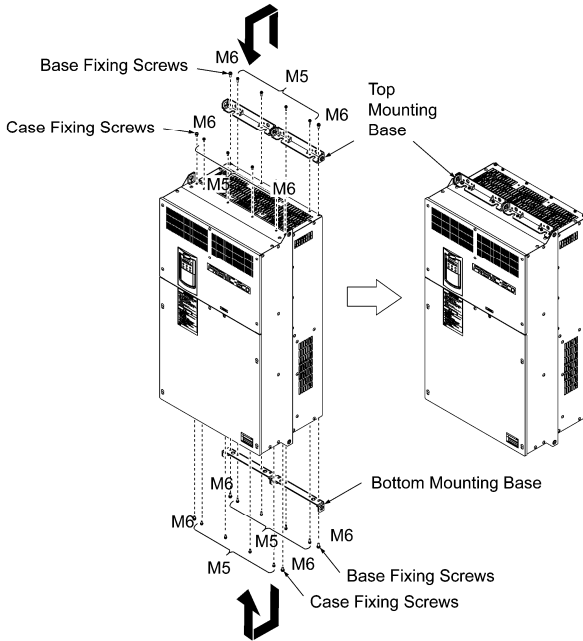

Figure B

Figure 2.3 Relocating the Top and Bottom Mounting Bases

CAUTION

When moving the top and bottom mounting bases, use only the specified screws.

A fire or an accident may be caused.

(3) Mounting direction

Mount the inverter vertically to the mounting surface and fix it securely with four screws or bolts so that the logo "FRENIC-Eco" can be seen from the front.

Note Do not mount the inverter upside down or horizontally. Doing so will reduce the heat dissipation efficiency of the inverter and cause the overheat protection function to operate, so the inverter will not run.

(4) Solving abnormal vibration after installation

If any vibration in the surroundings reaches the inverter and causes abnormal vibration to the cooling fan(s) or the keypad, fix them firmly using the fixing screws provided as accessories.

- Fixing the cooling fan(s)

Table 2.4 Fixing Screws

Power supply voltage	Nominal applied motor (kW)	Inverter type	Screw size (accessory)	Tightening torque (N·m)	Refer to:
Three-phase 200 V	7.5	FRN7.5F1S-2□	M4x35 (4 pcs)	0.8	Figure A
	11	FRN11F1S-2□			
	15	FRN15F1S-2□			
	18.5	FRN18.5F1S-2□	M4x50 (2 pcs)	0.5	Figure B
	22	FRN22F1S-2□			
30	FRN30F1S-2□				
Three-phase 400 V	7.5	FRN7.5F1S-4□	M4x35 (4 pcs)	0.8	Figure A
	11	FRN11F1S-4□			
	15	FRN15F1S-4□			
	18.5	FRN18.5F1S-4□	M4x50 (2 pcs)	0.5	Figure B
	22	FRN22F1S-4□			
30	FRN30F1S-4□				

Note: A box (□) in the above table replaces A, K, or E depending on the shipping destination.

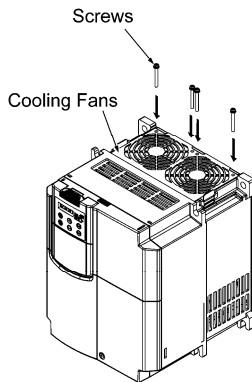

Figure A

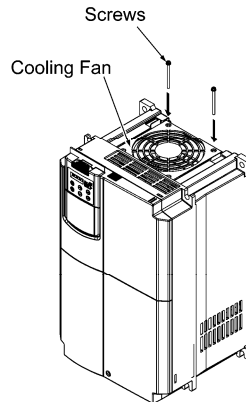
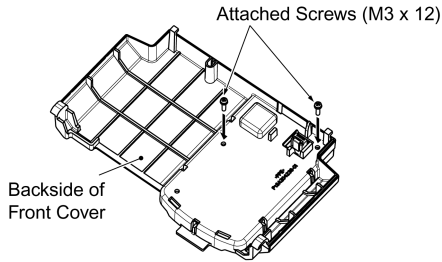

Figure B

Figure 2.4 Fixing the Cooling Fan(s)

■ Fixing the keypad (for models of 30 kW or below)

- ① Remove the terminal block (TB) cover and the front cover. (For the procedure, refer to 2.3.1 "Removing and mounting the terminal block (TB) cover and the front cover.")
- ② To fix the front cover and keypad, hold the front cover and the keypad together and tighten the two attached screws (provided as accessories) from the back of the keypad.



Tightening torque: 0.7 N·m

Figure 2.5 Fixing the Keypad

2.3 Wiring

Follow the procedure below. (In the following description, the inverter has already been installed.)

2.3.1 Removing and mounting the terminal block (TB) cover and the front cover

(1) For inverters with a capacity of 30 kW or below

■ Removing the covers

- ① To remove the terminal block (TB) cover, first loosen the TB cover fastening screw on it, and put your finger in the dimple of the terminal block (TB) cover (labeled "PULL"), and then pull it up toward you.
- ② To remove the front cover, hold it with both hands, slide it downward to unlatch. Tilt the front cover toward you, and pull it upward.

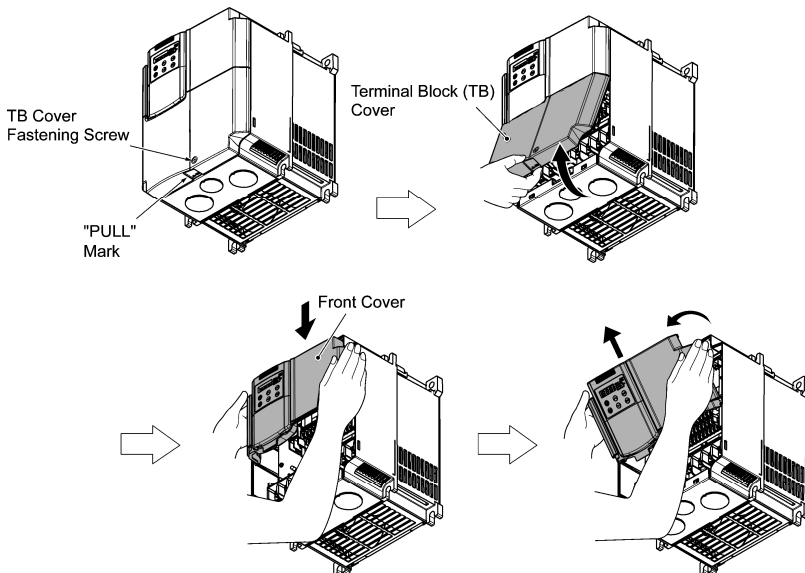

Figure 2.6 Removing the Covers (FRN15F1S-2□)*

* A box (□) replaces A, K, or E depending on the shipping destination.

■ Mounting the covers

- ① Put the front cover to the inverter case while fitting the edge of the front cover between the both hinges provided on the inverter case. Slide it upward until the front cover latches.
- ② Fit the latches on the terminal block (TB) cover in the holes provided to the front cover and push it towards the inverter case.
- ③ Tighten the TB cover fastening screw on the terminal block (TB) cover (Tightening torque: 1.8 N·m).

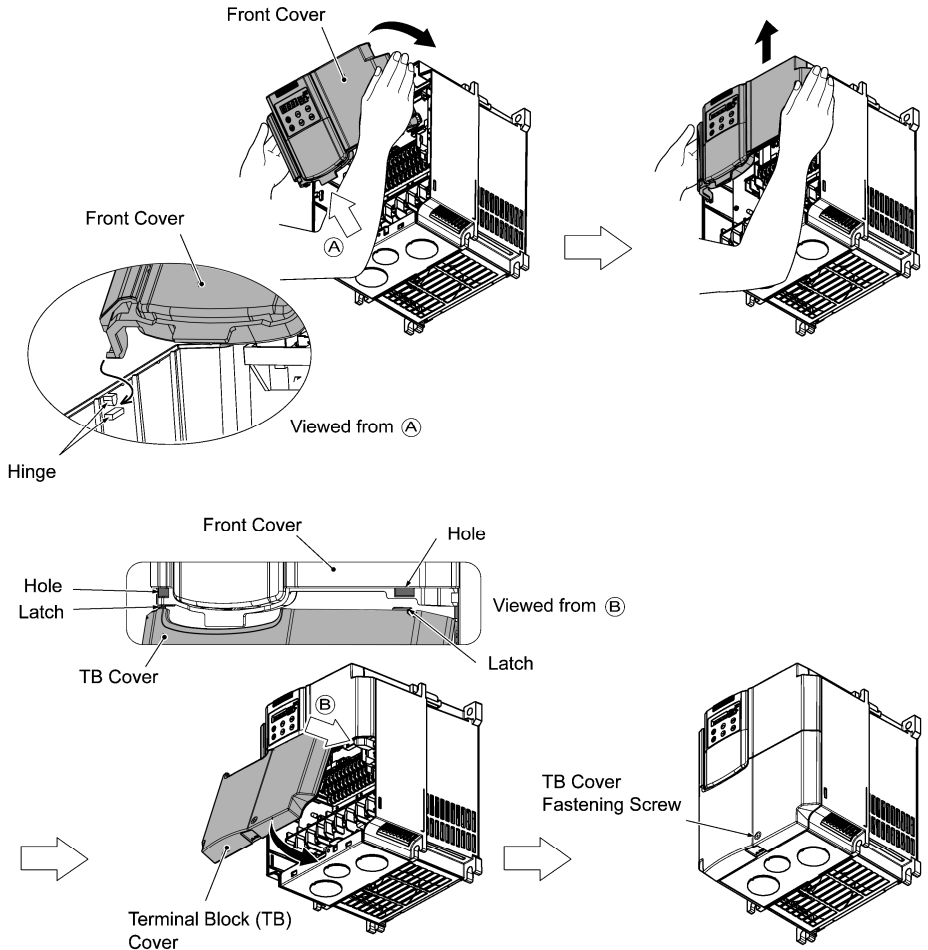

Figure 2.7 Mounting the Covers (FRN15F1S-2□)*

* A box (□) replaces A, K, or E depending on the shipping destination.

(2) For inverters with a capacity of 37 kW to 160 kW

■ Removing and mounting the covers

- ① To remove the front cover, loosen the four fastening screws on it, hold it with both hands, and slide it upward. (Refer to Figure 2.8.)
- ② Put the front cover back in reverse order of the ①. Make sure to properly match the position of the screw holes on both of the front cover and inverter case.

Table 2.5 Screw count and tightening torque

Power supply voltage	Inverter type	Front cover screw	Tightening torque (N·m)
Three-phase 200 V	FRN37F1S-2□ to FRN75F1S-2□	M4x8 (4 pcs)	1.8
Three-phase 400 V	FRN37F1S-4□ to FRN110F1S-4□	M4x8 (4 pcs)	1.8
	FRN132F1S-4□ to FRN160F1S-4□	M4x8 (4 pcs)	3.5

Note: A box (□) in the above table replaces A, K, or E depending on the shipping destination.

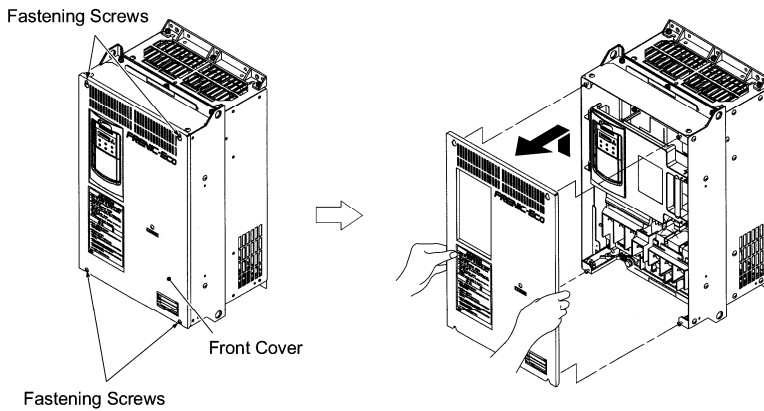

Figure 2.8 Removing the Front Cover (FRN37F1S-2□)*

* A box (□) replaces A, K, or E depending on the shipping destination.

(3) For inverters with a capacity of 200 kW to 220 kW

■ Removing and mounting the covers

- ① To remove the lower front cover, loosen the five fastening screws on it, and hold it with both hands, and then slide it upward.

Note You can do wiring works just removing the lower front cover.

- ② To remove the upper front cover, loosen the five screws on it while supporting it with a hand. Pull and remove it with both hands. (Refer to Figure 2.9.)
- ③ Put back the upper and lower front covers in reverse order of ① and ②. Make sure to properly match the position of the screw holes on the upper and lower front covers and inverter case.

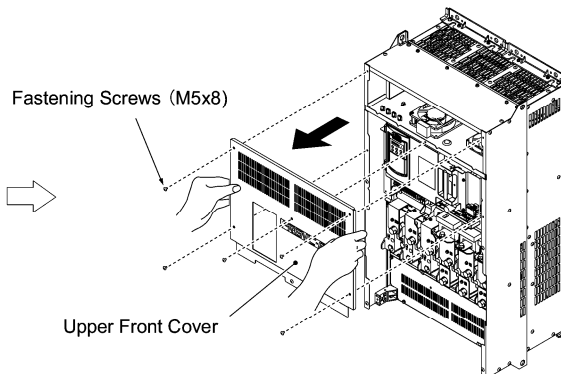
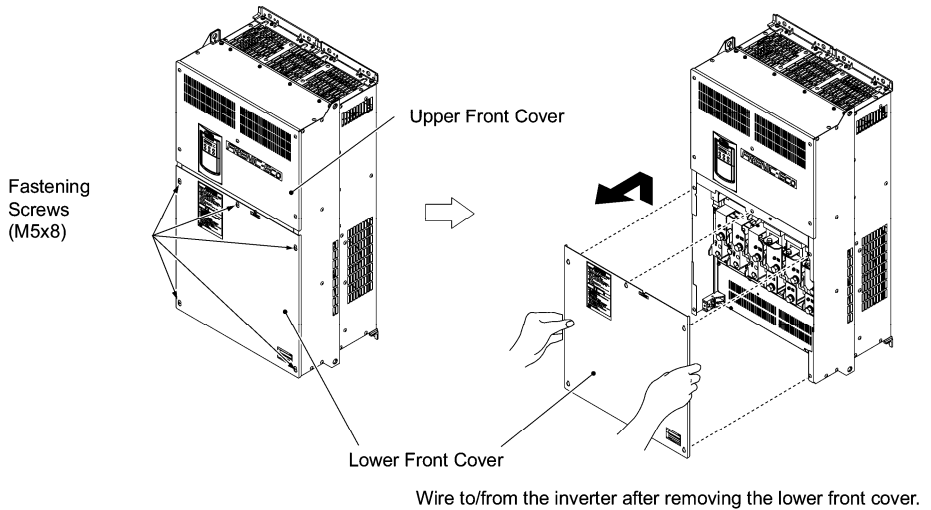

The upper front cover is removable as well as shown above.

Tightening torque: 3.5 N·m

Figure 2.9 Removing the Front Covers (FRN220F1S-4□)*

* A box (□) replaces A, K, or E depending on the shipping destination.

2.3.2 Removing and mounting the cable guide plate (for models of 0.75 kW to 22 kW)

For inverters of 22 kW or below use the cable guide plate to secure IP20 protective structure. Follow the steps to work on it.

■ Removing the cable guide plate

Before to proceed, remove the terminal block cover in advance.

Remove the cable guide plate fastening screw, and pull the cable guide plate.

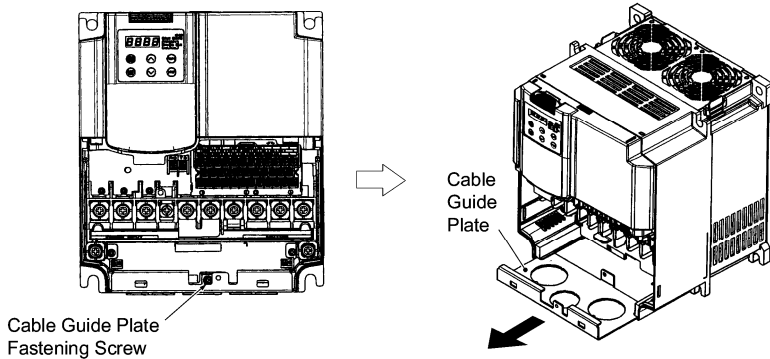

Figure 2.10 Removing the Cable Guide Plate (FRN15F1S-2□)*

* A box (□) replaces A, K, or E depending on the shipping destination.

■ Opening half-punched holes and mounting rubber bushes

- ① Tap the three half-punched holes of the cable guide plate by using a screwdriver grip end or the like and punch them out.

Note Be careful not to injure yourself by sharp cutting edges of parts.

- ② Set the three attached rubber bushes in the punched holes. Make cut-outs on the rubber bushes before wiring.

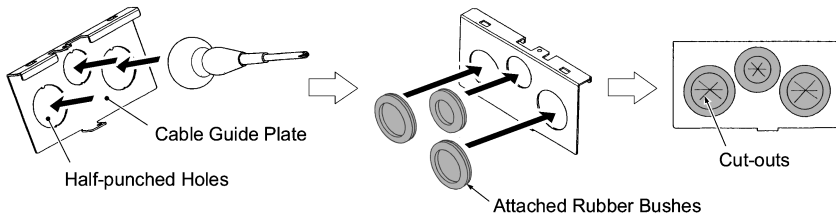

Figure 2.11 Punching out the Holes and Mounting the Rubber Bushes

⚠ WARNING

Be sure to use the rubber bushes. If not, a sharp cutting edge of the cable guide plate hole may damage the cable sheath. This may induce a short-circuit fault or ground fault.

A fire or an accident may be caused.

■ Mounting the cable guide plate

Mount the cable guide plate following the steps illustrated in Figure 2.10 in reverse. (Tightening torque: 1.8 N·m)

2.3.3 Terminal arrangement diagram and screw specifications

The table below shows the main circuit screw sizes, tightening torque and terminal arrangements. Note that the terminal arrangements differ according to the inverter types. Two terminals designed for grounding shown as the symbol,  in Figures A to J make no distinction between a power supply source (a primary circuit) and a motor (a secondary circuit).

(1) Arrangement of the main circuit terminals

Table 2.6 Main Circuit Terminal Properties

Power supply voltage	Nominal applied motor (kW)	Inverter type	Terminal screw size	Tightening torque (N·m)	Grounding screw size	Tightening torque (N·m)	Refer to:					
Three-phase 200 V	0.75	FRN0.75F1S-2□	M4	1.8	M4	1.8	Figure A					
	1.5	FRN1.5F1S-2□										
	2.2	FRN2.2F1S-2□										
	3.7	FRN3.7F1S-2□										
	5.5	FRN5.5F1S-2□										
	7.5	FRN7.5F1S-2□	M5	3.8	M5	3.8	Figure B					
	11	FRN11F1S-2□										
	15	FRN15F1S-2□	M6	5.8	M6	5.8	Figure C					
	18.5	FRN18.5F1S-2□										
	22	FRN22F1S-2□										
	Three-phase 400 V	30	FRN30F1S-2□	M8	13.5	M8	13.5	Figure D				
		37	FRN37F1S-2□	M10	27			Figure E				
		45	FRN45F1S-2□									
55		FRN55F1S-2□										
75		FRN75F1S-2□	M4	1.8	M4			1.8	Figure A			
0.75		FRN0.75F1S-4□										
1.5		FRN1.5F1S-4□										
2.2		FRN2.2F1S-4□										
3.7		FRN3.7F1S-4□										
(4.0)*		FRN4.0F1S-4E										
5.5		FRN5.5F1S-4□										
7.5		FRN7.5F1S-4□				M5	3.8			M5	3.8	Figure B
11		FRN11F1S-4□										
15	FRN15F1S-4□	M6				5.8	M6			5.8	Figure C	
18.5	FRN18.5F1S-4□											
22	FRN22F1S-4□											
30	FRN30F1S-4□	M8				13.5	M8			13.5	Figure D	
37	FRN37F1S-4□											
45	FRN45F1S-4□											
55	FRN55F1S-4□											
75	FRN75F1S-4□											
90	FRN90F1S-4□	M10	27	M10	27	Figure G						
110	FRN110F1S-4□											
132	FRN132F1S-4□											
160	FRN160F1S-4□	M12	48	M10	27	Figure H						
200	FRN200F1S-4□											
220	FRN220F1S-4□											

Terminal R0, T0 (Common to all types): Screw size M3.5, Tightening torque 1.2 (N·m)

Terminal R1, T1: Screw size M3.5, Tightening torque 0.9 (N·m) (for the models of 200 V series 45 kW or above, for 400 V series 55 kW or above)

* The applicable motor rating of FRN4.0F1S-4E to be shipped for EU is 4.0 kW.

Note: A box (□) in the above table replaces A, K, or E depending on the shipping destination.

Figure A

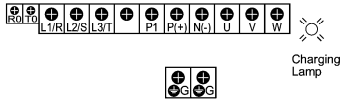

Figure B

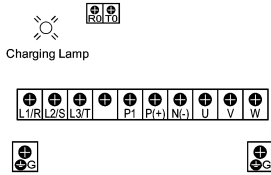

Figure C

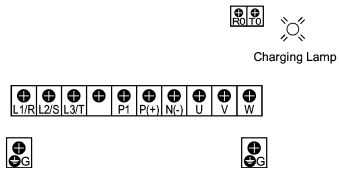

Figure D

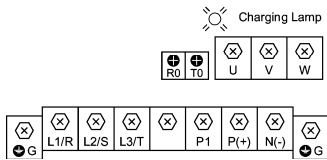

Figure E

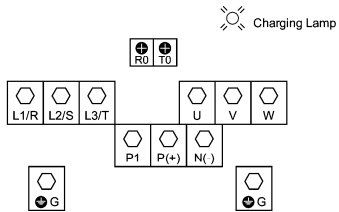

Figure F

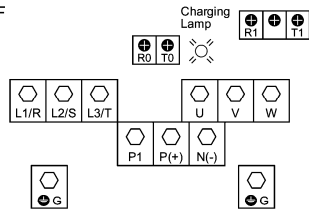

Figure G

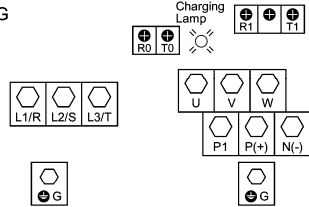

Figure H

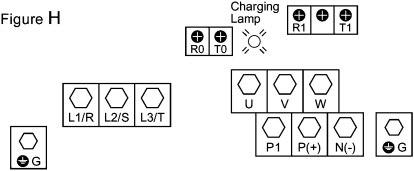

Figure I

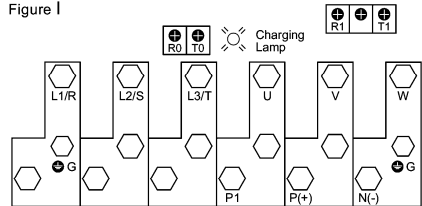
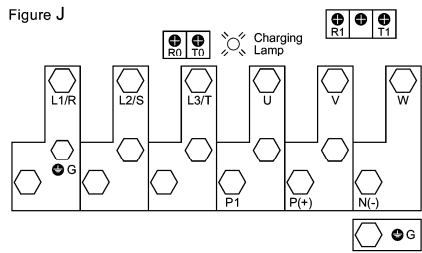
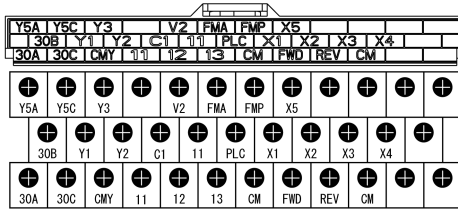

Figure J



(2) The control circuit terminals (common to all models)

- For the screw terminal base



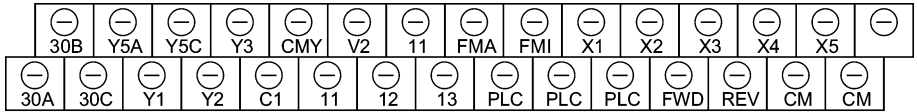

Screw size: M3 Tightening torque: 0.7 (N·m)

- For the Europe type terminal block



Screw size: M3 Tightening torque: 0.5 to 0.6 (N·m)

Table 2.7 Control Circuit Terminals

Screwdriver to be used (Head style)	Allowable wire size	Bared wire length 	Dimension of openings in the control circuit terminals for Europe type terminals* 
Flat head (0.6 x 3.5 mm)	AWG26 to AWG16 (0.14 to 1.5 mm ²)	7 mm	2.75 (W) x 2.86 (H) mm

* Manufacturer of Europe type terminals: Phoenix Contact Inc. Refer to Table 2.8.

Table 2.8 Recommended Europe Type Terminals

Screw size	Type	
	With insulated collar	Without insulated collar
AWG24 (0.25 mm ²)	AI0.25-6BU	-
AWG22 (0.34 mm ²)	AI0.34-6TQ	A0.34-7
AWG20 (0.5 mm ²)	AI0.5-6WH	A0.5-6
AWG18 (0.75 mm ²)	AI0.75-6GY	A0.75-6
AWG16 (1.25 mm ²)	AI1.5-6BK	A1.5-7

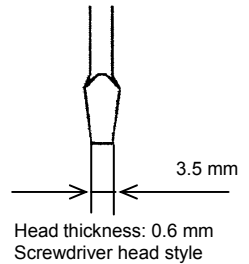

2.3.4 Recommended wire sizes

Table 2.9 lists the recommended wire sizes. Those for main circuits are examples for using a single wire (for 60/70°C) at an ambient temperature of 50°C.

Table 2.9 Recommended Wire Sizes

Power supply voltage	Nominal applied motor (kW)	Inverter type	Recommended wire size (mm ²) *1							Control circuit	
			Main circuits					DCR [P1, P (+)]	Control circuit		
			Main circuit power input (L1/R, L2/S, L3/T)		Grounding [EG]	Inverter output [U, V, W]	Auxiliary Power Input (Ctrl. cct.) [R0, T0]				Auxiliary Power Input (Fans) [R1, T1]
			w/ DCR	w/o DCR							
Three-phase 200 V	0.75	FRN0.75F1S-2□	2	2	2	2	2	-	2	0.75 to 1.25	
	1.5	FRN1.5F1S-2□									
	2.2	FRN2.2F1S-2□									
	3.7	FRN3.7F1S-2□									
	5.5	FRN5.5F1S-2□									3.5
	7.5	FRN7.5F1S-2□	3.5	5.5	5.5	3.5					
	11	FRN11F1S-2□	5.5	14		8					
	15	FRN15F1S-2□	14	22	8	14	2	-	14		
	18.5	FRN18.5F1S-2□							22		
	22	FRN22F1S-2□							22		38
	30	FRN30F1S-2□	38	60	14	38	2	-	38		
	37	FRN37F1S-2□							60		
	45	FRN45F1S-2□	60	100	22	60	2	-	100		
55	FRN55F1S-2□	100									
75	FRN75F1S-2□	60x2 or 150 *2	-	-	100	-	-	150			
Three-phase 400 V	0.75	FRN0.75F1S-4□	2	2	2	2	2	-	2	0.75 to 1.25	
	1.5	FRN1.5F1S-4□									
	2.2	FRN2.2F1S-4□									
	3.7 (4.0)*3	FRN3.7F1S-4□ FRN4.0F1S-4E									
	5.5	FRN5.5F1S-4□									
	7.5	FRN7.5F1S-4□									
	11	FRN11F1S-4□									3.5
	15	FRN15F1S-4□	3.5	5.5	3.5						
	18.5	FRN18.5F1S-4□	5.5	8	5.5	5.5	2	-	5.5		
	22	FRN22F1S-4□							14		
	30	FRN30F1S-4□	14	22	8	14	2	-	14		
	37	FRN37F1S-4□							22		
	45	FRN45F1S-4□							22		38
	55	FRN55F1S-4□	22	38	14	38	2	-	38		
	75	FRN75F1S-4□							60		
	90	FRN90F1S-4□							100		
	110	FRN110F1S-4□							150		
132	FRN132F1S-4□	150	200	22	150	2	-	150			
160	FRN160F1S-4□							200			
200	FRN200F1S-4□							38			
220	FRN220F1S-4□	200	-	-	200	-	-	250			

DCR: DC reactor

*1 Use the terminal crimp with an insulation sheath or with processing by the insulation tube.

Use the insulated wire with allowable heat resistance to 60 or 70°C. This selection assumes the inverter is used in ambient temperature at 50°C.

*2 When using the 150 mm² wire in size, apply the CB150-10 crimp terminal for low voltage appliance in compliance with JEM1399 or its equivalent.

*3 The applicable motor rating of FRN4.0F1S-4E to be shipped for EU is 4.0 kW.

Note: A box (□) in the above table replaces A, K, or E depending on the shipping destination.

2.3.5 Wiring precautions

Follow the rules below when performing wiring for the inverter.

- (1) Make sure that the source voltage is within the rated voltage range specified on the nameplate.
- (2) Be sure to connect the three-phase power wires to the main circuit power input terminals L1/R, L2/S and L3/T of the inverter. If the power wires are connected to other terminals, the inverter will be damaged when the power is turned on.
- (3) Always connect the grounding terminal to prevent electric shock, fire or other disasters and to reduce electric noise.
- (4) Use crimp terminals covered with insulated sleeves for the main circuit terminal wiring to ensure a reliable connection.
- (5) Keep the power supply wiring (primary circuit) and motor wiring (secondary circuit) of the main circuit, and control circuit wiring as far away as possible from each other.

 WARNING	
<ul style="list-style-type: none"> • When wiring the inverter to the power source, insert a recommended molded case circuit breaker (MCCB) or earth leakage circuit breaker (ELCB) (with overcurrent protection) in the path of each pair of power lines to inverters. Use the devices recommended ones within the related current range. • Use wires in the specified size. • Tighten terminals with specified torque. Otherwise, fire could occur. • Do not connect a surge killer to the inverter's output circuit. • Do not use one multicore cable in order to connect several inverters with motors. Doing so could cause fire. • Ground the inverter in compliance with the national or local electric code. Otherwise, electric shock or fire could occur. • Qualified electricians should carry out wiring. • Be sure to perform wiring after turning the power off. Otherwise, electric shock could occur. • Be sure to perform wiring after installing the inverter. Otherwise, electric shock or injuries could occur. • Ensure that the number of input phases and the rated voltage of the product match the number of phases and the voltage of the AC power supply to which the product is to be connected. • Do not connect the power source wires to output terminals (U, V, and W). Doing so could cause fire or an accident. 	

2.3.6 Wiring for main circuit terminals and grounding terminals

Table 2.10 shows the main circuit power terminals and grounding terminals.

Table 2.10 Symbols, Names and Functions of the Main Circuit Power Terminals

Symbol	Name	Functions
L1/R, L2/S, L3/T	Main circuit power inputs	Connect the 3-phase input power lines.
U, V, W	Inverter outputs	Connect a 3-phase motor.
R0, T0	Auxiliary power input for the control circuit	For a backup of the control circuit power supply, connect AC power lines same as that of the main power input.
P1, P(+)	DC reactor connection	Connect a DC reactor (DCR) for improving power factor (an option for the inverter whose capacity is 55 kW or below).
P(+), N(-)	DC link bus	Connect a DC link bus of other inverter(s). An optional regenerative converter is also connectable to these terminals.
R1, T1	Auxiliary power input for the fans	Normally, no need to use these terminals. Use these terminals for an auxiliary power input of the fans in a power system using a power regenerative PWM converter (RHC series).
	Grounding for inverter and motor	Grounding terminals for the inverter's chassis (or case) and motor. Earth one of the terminals and connect the grounding terminal of the motor. Inverters provide a pair of grounding terminals that function equivalently.

Follow the procedure below for wiring and configuration of the inverter. Figure 2.12 illustrates the wiring procedure with peripheral equipment.

Wiring procedure

- ① Grounding terminals (G)
- ② Inverter output terminals (U, V, W, and G)
- ③ DC reactor connection terminals (P1 and P(+))*
- ④ Switching connectors* (For the models of 200 V series 45 kW or above, for 400 V series 55 kW or above. Refer to page 2-18.)
- ⑤ DC link bus terminals (P(+) and N(-))*
- ⑥ Main circuit power input terminals (L1/R, L2/S and L3/T)
- ⑦ Auxiliary power input terminals for the control circuit (R0 and T0)*
- ⑧ Auxiliary power input terminals for the fans (R1 and T1)* (For models of 200 V series 45 kW or above, for 400 V series 55 kW or above. Refer to page 2-22.)

* Perform wiring as necessary

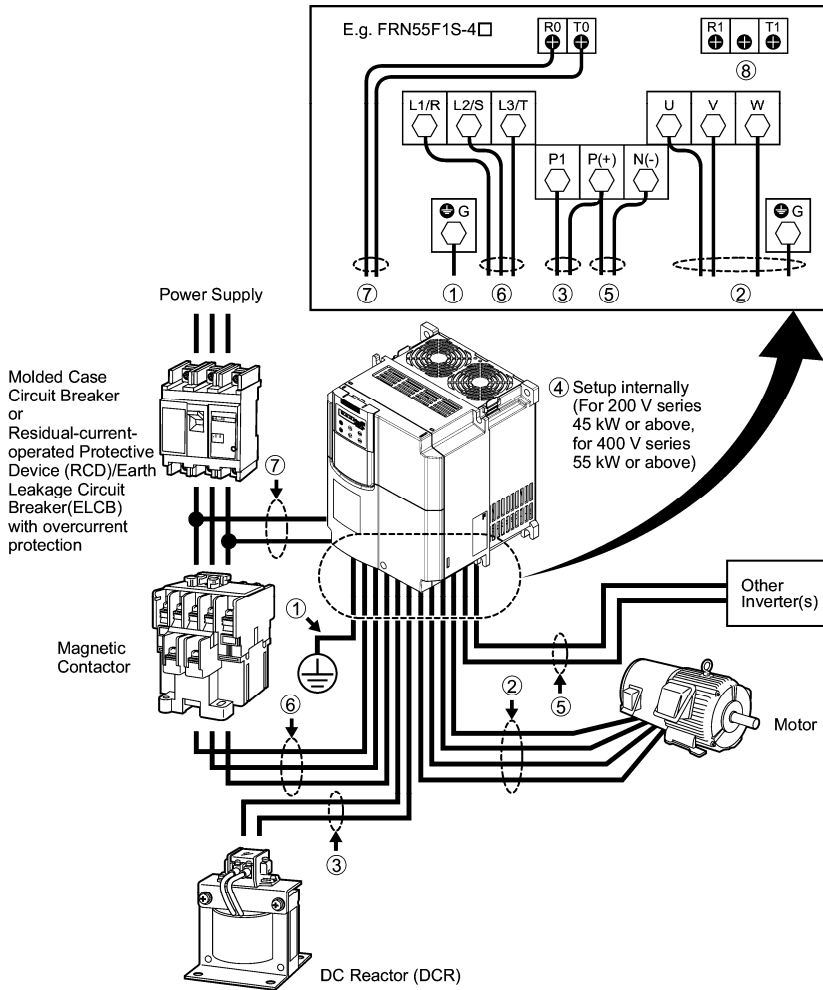

Note: A box (□) in the above figure replaces A, K, or E depending on the shipping destination.

Figure 2.12 Wiring Procedure for Peripheral Equipment

① Grounding terminals (⚡G)

Be sure to ground either of the two grounding terminals for safety and noise reduction. The inverter is designed to use with a safety grounding to avoid electric shock, fire and other disasters.

Grounding terminals should be grounded as follows:

- 1) Ground the inverter in compliance with the national or local electric code.
- 2) Use a thick grounding wire with a large surface area and keep the wiring length as short as possible.

② Inverter output terminals, U, V, W and grounding terminals (⚡G)

Inverter's output terminals should be connected as follows:

- 1) Connect the three wires of the 3-phase motor to terminals U, V, and W, aligning phases each other.
- 2) Connect the secondary grounding wire to the grounding terminal (⚡G).

- Note**
- The wiring length between the inverter and motor should not exceed 50 m, when they are connected directly. If the wiring length exceeds 50 m, an output circuit filter (option) should be inserted. (E.g. total power cable length is 400 m as shown in the figure below.)
 - Do not use one multicore cable to connect several inverters with motors even if some possible combinations of inverters and motors are considered.

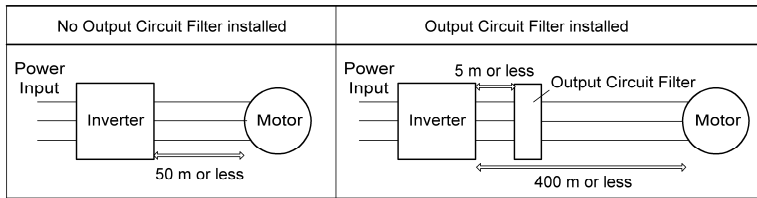

- Note**
- Do not connect a power factor correcting capacitor or surge absorber to the inverter's output lines (secondary circuit).
 - If the wiring length is long, the stray capacitance between the wires will increase, resulting in an outflow of the leakage current. It will activate the overcurrent protection, increase the leakage current, or will not assure the accuracy of the current display. In the worst case, the inverter could be damaged.
 - If more than one motor is to be connected to a single inverter, the wiring length should be the sum of the length of the wires to the motors.
 - If an output circuit filter is installed in the inverter or the wires between the motor and the inverter are too long, the actual voltage applied to the motor would drop measurably because of the voltage drop over the filter or the wires. As a result, the output current may fluctuate because of an insufficient voltage.
In such installations, set the voltage on the higher side, by setting the function code F37 (Load Selection/Auto torque Boost/Auto energy Saving Operation) to "1: Variable torque load increasing in proportion to square of speed" (Higher start-up torque required), or selecting a non-linear V/f pattern (using the function codes H50 and H51 (Non-linear V/f pattern (Frequency and Voltage))).
 - Use an output circuit (secondary) filter of OFL-□□□□-□A.

Note Driving 400 V series motor

- If a thermal relay is installed in the path between the inverter and the motor to protect the motor from overheating, the thermal relay may malfunction even with a wiring length shorter than 50 m. In this situation, add an output circuit filter (option) or lower the carrier frequency (Function code F26).
- If the motor is driven by a PWM-type inverter, surge voltage that is generated by switching the inverter component may be superimposed on the output voltage and may be applied to the motor terminals. Particularly if the wiring length is long, the surge voltage may deteriorate the insulation resistance of the motor. Consider any of the following measures.
 - Use a motor with insulation that withstands the surge voltage. (All Fuji standard motors feature insulation that withstands the surge voltage.)
 - Connect an output circuit filter (option) to the output terminals (secondary circuits) of the inverter.
 - Minimize the wiring length between the inverter and motor (10 to 20 m or less).

③ DC reactor terminals, P1 and P (+)

- 1) Remove the jumper bar from terminals P1 and P(+).
- 2) Connect a DC reactor (option) to terminals P1 and P(+).

Note

- The wiring length should be 10 m or below.
- Do not remove the jumper bar if a DC reactor is not going to be used.
- An inverter with a capacity of 75 kW or above is equipped with a DC reactor as standard. Be sure to connect the DC reactor except when an optional converter is connected to the inverter.

④ Switching connectors

- Power switching connectors (CN UX) (for the models of 400 V series 55 kW or above)

An inverter of 400 V series 55 kW or above is equipped with a set of switching connectors CU UX (male) which should be configured with a jumper according to the power source voltage and frequency. Set the jumper to U1 or U2 depending upon the power source voltage applied to the main power inputs (L1/R, L2/S, L3/T) or auxiliary power input terminals (R1, T1) for fans, as shown in Figure 2.16.

- Fan power supply switching connectors (CN R) and (CN W) (for models of 45 kW or above (200 V series) or 55 kW or above (400 V series))

The standard FRENIC-Eco series of inverters also accept DC-linked power input in combination with a power regenerative PWM converter (RHC series). Even when you drive the inverter with a DC-linked power, however, you also need to supply AC power for models of 45 kW or above (200 V series) or 55 kW or above (400 V series), since it contains components such as AC fans that are driven by AC power. In this case, reinstall the connectors (CN R) and (CN W) to the **[NC]** and **[FAN]** positions respectively and supply the power to the auxiliary power input terminals (R1, T1).

For the actual procedure, refer to Figures 2.14 to 2.16 below.

Note On the fan power supply switching connectors (CN R) and (CN W), the jumpers are installed at **[FAN]** and **[NC]** positions respectively by factory default. Do not relocate the jumper unless you drive the inverter with a DC-linked power supply.

If there is a mistake in the installation of the jumpers for the switching connectors, the cooling fan will not run, causing a heat sink overheating alarm "H1" or a charger circuit error alarm "PbF".

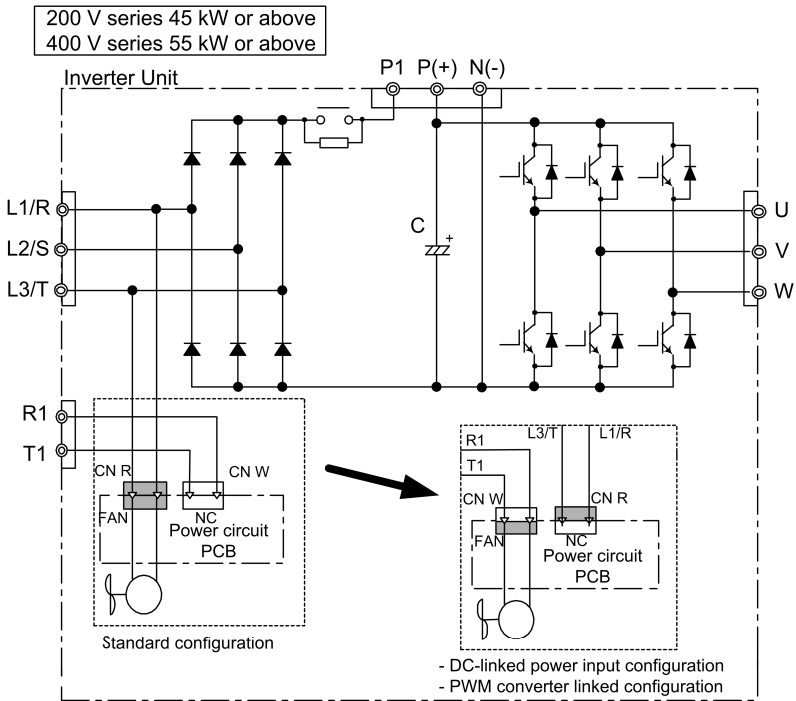

Figure 2.13 Switching Fan Power Source

■ Setting up the jumpers for the connectors (CN UX), (CN R) and (CN W)

These switching connectors are located on the power printed circuit board (power PCB) mounted at the right hand side of the control printed circuit board (control PCB) as shown below.

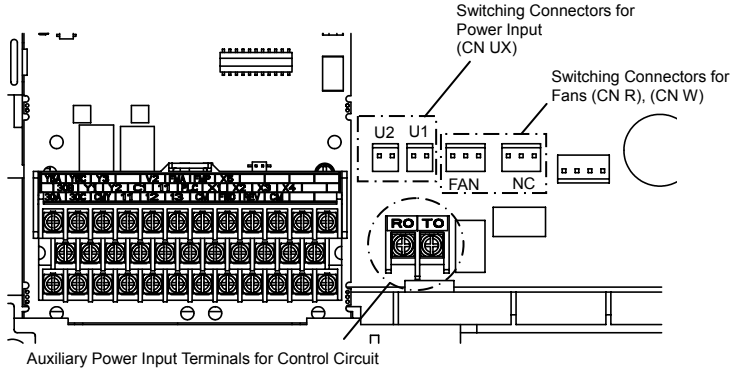

Figure 2.14 Location of Switching Connectors and Auxiliary Power Input Terminals

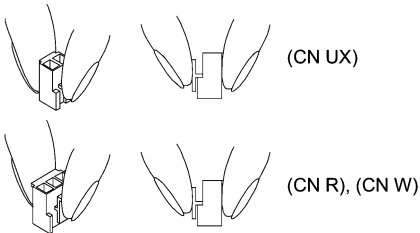

Figure 2.15 Inserting/Removing the Jumpers

Note To remove the jumper, pinch its upper side between your fingers, unlock its fastener and pull it up. To insert it, pull it down as firmly as it locks with the connector until you will have heard a click sound.

Figure 2.16 shown below illustrates how the configuration jumpers of the connectors (CN UX), (CN R) and (CN W) are setup by factory defaults, and to change their settings for a new power configuration.

- Setting up the power switching connector (CN UX)
(for the models of 400 V series 55 kW or above)

The connector configuration of the factory default is "U1" for Asia/Taiwan/Korea/EU.

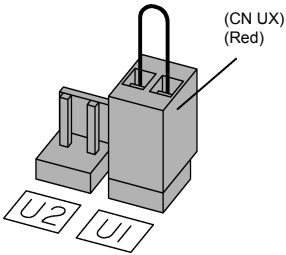
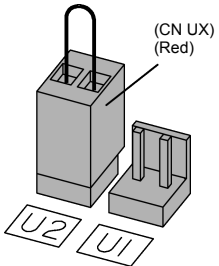
Connector configuration		
Power source voltage	<p>398 to 440 V/50 Hz 430 to 480 V/60 Hz (Factory default for Asia/Taiwan/Korea/EU)</p> <p>Note: Allowable power input voltage range should be within - 15% to +10% of power source voltage.</p>	<p>380 to 398 V/50 Hz 380 to 430 V/60 Hz</p> <p>Note: Allowable power input voltage range should be within - 15% to +10% of power source voltage.</p>

- Setting up the fan power supply switching connectors (CN R) and (CN W)
(for the models of 200 V series 45 kW or above ; 400 V series 55 kW or above)



Connector configuration		
Power system operation	<p>When using no terminal R1, T1 (Factory default)</p>	<p>When using the terminals R1, T1</p> <ul style="list-style-type: none"> • Feeding the DC-linked power • Combined with a PWM converter

Figure 2.16 Reconfiguration of the (CN UX), (CN R) and (CN W) Connectors

⑤ DC link bus terminals, P (+) and N (-)

These are provided for the DC link bus powered system. Connect these terminals with terminals P(+) and N (-) of other inverters.

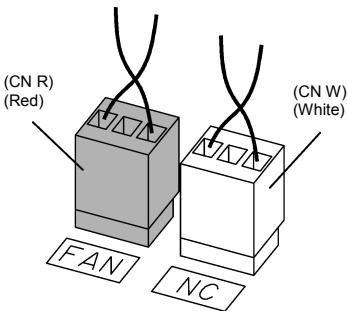
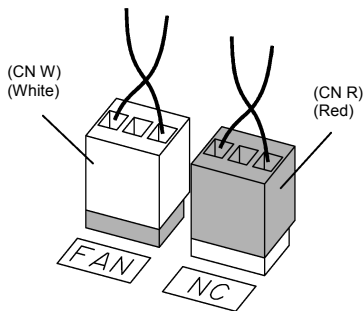
 **Note** Consult your Fuji Electric representative if these terminals are to be used.

⑥ Main circuit power input terminals, L1/R, L2/S, and L3/T (three-phase input)

- 1) For safety, make sure that the molded case circuit breaker (MCCB) or magnetic contactor (MC) is turned off before wiring the main circuit power input terminals.
- 2) Connect the main circuit power supply wires (L1/R, L2/S and L3/T) to the input terminals of the inverter via an MCCB or residual-current-operated protective device (RCD)/earth leakage circuit breaker (ELCB)*, and MC if necessary.

It is not necessary to align phases of the power supply wires and the input terminals of the inverter with each other.

* With overcurrent protection

 **Tip** It is recommended that a magnetic contactor be inserted that can be manually activated. This is to allow you to disconnect the inverter from the power supply in an emergency (e.g., when the protective function is activated) so as to prevent a failure or accident from causing the secondary problems.

⑦ Auxiliary power input terminals R0 and T0 for the control circuit

In general, the inverter will run normally without power supplied to the auxiliary power input for the control circuit. However, if you share the input power for the control circuit with that for the main circuit, you would be lost when, in the event of an error or alarm, you turn OFF the magnetic contactor between the inverter and the commercial power supply. If the magnetic contactor is turned OFF, the input power to the control circuit is shut OFF, causing the alarm signals (30A/B/C) to be lost and the display on the keypad to disappear. To secure input power to the control circuit at all times, supply the power from the primary side of the magnetic contactor to control power auxiliary input terminals R0 and T0.

⑧ Auxiliary power input terminals R1 and T1 for the fan

Inverters, 200 V series 45 kW or above and 400 V series 55 kW or above are equipped with these terminals R1 and T1. Only if the inverter works with the DC linked power input whose source is a power regenerative PWM converter (e.g. RHC series), these terminals are used to feed power to the fans while they are not used in any power system of ordinary configuration. The fan power is:

Single phase 200 to 220 VAC/50 Hz, 200 to 230 VAC/60 Hz for 200 V series 45 kW or above
Single phase 380 to 440 VAC/50 Hz, 380 to 480 VAC/60 Hz for 400 V series 55 kW or above

2.3.7 Wiring for control circuit terminals

WARNING

In general, sheaths and covers of the control signal cables and wires are not specifically designed to withstand a high electric field (i.e., reinforced insulation is not applied). Therefore, if a control signal cable or wire comes into direct contact with a live conductor of the main circuit, the insulation of the sheath or the cover might break down, which would expose the signal wire to a high voltage of the main circuit. Make sure that the control signal cables and wires will not come into contact with live conductors of the main circuit.

Failure to observe these precautions could cause electric shock and/or an accident.

CAUTION

Noise may be emitted from the inverter, motor and wires.

Take appropriate measure to prevent the nearby sensors and devices from malfunctioning due to such noise.

An accident could occur.

Table 2.11 lists the symbols, names and functions of the control circuit terminals. The wiring to the control circuit terminals differs depending upon the setting of the function codes, which reflects the use of the inverter. Route wires properly to reduce the influence of noise, referring to the notes on the following pages.

Table 2.11 Symbols, Names and Functions of the Control Circuit Terminals

Classification	Symbol	Name	Functions
Analog input	[13]	Potentiometer power supply	Power supply (+10 VDC) for the potentiometer that gives the frequency command (Potentiometer: 1 to 5kΩ) Allowable output current: 10 mA
	[12]	Voltage input	(1) The frequency is commanded according to the external analog input voltage. 0 to 10 VDC/0 to 100 (%) (Normal mode operation) 10 to 0 VDC/0 to 100 (%) (Inverse mode operation) (2) Used for PID process command signal or its feedback. (3) Used as an additional auxiliary frequency command to be added to one of various main frequency commands. * Input impedance: 22kΩ * The allowable maximum input voltage is +15 VDC. If the input voltage is +10 VDC or more, the inverter will interpret it as +10 VDC.
	[C1]	Current input	(1) The frequency is commanded according to the external analog input current. 4 to 20 mA DC/0 to 100 (%) (Normal mode operation) 20 to 4 mA DC/0 to 100 (%) (Inverse mode operation) (2) Used for PID process command signal or its feedback. (3) Used as an additional auxiliary frequency command to be added to one of various main frequency commands. * Input impedance: 250Ω * The allowable input current is +30 mA DC. If the input current exceeds +20 mA DC, the inverter will interpret it as +20 mA DC.
	[V2]	Voltage input	(1) The frequency is commanded according to the external analog input voltage. 0 to 10 VDC/0 to 100 (%) (Normal mode operation) 10 to 0 VDC/0 to 100 (%) (Inverse mode operation) (2) Used for PID process command signal or its feedback. (3) Used as an additional auxiliary frequency command to be added to one of various main frequency commands. * Input impedance: 22kΩ * The allowable input voltage is +15 VDC. If the input voltage exceeds +10 VDC, however, the inverter will interpret it as +10 VDC. (4) Connects PTC (Positive Temperature Coefficient) thermistor for motor protection. Ensure that the slide switch SW5 on the control PCB is turned to the PTC position (refer to Section 2.3.8 "Setting up slide switches and handling control circuit terminal symbol plate." The figure shown at the right illustrates the internal circuit diagram where SW5 (switching the input of terminal [V2] between V2 and PTC) is turned to the PTC position. For details on SW5, refer to Section 2.3.8 "Setting up slide switches and handling control circuit terminal symbol plate." In this case, you must change data of the function code H26.
	[11]	Analog common	Two common terminals for analog input and output signal terminals [13], [12], [C1], [V2] and [FMA]. These terminal are electrically isolated from terminals [CM]s and [CMY].

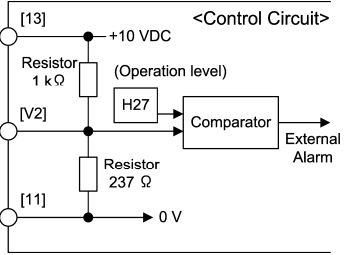

Figure 2.17 Internal Circuit Diagram (SW5 Selecting PTC)

Classification	Symbol	Name	Functions
Analog input	<p>Note</p>		<ul style="list-style-type: none"> - Since low level analog signals are handled, these signals are especially susceptible to the external noise effects. Route the wiring as short as possible (within 20 m) and use shielded wires. In principle, ground the shielded sheath of wires; if effects of external inductive noises are considerable, connection to terminal [11] may be effective. As shown in Figure 2.18, ground the single end of the shield to enhance the shielding effect. - Use a twin contact relay for low level signals if the relay is used in the control circuit. Do not connect the relay's contact to terminal [11]. - When the inverter is connected to an external device outputting the analog signal, a malfunction may be caused by electric noise generated by the inverter. If this happens, according to the circumstances, connect a ferrite core (a toroidal core or an equivalent) to the device outputting the analog signal and/or connect a capacitor having the good cut-off characteristics for high frequency between control signal wires as shown in Figure 2.19. - Do not apply a voltage of +7.5 VDC or higher to terminal [C1]. Doing so could damage the internal control circuit.
Figure 2.18 Connection of Shielded Wire	Figure 2.19 Example of Electric Noise Reduction		

Table 2.11 Continued

Classification	Symbol	Name	Functions																										
Digital input	[X1]	Digital input 1	(1) The various signals such as coast-to-stop, alarm from external equipment, and multistep frequency commands can be assigned to terminals [X1] to [X5], [FWD] and [REV] by setting function codes E01 to E05, E98, and E99. For details, refer to Chapter 5, Section 5.2 "Overview of Function Codes." (2) Input mode, i.e. Sink/Source, is changeable by using the internal slide switch. (3) Switches the logic value (1/0) for ON/OFF of the terminals between [X1] to [X5], [FWD] or [REV], and [CM]. If the logic value for ON between [X1] and [CM] is 1 in the normal logic system, for example, OFF is 1 in the negative logic system and vice versa. (4) The negative logic system never applies to the terminals assigned for (FWD) and (REV).																										
	[X2]	Digital input 2																											
	[X3]	Digital input 3																											
	[X4]	Digital input 4																											
	[X5]	Digital input 5																											
	[FWD]	Run forward command	(Digital input circuit specifications) 																										
	[REV]	Run reverse command	<table border="1"> <thead> <tr> <th>Item</th> <th></th> <th>Min.</th> <th>Max.</th> </tr> </thead> <tbody> <tr> <td rowspan="2">Operation voltage (SINK)</td> <td>ON level</td> <td>0 V</td> <td>2 V</td> </tr> <tr> <td>OFF level</td> <td>22 V</td> <td>27 V</td> </tr> <tr> <td rowspan="2">Operation voltage (SOURCE)</td> <td>ON level</td> <td>22 V</td> <td>27 V</td> </tr> <tr> <td>OFF level</td> <td>0 V</td> <td>2 V</td> </tr> <tr> <td>Operation current at ON (Input voltage is at 0V)</td> <td></td> <td>2.5 mA</td> <td>5 mA</td> </tr> <tr> <td>Allowable leakage current at OFF</td> <td></td> <td>-</td> <td>0.5 mA</td> </tr> </tbody> </table>	Item		Min.	Max.	Operation voltage (SINK)	ON level	0 V	2 V	OFF level	22 V	27 V	Operation voltage (SOURCE)	ON level	22 V	27 V	OFF level	0 V	2 V	Operation current at ON (Input voltage is at 0V)		2.5 mA	5 mA	Allowable leakage current at OFF		-	0.5 mA
	Item		Min.	Max.																									
	Operation voltage (SINK)	ON level	0 V	2 V																									
OFF level		22 V	27 V																										
Operation voltage (SOURCE)	ON level	22 V	27 V																										
	OFF level	0 V	2 V																										
Operation current at ON (Input voltage is at 0V)		2.5 mA	5 mA																										
Allowable leakage current at OFF		-	0.5 mA																										
[PLC]	PLC signal power	Connects to PLC output signal power supply. (Rated voltage: +24 VDC; Allowable range: +22 to +27 VDC) This terminal also supplies a power to the circuitry connected to the transistor output terminals [Y1] to [Y3]. Refer to "Transistor output" described later in this table for more.																											
[CM]	Digital common	Two common terminals for digital input signal terminals and output terminal [FMP] These terminals are electrically isolated from the terminals, [11]s and [CMY].																											

Figure 2.20 Digital Input Circuit

Classification	Symbol	Name	Functions
Digital input	<p>Tip</p>	<p>■ Using a relay contact to turn [X1], [X2], [X3], [X4], [X5], [FWD], or [REV] ON or OFF</p>	<p>Figure 2.21 shows two examples of a circuit that uses a relay contact to turn control signal input [X1], [X2], [X3], [X4], [X5], [FWD], or [REV] ON or OFF. In circuit (a), the slide switch SW1 has been turned to SINK, whereas in circuit (b) it has been turned to SOURCE.</p> <p>Note: To configure this kind of circuit, use a highly reliable relay (Recommended product: Fuji control relay Model HH54PW.)</p>  <p>(a) With the switch turned to SINK</p> <p>(b) With the switch turned to SOURCE</p> <p>Figure 2.21 Circuit Configuration Using a Relay Contact</p>
		<p>■ Using a programmable logic controller (PLC) to turn [X1], [X2], [X3], [X4], [X5], [FWD], or [REV] ON or OFF</p>	<p>Figure 2.22 shows two examples of a circuit that uses a programmable logic controller (PLC) to turn control signal input [X1], [X2], [X3], [X4], [X5], [FWD], or [REV] ON or OFF. In circuit (a), the switch SW1 has been turned to SINK, whereas in circuit (b) it has been turned to SOURCE.</p> <p>In circuit (a) below, short-circuiting or opening the transistor's open collector circuit in the PLC using an external power source turns ON or OFF control signal [X1], [X2], [X3], [FWD], or [REV]. When using this type of circuit, observe the following:</p> <ul style="list-style-type: none"> - Connect the + node of the external power source (which should be isolated from the PLC's power) to terminal [PLC] of the inverter. - Do not connect terminal [CM] of the inverter to the common terminal of the PLC.  <p>(a) With the switch turned to SINK</p> <p>(b) With the switch turned to SOURCE</p> <p>Figure 2.22 Circuit Configuration Using a PLC</p> <p>For details about the slide switch setting, refer to Section 2.3.8 "Setting up slide switches and handling control circuit terminal symbol plate."</p>

Table 2.11 Continued

Classification	Symbol	Name	Functions
Analog output	[FMA]	Analog monitor	<p>The monitor signal for analog DC voltage (0 to +10 V) or analog DC current (+4 to +20 mA) is output. You can select either one of the output switching the slide switch SW4 on the control PCB (Refer to Section 2.3.8.), and changing data of the function code F29. You can select one of the following signal functions with function code F31.</p> <ul style="list-style-type: none"> · Output frequency · Output torque · PID feedback value · Motor output · PID output · Output current · Load factor · DC link bus voltage · Analog output test · Output voltage · Input power · Universal AO · PID command <p>* Input impedance of the external device: Min. 5kΩ (0 to 10 VDC output) Input impedance of the external device: Max. 500Ω (4 to 20 mA DC output)</p> <p>* While the terminal is outputting 0 to 10 VDC, an output less than 0.3 V may become 0.0 V.</p> <p>* While the terminal is outputting 0 to 10 VDC, it is capable of driving up to two meters with 10 kΩ impedance. While outputting the current, to drive a meter with 500 Ω impedance max. (Adjustable range of the gain: 0 to 200%)</p>
	[FMI]*	Analog monitor	<p>The monitor signal for analog DC current (+4 to +20 mA) is output. You can select one of the following signal functions with function code F35.</p> <ul style="list-style-type: none"> · Output frequency · Output torque · PID feedback value · Motor output · PID output · Output current · Load factor · DC link bus voltage · Analog output test · Output voltage · Input power · Universal AO · PID command <p>* Input impedance of the external device: Max. 500Ω</p> <p>* It is capable of driving a meter with a maximum of 500Ω impedance. (Adjustable gain range: 0 to 200%)</p>
	[11]	Analog common	<p>Two common terminals for analog input and output signal terminals These terminals are electrically isolated from terminals [CM]s and [CMY].</p>
Pulse train output	[FMP]*	Pulse monitor	<p>You can select one of the following signal functions with function code F35.</p> <ul style="list-style-type: none"> · Output frequency · Output torque · PID feedback value · Motor output · PID output · Output current · Load factor · DC link bus voltage · Analog output test · Output voltage · Input power · Universal AO · PID command <p>* Input impedance of the external device: Min. 5kΩ</p> <p>* This output is capable of driving up to two meters with 10kΩ impedance. (Driven by the average DC voltage of the output pulse train.) (Adjustable range of the gain: 0 to 200%)</p>
	[CM]	Digital common	<p>Two common terminals for digital input signal terminals and an output terminal [FMP] These terminals are electrically isolated from other common terminals, [11]s and [CMY]. These are the shared terminals with the common terminal [CM]s of the digital inputs.</p>

* The control PCB is equipped with either a screw terminal base or Europe type terminal block, supporting [FMP] or [FMI], respectively. Note that terminals [FMP] and [FMI] cannot coexist in an inverter so that the function code, F35 shares the identical function selection for these terminals.

Classification	Symbol	Name	Functions														
Transistor output	[Y1]	Transistor output 1	<p>(1) Various signals such as inverter running, speed/freq. arrival and overload early warning can be assigned to any terminals, [Y1] to [Y3] by setting function code E20, E21 and E22. Refer to Chapter 5, Section 5.2 "Overview of Function Codes" for details.</p> <p>(2) Switches the logic value (1/0) for ON/OFF of the terminals between [Y1] to [Y3] and [CMY]. If the logic value for ON between [Y1] to [Y3] and [CMY] is 1 in the normal logic system, for example, OFF is 1 in the negative logic system and vice versa.</p>														
	[Y2]	Transistor output 2	<p>Transistor output circuit specification</p>  <table border="1" style="margin-left: auto; margin-right: auto;"> <thead> <tr> <th colspan="2">Item</th> <th>Max.</th> </tr> </thead> <tbody> <tr> <td rowspan="2">Operation voltage</td> <td>ON level</td> <td>3 V</td> </tr> <tr> <td>OFF level</td> <td>27 V</td> </tr> <tr> <td colspan="2">Maximum load current at ON</td> <td>50 mA</td> </tr> <tr> <td colspan="2">Leakage current at OFF</td> <td>0.1 mA</td> </tr> </tbody> </table> <p style="text-align: center;">Figure 2.23 Transistor Output Circuit</p>	Item		Max.	Operation voltage	ON level	3 V	OFF level	27 V	Maximum load current at ON		50 mA	Leakage current at OFF		0.1 mA
	Item		Max.														
	Operation voltage	ON level	3 V														
		OFF level	27 V														
Maximum load current at ON		50 mA															
Leakage current at OFF		0.1 mA															
[Y3]	Transistor output 3	<p>Figure 2.24 shows examples of connection between the control circuit and a PLC.</p> <p>Note</p> <ul style="list-style-type: none"> - When a transistor output drives a control relay, connect a surge-absorbing diode across relay's coil terminals. - When any equipment or device connected to the transistor output needs to be supplied with DC power, feed the power (+24 VDC; allowable range: +22 to +27 VDC, 50 mA max.) through the [PLC] terminal. Short-circuit between the terminals [CMY] and [CM] in this case. 															
[CMY]	Transistor output common	<p>Common terminal for transistor output signal terminals</p> <p>This terminal is electrically isolated from terminals, [CM]s and [11]s.</p>															
<p>Tip ■ Connecting Programmable Controller (PLC) to Terminal [Y1], [Y2] or [Y3]</p> <p>Figure 2.24 shows two examples of circuit connection between the transistor output of the inverter's control circuit and a PLC. In example (a), the input circuit of the PLC serves as a sink for the control circuit output, whereas in example (b), it serves as a source for the output.</p>			 <p style="text-align: center;">(a) PLC serving as Sink (b) PLC serving as Source</p> <p style="text-align: center;">Figure 2.24 Connecting PLC to Control Circuit</p>														

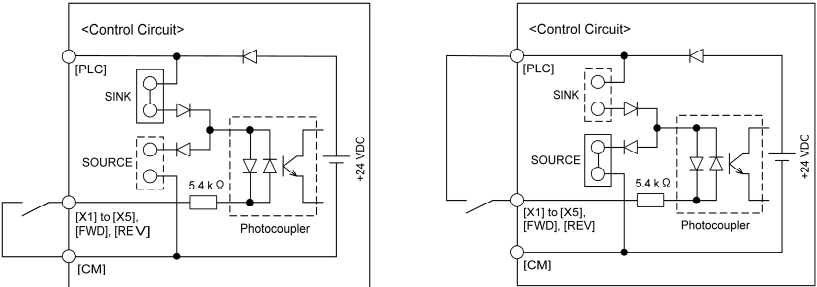
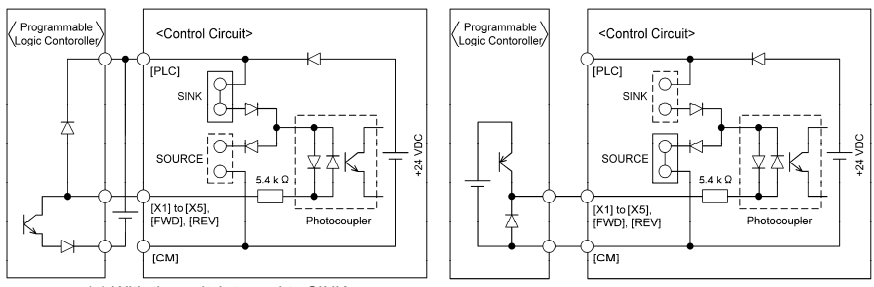
Table 2.11 Continued

Classification	Symbol	Name	Functions
Relay contact output	[Y5A/C]	General purpose relay output	<p>(1) A general-purpose relay contact output usable as well as the function of the transistor output terminal [Y1], [Y2] or [Y3]. Contact rating: <u>250 VAC 0.3 A, $\cos \phi = 0.3$</u>, <u>48 VDC, 0.5 A</u></p> <p>(2) Switching of the normal/negative logic output is applicable to the following two contact output modes: "Active ON" (Terminals [Y5A] and [Y5C] are closed (excited) if the signal is active.) and "Active OFF" (Terminals [Y5A] and [Y5C] are opened (non-excited) if the signal is active while they are normally closed.).</p>
	[30A/B/C]	Alarm relay output (for any error)	<p>(1) Outputs a contact signal (SPDT) when a protective function has been activated to stop the motor. Contact rating: <u>250 VAC, 0.3A, $\cos \phi = 0.3$</u>, <u>48 VDC, 0.5A</u></p> <p>(2) Any one of output signals assigned to terminals [Y1] to [Y3] can also be assigned to this relay contact to use it for signal output.</p> <p>(3) Switching of the normal/negative logic output is applicable to the following two contact output modes: "Terminals [30A] and [30C] are closed (excited) for ON signal output (Active ON)" or "Terminals [30B] and [30C] are closed (non-excited) for ON signal output (Active OFF)."</p>
Communication	RJ-45 connector for the keypad	Standard RJ-45 connector	<p>(1) Used to connect the inverter with PC or PLC using RS485 port. The inverter supplies the power to the keypad through the pins specified below. The extension cable for remote operation also uses wires connected to these pins for supplying the keypad power.</p> <p>(2) Remove the keypad from the standard RJ-45 connector, and connect the RS485 communications cable to control the inverter through the PC or PLC (Programmable Logic Controller). Refer to Section 2.3.8 "Setting up slide switches and handling control circuit terminal symbol plate" for setting of the terminating resistor.</p>  <p style="text-align: center;">Figure 2.25 RJ-45 Connector and its Pin Assignment*</p> <p>* Pins 1, 2, 7, and 8 are exclusively assigned to power lines for the keypad, so do not use those pins for any other equipment.</p>

Wiring for control circuit terminals

■ For models of FRN132F1S-4□ to FRN220F1S-4□*

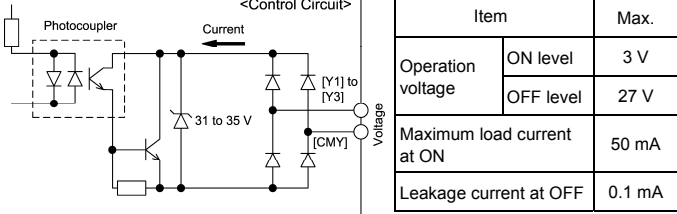
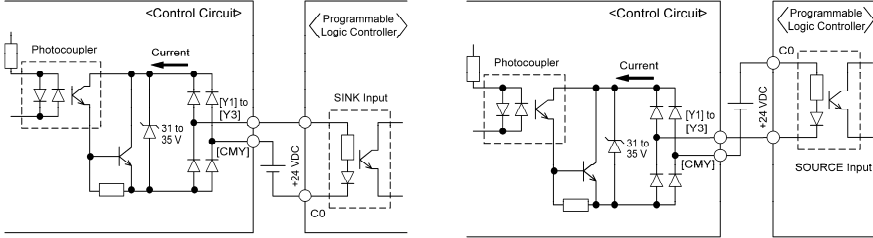
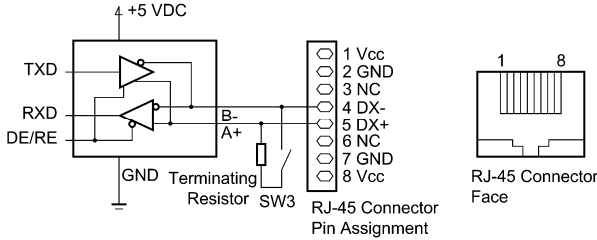
* A box (□) replaces A, K, or E depending on the shipping destination.

- ① Route the control circuit cable in keeping with the left side panel of the inverter as shown in Figure 2.26.
- ② Fasten the control circuit cable to the cable tie support with a cable tie (insulation lock) as shown in Figure 2.26.

The hole in the cable tie support is 3.8 mm × 1.5 mm in size. To pass the cable tie through the hole, it should be 3.8 mm or less in width and 1.5 mm or less in thickness.

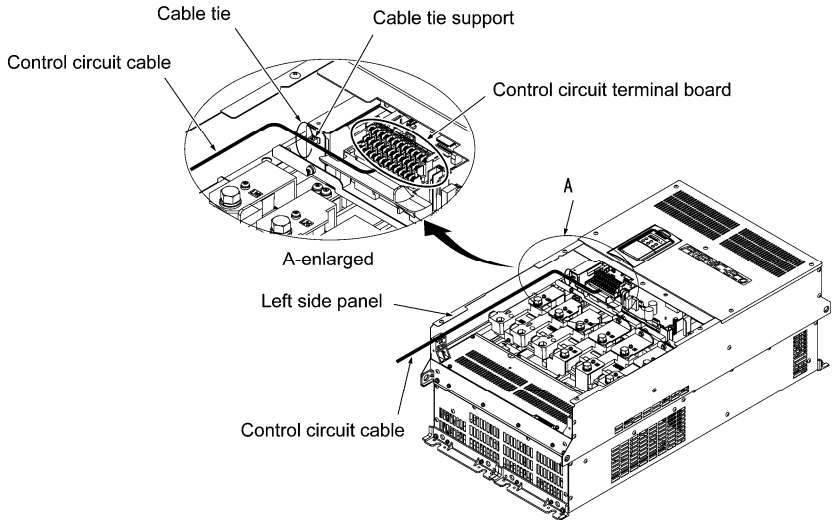

Figure 2.26 Routing and Fastening the Control Circuit Cable

- Note**
- Route the wiring of the control terminals as far from the wiring of the main circuit as possible. Otherwise electric noise may cause malfunctions.
 - Fix the control circuit wires inside the inverter to keep them away from the live parts of the main circuit (such as the terminal block of the main circuit).

2.3.8 Setting up slide switches and handling control circuit terminal symbol plate

⚠ WARNING ⚠

Before changing the switches or touching the control circuit terminal symbol plate, turn OFF the power and wait more than five minutes for models of 30 kW or below, or ten minutes for models of 37 kW or above. Make sure that the LED monitor and charging lamp (on models of 37 kW or above) are turned OFF. Further, make sure, using a multimeter or a similar instrument, that the DC link bus voltage between the terminals P (+) and N (-) has dropped below the safe voltage (+25 VDC).

An electric shock may result if this warning is not heeded as there may be some residual electric charge in the DC bus capacitor even after the power has been turned off.

■ Setting up the slide switches

Switching the slide switches located on the control PCB allows you to customize the operation mode of the analog output terminals, digital I/O terminals, and communications ports. The locations of those switches are shown in Figure 2.29.

To access the slide switches, remove the front and terminal block covers so that you can watch the control PCB. For models of 37 kW or above, open also the keypad enclosure.

For a screw terminal base, close the control circuit terminal symbol plate since the plate being opened interferes with switching of some switches. See Figures 2.27 and 2.28.

 For details on how to remove the front cover, terminal block cover, and keypad enclosure, refer to Section 2.3.1, "Removing and mounting the terminal block (TB) cover and the front cover" and Chapter 1, Section 1.2, "External View and Terminal Blocks," Figure 1.4.

Table 2.12 lists function of each slide switch.

Table 2.12 Function of Each Slide Switch

Switch	Function									
① SW1	<p>Switches the service mode of the digital input terminals between SINK and SOURCE.</p> <ul style="list-style-type: none"> To make the digital input terminal [X1] to [X5], [FWD] or [REV] serve as a current sink, turn SW1 to the SINK position. To make them serve as a current source, turn SW1 to the SOURCE position. <table border="1" style="margin-left: 20px;"> <tr> <td></td> <td>Asia</td> <td>Taiwan/Korea</td> <td>EU</td> </tr> <tr> <td>Factory default</td> <td>SINK</td> <td>SINK</td> <td>SOURCE</td> </tr> </table>		Asia	Taiwan/Korea	EU	Factory default	SINK	SINK	SOURCE	
	Asia	Taiwan/Korea	EU							
Factory default	SINK	SINK	SOURCE							
② SW3	<p>Switches the terminating resistor of RS485 communications port on the inverter on and off.</p> <ul style="list-style-type: none"> To connect a keypad to the inverter, turn SW3 to OFF. (Factory default) If the inverter is connected to the RS485 communications network as a terminating device, turn SW3 to ON. 									
③ SW4	<p>Switches the output mode of the analog output terminal [FMA] between voltage and current. When changing this switch setting, also change the data of function code F29.</p> <table border="1" style="margin-left: 20px;"> <tr> <td></td> <td>SW4</td> <td>Set data of F29 to:</td> </tr> <tr> <td>Voltage output (Factory default)</td> <td>VO</td> <td>0</td> </tr> <tr> <td>Current output</td> <td>IO</td> <td>1</td> </tr> </table>		SW4	Set data of F29 to:	Voltage output (Factory default)	VO	0	Current output	IO	1
	SW4	Set data of F29 to:								
Voltage output (Factory default)	VO	0								
Current output	IO	1								
④ SW5	<p>Switches property of the analog input terminal [V2] for V2 or PTC. When changing this switch setting, also change the data of function code H26.</p> <table border="1" style="margin-left: 20px;"> <tr> <td></td> <td>SW5</td> <td>Set data of H26 to:</td> </tr> <tr> <td>Analog frequency command in voltage (Factory default)</td> <td>V2</td> <td>0</td> </tr> <tr> <td>PTC thermistor input</td> <td>PTC</td> <td>1 or 2</td> </tr> </table>		SW5	Set data of H26 to:	Analog frequency command in voltage (Factory default)	V2	0	PTC thermistor input	PTC	1 or 2
	SW5	Set data of H26 to:								
Analog frequency command in voltage (Factory default)	V2	0								
PTC thermistor input	PTC	1 or 2								

■ Opening and closing the control circuit terminal symbol plate for the screw terminal base

The symbolic names of the control circuit terminals are marked on the control circuit terminal symbol plate provided on the top of the terminal block. The plate can be opened or closed as necessary. Follow the procedures illustrated below to open or close the plate.

• Opening the plate

Control Circuit Terminal Symbol Plate

Handle

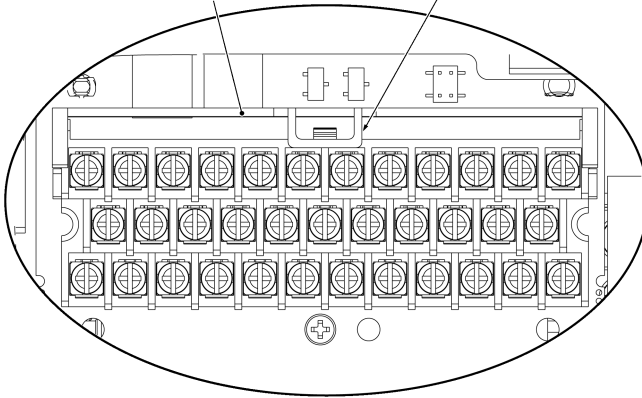

Using the handle, pull the plate toward you.
Put the plate upright.

Figure 2.27 Opening the Control Circuit Terminal Symbol Plate

• Closing the plate

Control Circuit Terminal Symbol Plate

Handle

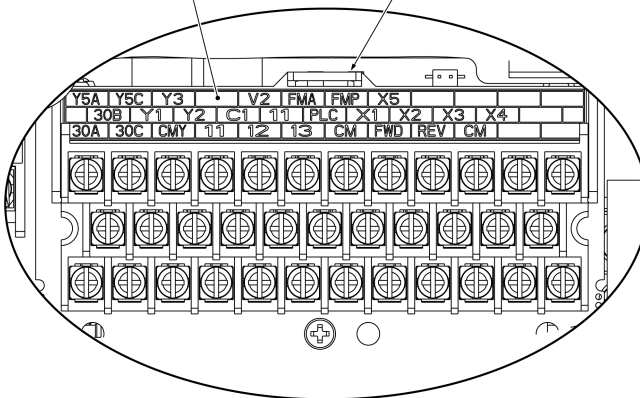

Using the handle, turn the plate down toward you and push it inward.

Figure 2.28 Closing the Control Circuit Terminal Symbol Plate

Figure 2.29 shows the location of slide switches for the input/output terminal configuration.

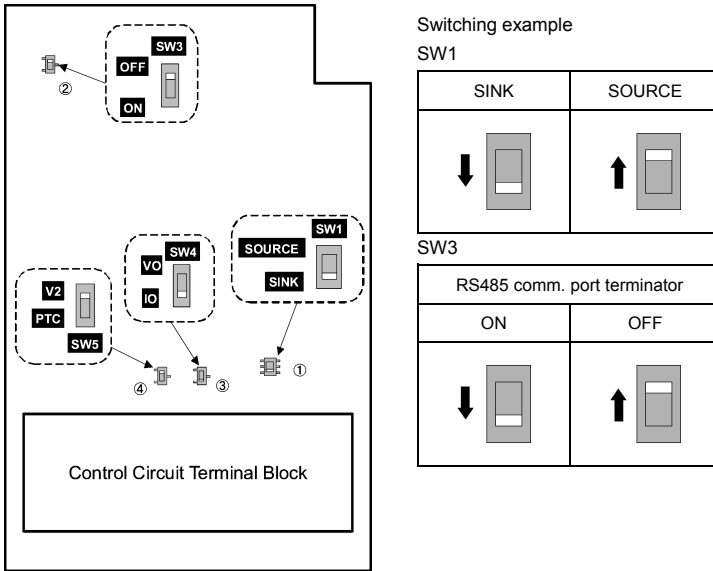

Figure 2.29 Location of the Slide Switches

2.4 Mounting and Connecting a Keypad

2.4.1 Mounting style and parts needed for connection

(1) Mounting style

You can mount a keypad in any style described below.

- Mounting a keypad on the enclosure wall (Refer to Figure 2.30.)
- Installing a keypad at a remote site (e.g. for operation on hand) (Refer to Figure 2.31.)

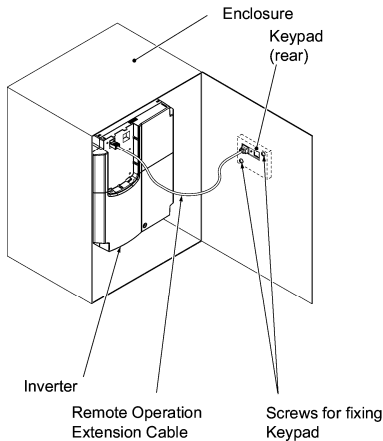

Figure 2.30 Mounting Keypad on the Enclosure Wall

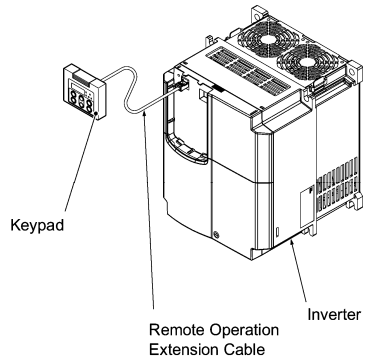

Figure 2.31 Installing Keypad at a Remote Site (e.g. for Operation on Hand)

(2) Parts needed for connection

To mount/install a keypad on a place other than an inverter, parts listed below are needed.

Parts name	Model	Remarks
Extension cable (Note 1)	CB-5S, CB-3S and CB-1S	3 cables available in length of 5m, 3m, and 1m.
Fastening screw	M3 × □ (Note 2)	Two screws needed. Purchase off-the-shelf ones separately.

(Note 1) When using an off-the-shelf LAN cable, use a 10BASE-T/100BASE-TX straight type cable compliant to US ANSI TIA/EIA-568A Category 5. (Less than 20m)

Recommended LAN cable

Manufacturer: SANWA Supply Co., LTD.

Model: KB-10T5-01K (1m)

KB-STP-01K: (1m) (Shielded LAN cable compliant to EMC Directive)

(Note 2) When mounting on an enclosure wall, use the screws fitted to the thickness of the wall. (Refer to Figure 2.34.)

2.4.2 Mounting/installing steps

■ Mounting a keypad on the enclosure wall

- ① Pull the keypad toward you while holding down the hook (pointed to by the arrow in Figure 2.32)

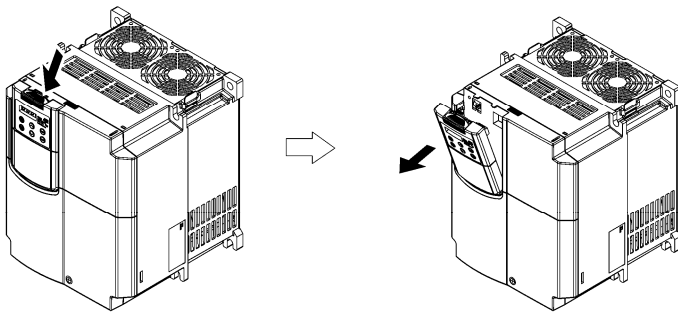

Figure 2.32 Removing a Keypad

- ② Separate the keypad from the dummy cover by sliding them in the arrowed directions as shown in Figure 2.33 below.

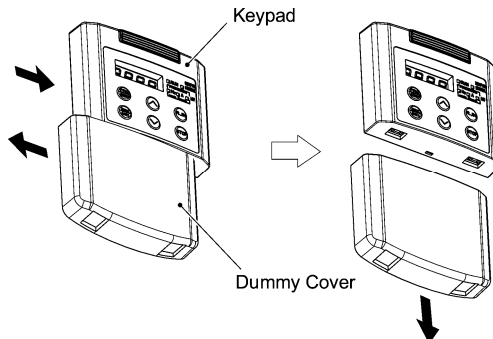

Figure 2.33 Separation of the Dummy Cover

- ③ Make a cut-out on the enclosure wall. For details, refer to Chapter 8, Section 8.5.3 “Keypad.”
- ④ To mount the keypad on the enclosure wall, fix it firmly using a pair of M3 screws put through the taps shown below. (Figure 2.34.)
(Tightening torque: 0.7N·m)

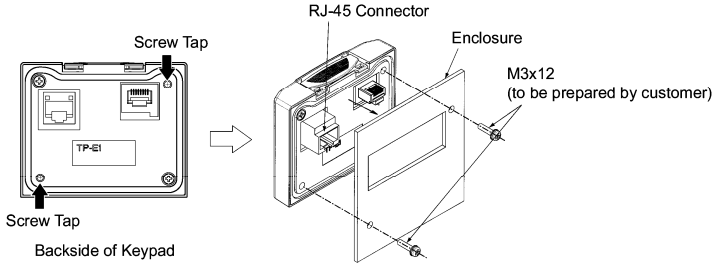

Figure 2.34 Mounting a Keypad on the Enclosure Wall

- ⑤ Connect an extension cable (CB-5S, CB-3S or CB-1S) or off-the-shelf straight LAN cable to RJ-45 connectors (Modular jacks) on the keypad and inverter (standard RS485 port.) (Refer to Figure 2.35)

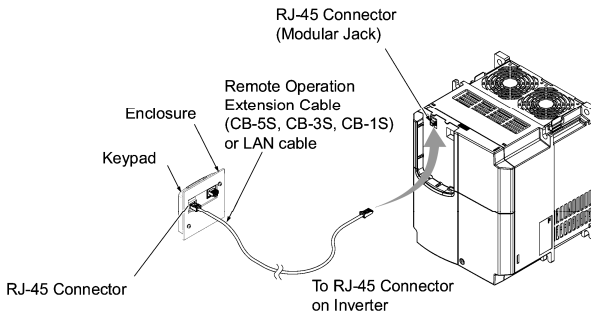

Figure 2.35 Connecting a Keypad and an Inverter's Standard RS485 port



Do not connect the inverter to a PC's LAN port, Ethernet hub or telephone line; doing so may damage the inverter or the equipment on the other end.

■ **Installing a keypad at a remote site (e.g. for operation on hand)**

Follow the step ⑤ in ■ Mounting it on the enclosure wall.

■ **Retracting the keypad into the inverter**

Put the keypad in the original slot while engaging its bottom latches with the holes (as shown below), and push it onto the case of the inverter (arrow ②) while holding it downward (against the terminal block cover) (arrow ①).

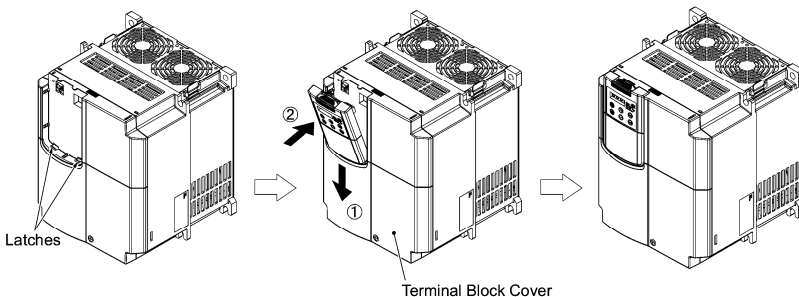

Figure 2.36 Retracting the Keypad

2.5 Cautions Relating to Harmonic Component, Noise, and Leakage Current

(1) Harmonic component

Input current to an inverter includes a harmonic component, which may affect other loads and power factor correcting capacitors that are connected to the same power source as the inverter. If the harmonic component causes any problems, connect a DC reactor (option) to the inverter. It may also be necessary to connect an AC reactor to the power factor correcting capacitors.

(2) Noise

If noise generated from the inverter affects other devices, or that generated from peripheral equipment causes the inverter to malfunction, follow the basic measures outlined below.

- 1) If noise generated from the inverter affects the other devices through power wires or grounding wires:
 - Isolate the grounded metal frames of the inverter from those of the other devices.
 - Connect a noise filter to the inverter power wires.
 - Isolate the power system of the other devices from that of the inverter with an insulated transformer.
- 2) If induction or radio noise generated from the inverter affects other devices through power wires or grounding wires:
 - Isolate the main circuit wires from the control circuit wires and other device wires.
 - Put the main circuit wires through a metal conduit and connect the pipe to the ground near the inverter.
 - Install the inverter onto the metal switchboard and connect the whole board to the ground.
 - Connect a noise filter to the inverter power wires.
- 3) When implementing measures against noise generated from peripheral equipment:
 - For the control signal wires, use twisted or shielded-twisted wires. When using shielded-twisted wires, connect the shield of the shielded wires to the common terminals of the control circuit or ground.
 - Connect a surge absorber in parallel with a coil or solenoid of the magnetic contactor.

(3) Leakage current

Harmonic component current generated by insulated gate bipolar transistors (IGBTs) switching on/off inside the inverter becomes leakage current through stray capacitors of inverter input and output wires or a motor. If any of the problems listed below occur, take an appropriate measure against them.

Table 2.13 Leakage Current Countermeasures

Problem	Measures
An earth leakage circuit breaker* that is connected to the input (primary) has tripped. * With overcurrent protection	<ol style="list-style-type: none"> 1) Decrease the carrier frequency. 2) Make the wires between the inverter and motor shorter. 3) Use an earth leakage circuit breaker that has a longer sensitive current than one currently being used. 4) Use an earth leakage circuit breaker that features measures against harmonic component (Fuji SG and EG series).
An external thermal relay was activated.	<ol style="list-style-type: none"> 1) Decrease the carrier frequency. 2) Increase the settling current of the thermal relay. 3) Use the electronic thermal relay built in the inverter, instead of an external thermal relay.

Chapter 3 OPERATION USING THE KEYPAD

3.1 LED Monitor, Keys and LED Indicators on the Keypad

As shown at the right, the keypad consists of a four-digit LED monitor, six keys, and five LED indicators.

The keypad allows you to run and stop the motor, monitor running status, and switch to the menu mode. In the menu mode, you can set the function code data, monitor I/O signal states, maintenance information, and alarm information.

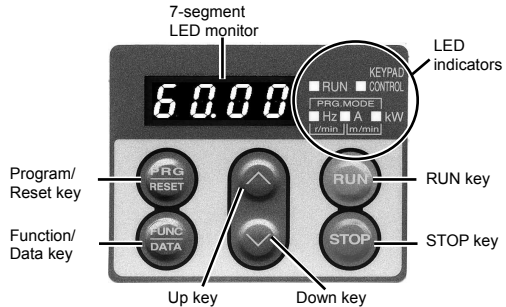

Table 3.1 Overview of Keypad Functions

Item	LED Monitor, Keys, and LED Indicators	Functions
LED Monitor		<p>Four-digit, 7-segment LED monitor which displays the following according to the operation modes.</p> <ul style="list-style-type: none"> ■ In Running mode: Running status information (e.g., output frequency, current, and voltage) ■ In Programming mode: Menus, function codes and their data ■ In Alarm mode: Alarm code, which identifies the error factor if the protective function is activated.
Operation Keys		<p>Program/Reset key which switches the operation modes of the inverter.</p> <ul style="list-style-type: none"> ■ In Running mode: Pressing this key switches the inverter to Programming mode. ■ In Programming mode: Pressing this key switches the inverter to Running mode. ■ In Alarm mode: Pressing this key after removing the error factor will switch the inverter to Running mode.
		<p>Function/Data key which switches the operation you want to do in each mode as follows:</p> <ul style="list-style-type: none"> ■ In Running mode: Pressing this key switches the information to be displayed concerning the status of the inverter (output frequency (Hz), output current (A), output voltage (V), etc.). ■ In Programming mode: Pressing this key displays the function code and sets the data entered with the / key. ■ In Alarm mode: Pressing this key displays the details of the problem indicated by the alarm code that has come up on the LED monitor.
		RUN key. Press this key to run the motor.
		STOP key. Press this key to stop the motor.
		UP and DOWN keys. Press these keys to select the setting items and change the function code data displayed on the LED monitor.
LED Indicators	RUN LED	Lights when any run command to the inverter is active.
	KEYPAD CONTROL LED	Lights when the inverter is ready to run with a run command entered by the key. In Programming and Alarm modes, you cannot run the inverter even if the indicator lights.
	Unit and mode expression by the three LED indicators	<p>The lower 3 LED indicators identify the unit of numeral displayed on the LED monitor in Running mode by combination of lit and unlit states of them. Unit: kW, A, Hz, r/min and m/min Refer to Chapter 3, Section 3.3.1 "Monitoring the running status" for details.</p> <hr/> <p>While the inverter is in Programming mode, the LEDs at both ends of the lower indicators light. In Programming mode: ■ Hz □ A ■ kW</p>

Simultaneous keying

Simultaneous keying means pressing two keys at the same time. The FRENIC-Eco supports simultaneous keying as listed below. The simultaneous keying operation is expressed by a "+" letter between the keys throughout this manual.

(For example, the expression " $\text{STOP} + \text{STOP}$ keys" stands for pressing the STOP key while holding down the STOP key.)

Table 3.2 Simultaneous Keying

Operation mode	Simultaneous keying	Used to:
Programming mode	$\text{STOP} + \text{STOP}$ keys	Change certain function code data. (Refer to codes F00, H03, and H97 in Chapter 5 "FUNCTION CODES.")
	$\text{STOP} + \text{STOP}$ keys	
Alarm mode	$\text{STOP} + \text{PRG/RESET}$ keys	Switch to Programming mode without resetting alarms currently occurred.

3.2 Overview of Operation Modes

FRENIC-Eco features the following three operation modes:

- **Running mode** : This mode allows you to enter run/stop commands in regular operation. You can also monitor the running status in real time.
- **Programming mode** : This mode allows you to set function code data and check a variety of information relating to the inverter status and maintenance.
- **Alarm mode** : If an alarm condition arises, the inverter automatically enters the Alarm mode. In this mode, you can view the corresponding alarm code* and its related information on the LED monitor.

* Alarm code: Indicates the cause of the alarm condition that has triggered a protective function. For details, refer to Chapter 8, Section 8.6 "Protective Functions."

Figure 3.1 shows the status transition of the inverter between these three operation modes.

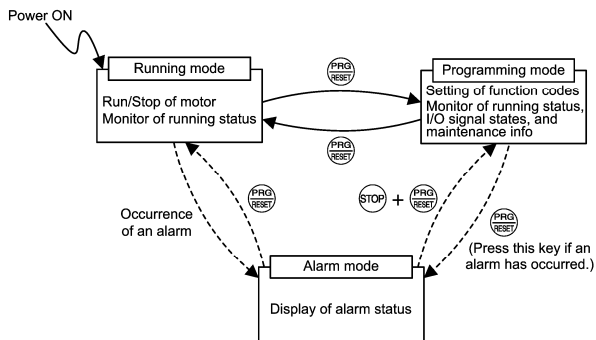
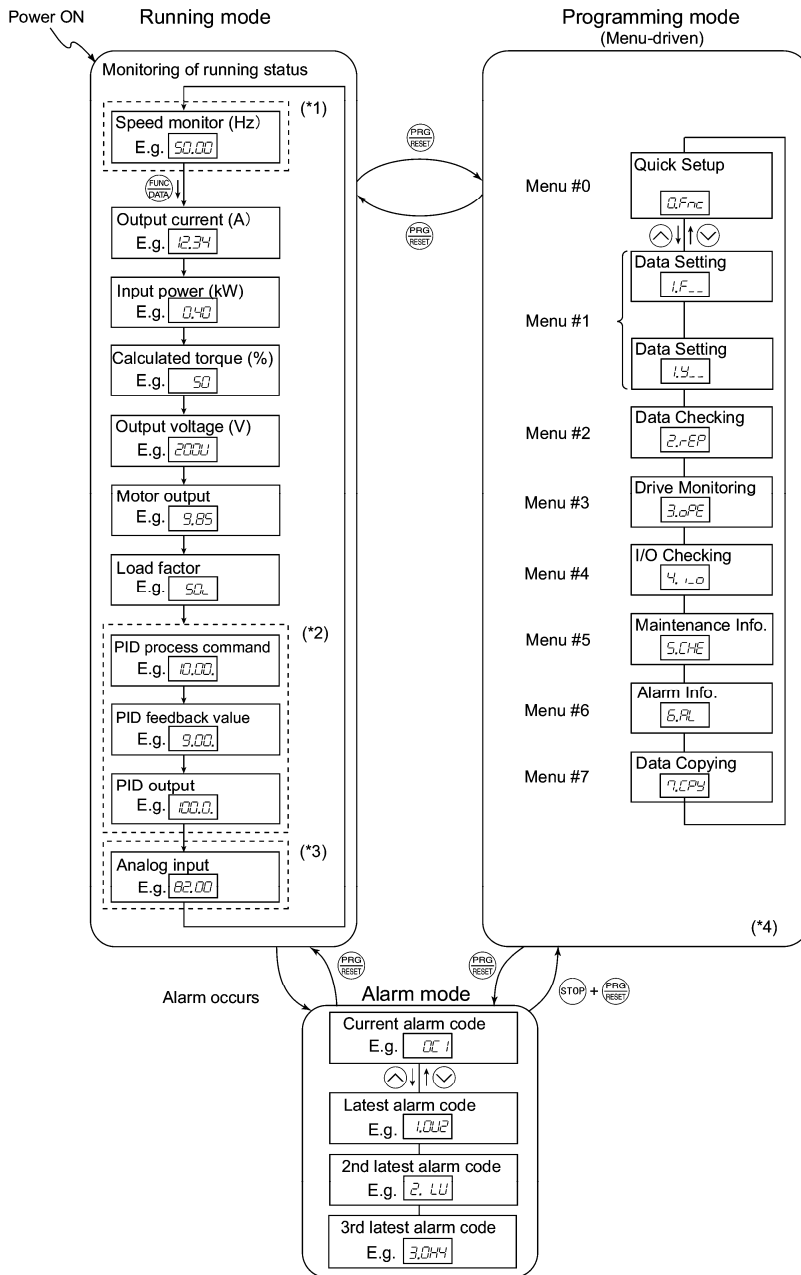

Figure 3.1 Status Transition between Operation Modes

Figure 3.2 illustrates the transition of the LED monitor screen during Running mode, the transition between menu items in Programming mode, and the transition between alarm codes at different occurrences in Alarm mode.



(*1) In speed monitor, you can have any of the following displayed according to the setting of function code E48: Output frequency (Hz), Motor speed (r/min), Load shaft speed (r/min), and Speed (%).

(*2) Applicable only when PID control is active. (J01 = 1 or 2)

(*3) Applicable only when the analog signal input monitor is assigned to any terminals [12], [C1], or [V2] by E61, E62 or E63 (= 20).

(*4) Applicable only when the full-menu mode is active. (E52 = 2)

Figure 3.2 Transition between Basic Display Frames by Operation Mode

3.3 Running Mode

When the inverter is turned on, it automatically enters Running mode. In this mode, you can:

- (1) Monitor the running status (e.g., output frequency, output current),
- (2) Set up the frequency command and others, and
- (3) Run/stop the motor.

3.3.1 Monitoring the running status



In Running mode, the eleven items listed below can be monitored. Immediately after the inverter is turned on, the monitor item specified by function code E43 is displayed. Press the  key to switch between monitor items. For details of switching the monitor item by using the  key, refer to "Monitoring of Running Status" in Figure 3.2 Transition between Basic Display Frames by Operation Mode.

Table 3.3 Monitoring Items

Monitor Items	Display Sample on the LED monitor*1	LED indicator ■: on, □: off	Unit	Meaning of Displayed Value	Function Code E43
Speed monitor	Function code E48 specifies what to be displayed on the LED monitor and LED indicators.				0
Output frequency	50.00	■Hz □A □kW	Hz	Frequency actually being output	(E48 = 0)
Motor speed	1500	■Hz ■A □kW	r/min	Output frequency × $\frac{120}{P01}$	(E48 = 3)
Load shaft speed	300.0	■Hz ■A □kW	r/min	Output frequency (Hz) × E50	(E48 = 4)
Speed (%)	50.0	□Hz □A □kW	%	$\frac{\text{Output frequency}}{\text{Maximum frequency}} \times 100$	(E48 = 7)
Output current	12.34	□Hz ■A □kW	A	Current output from the inverter in RMS	3
Output voltage *2	200.0	□Hz □A □kW	V	Voltage output from the inverter in RMS	4
Calculated output torque	50	□Hz □A □kW	%	Motor output torque in % (Calculated value)	8
Input power	10.25	□Hz □A ■kW	kW	Input power to the inverter	9
PID process command *3, *4	10.00	□Hz □A □kW	—	PID process command/feedback value transformed to that of virtual physical value of the object to be controlled (e.g. Temperature)	10
PID feedback value *3, *5	9.00	□Hz □A □kW	—	Refer to the function codes E40 and E41 for details.	12
PID output *3, *4	100.0	□Hz □A □kW	%	PID output in % as the maximum frequency (F03) being at 100%	14
Load factor *6	50.0	□Hz □A □kW	%	Load factor of the motor in % as the rated output being at 100%	15
Motor output *7	9.85	□Hz □A ■kW	kW	Motor output in kW	16
Analog input *8	82.00	□Hz □A □kW	—	Analog input signal to the inverter, transformed by E40 and E41 Refer to the function codes E40 and E41 for details.	17

*1 A value exceeding 9999 cannot be displayed on the 4-digit LED monitor screen, so "E 3" (7-segment letters) appear instead.

*2 For displaying an output voltage on the LED monitor, the 7-segment letter 'V' is used in the lowest digit as an alternative expression of the unit of the V (volt).

*3 These PID-related items appear only when the inverter PID-controls the motor according to a PID process command specified by the function code J01 (= 1 or 2).

*4 When the LED monitor displays a PID process command or its output amount, the dot (decimal point) attached to the lowest digit of the 7-segment letter blinks.



*5 When the LED monitor displays a PID feedback value, the dot (decimal point) attached to the lowest digit of the 7-segment letter lights.

*6 For displaying a load factor on the LED monitor, the 7-segment letter 'L' is used in the lowest digit as an alternative expression of the unit of %.

*7 When the LED monitor displays the motor output, the unit LED indicator "kW" blinks.







*8 Analog input monitoring becomes active only when any data of the function codes E61, E62 and E63 is effective (= 20) to define a terminal function.

3.3.2 Setting up frequency and PID process commands

You can set up the desired frequency and PID process commands by using the  and  keys on the keypad. It is also possible to set up the frequency command as load shaft speed, motor speed or speed (%) by setting function code E48.













■ Setting up a frequency command

Using the and keys (Factory default)

- (1) Set function code F01 to "0: Enable  /  keys on keypad." This can be done only when the inverter is in Running mode.
- (2) Press the  /  key to display the current reference frequency. The lowest digit will blink.
- (3) If you need to change the frequency command, press the  /  key again. The new setting will be automatically saved into the inverter's internal memory and retained even when the power is off. When the power is turned on next time, the setting will be used as an initial reference frequency.



Tip • The frequency command can be saved either automatically as mentioned above or by pressing the  key. You can choose either way using function code E64.

- If you have set function code F01 to "0: Enable  /  keys on keypad" but have selected a frequency command other than frequency command 1 (i.e., frequency command 2, frequency command via communication, or multistep frequency command), then the  /  keys are disabled to change the current frequency command even in Running mode. Pressing either of these keys just displays the current reference frequency.
- When you start specifying or changing the frequency command or any other parameter with the  /  key, the lowest digit on the display blinks and starts changing. As you are holding down the key, blinking will gradually move to the upper digit places and the upper digits will be changeable.
- If you press the  /  key once and then hold down the  key for more than 1 second after the lowest digit starts blinking, blinking will move to the next upper digit place to allow you to change the value of that digit (cursor movement). This way you can easily change the values of the higher digits.
- By setting function code C30 to "0: Enable  /  keys on keypad" and selecting frequency command 2, you can also specify or change the frequency command in the same manner using the  /  key.

You can set up a frequency command not only with the frequency (Hz) but also with other menu items (Motor speed, load shaft speed, and speed (%)) depending on the setting of function code E48 (= 3, 4, or 7) "Speed monitor items" as shown in Table 3.3.

■ Make setting under PID control

To enable PID control, you need to set function code J01 to 1 or 2.

Under the PID control, the items that can be set or checked with the \triangleleft and \triangleright keys are different from those under regular frequency control, depending upon the current LED monitor setting. If the LED monitor is set to the speed monitor (E43 = 0), you can access manual speed commands (Frequency command) with the \triangleleft and \triangleright keys; if it is set to any other, you can access the PID process command with those keys.

 Refer to the FRENIC-Eco User's Manual (MEH456), Chapter 4, Section 4.9, "PID Frequency Command Generator" for details on the PID control.

Setting the PID process command with the \triangleleft and \triangleright keys

- (1) Set function code J02 to "0: Enable \triangleleft / \triangleright keys on keypad."
- (2) Set the LED monitor to something other than the speed monitor (E43 = 0) when the inverter is in Running mode. When the keypad is in Programming or Alarm mode, you cannot modify the PID process command with the \triangleleft / \triangleright key. To enable the PID process command to be modified with the \triangleleft / \triangleright key, first switch to Running mode.
- (3) Press the \triangleleft / \triangleright key to have the PID process command displayed. The lowest digit will blink on the LED monitor.
- (4) To change the PID process command, press the \triangleleft / \triangleright key again. The PID process command you have specified will be automatically saved into the inverter's internal memory. It is kept there even if you temporarily switch to another means of specifying the PID process command and then go back to the means of specifying the PID process command via the keypad. Also, it is kept there even while the inverter is powered off, and will be used as the initial PID process command next time the inverter is powered on.

-  Tip
- Even if multistep frequency is selected as the PID process command ((SS4) = ON), you still can set the process command using the keypad.
 - When function code J02 is set to any value other than 0, pressing the \triangleleft / \triangleright key displays, on the 7-segment LED monitor, the PID command currently selected, while you cannot change the setting.
 - On the 7-segment LED monitor, the decimal point of the lowest digit is used to characterize what is displayed. The decimal point of the lowest digit blinks when a PID process command is displayed; the decimal point lights when a PID feedback value is displayed.

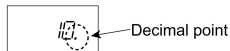

Table 3.4 PID Process Command Manually Set with the \triangleleft / \triangleright Key and Requirements

PID Control (Selection) J01	PID Control (Remote Process Command) J02	LED Monitor E43	Multistep Frequency (SS4)	With the \triangleleft / \triangleright key
1 or 2	0	Other than 0	ON or OFF	PID process command <u>by keypad</u>
	Other than 0			PID process command <u>currently selected</u>

Setting up the frequency command with the \triangleleft and \triangleright keys under PID control

When function code F01 is set to "0: Enable \triangleleft / \triangleright keys on keypad" and frequency command 1 is selected as a manual speed command (that is, disabling the frequency setting command via communications link and multistep frequency command), switching the LED monitor to the speed monitor in Running mode enables you to modify the frequency command with the \triangleleft / \triangleright keys.

In Programming or Alarm mode, the \triangleleft / \triangleright keys are disabled to modify the frequency command. You need to switch to Running mode.

Table 3.5 lists the combinations of the commands and the figure illustrates how the manual speed command ① entered via the keypad is translated to the final frequency command ②.

The setting procedure is the same as that for setting of a usual frequency command.

Table 3.5 Manual Speed (Frequency) Command Set with the \triangleleft / \triangleright Keys and Requirements

PID Control (Selection) J01	LED Monitor E43	Frequency Command 1 F01	Multistep Frequency (SS2)	Multistep Frequency (SS1)	Link Operation Selection (LE)	Disable PID Control (Hz/PID)	Pressing the \triangleleft / \triangleright keys controls:	
1 or 2	0	0	OFF	OFF	OFF	OFF (PID enabled)	PID output (as final frequency command)	
						ON (PID disabled)	Manual speed (frequency) command set by keypad	
		Other than the above					OFF (PID enabled)	PID output (as final frequency command)
							ON (PID disabled)	Manual speed (frequency) command currently selected

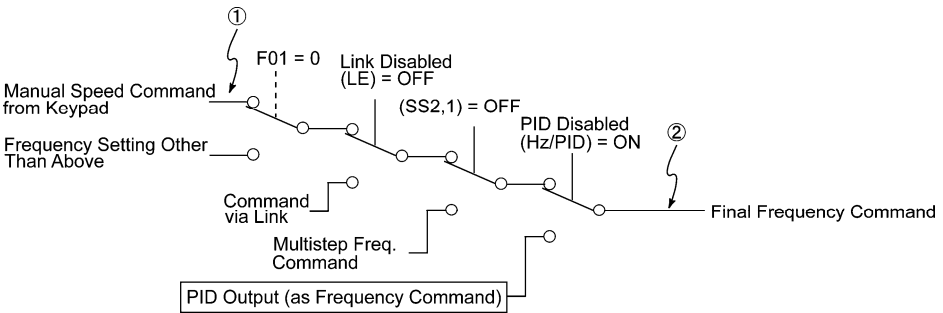

3.3.3 Running/stopping the motor

By factory default, pressing the **Ⓜ** key starts running the motor in the forward direction and pressing the **Ⓜ** key decelerates the motor to stop. The **Ⓜ** key is enabled only in Running mode.

The motor rotational direction can be selected by changing the setting of function code F02.



■ Operational relationship between function code F02 (Run command) and **Ⓜ** key

Table 3.6 lists the relationship between function code F02 settings and the **Ⓜ** key, which determines the motor rotational direction.

Table 3.6 Motor Rotational Direction Specified by F02

Data for F02	Pressing the Ⓜ key runs the motor:
0	In the direction commanded by the terminal [FWD] or [REV]
1	Ⓜ key disabled (The motor is driven by terminal command [FWD] or [REV].)
2	In the forward direction
3	In the reverse direction

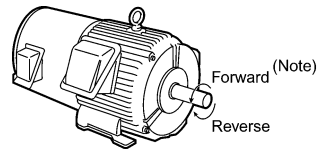

(Note) The rotational direction of IEC-compliant motors is opposite to that of the motor shown here.

For the details on operations with function code F02, refer to Chapter 5 “FUNCTION CODES.”

Note When the keypad is in use for specifying the frequency settings or driving the motor, do not disconnect the keypad from the inverter when the motor is running. Doing so may stop the inverter.

■ Remote and local modes













The inverter can be operated either in remote or local mode. In remote mode that applies to ordinary operation, the inverter is driven under the control of the data settings stored in the inverter, whereas in local mode that applies to maintenance operation, it is separated from the control system and is driven manually under the control of the keypad.

- Remote mode: The run and frequency commands are selected by source switching signals including function codes, run command 2/1 signals,, and communications link operation signal.
- Local mode: The command source is the keypad, regardless of the settings specified by function codes. The keypad takes precedence over the settings specified by run command 2/1 signals or communications link operation signal.

Run commands from the keypad in local mode

The table below shows the input procedures of run commands from the keypad in local mode.

Table 3.7 Run Commands from the Keypad in Local Mode

When Data for F02 (Run command) is :	Input Procedures of Run Commands from Keypad
0: Enable  /  keys on keypad (Motor rotational direction from digital terminals [FWD]/[REV])	Pressing the  key runs the motor in the direction specified by command (FWD) or (REV) assigned to terminal [FWD] or [REV], respectively. Pressing the  key stops the motor.
1: Enable terminal command (FWD)/(REV)	Pressing the  key runs the motor in the forward direction only. Pressing the  key stops the motor. No specification of the motor rotational direction is required.
2: Enable  /  keys on keypad (Forward)	
3: Enable  /  keys on keypad (Reverse)	Pressing the  key runs the motor in the reverse direction only. Pressing the  key stops the motor. No specification of the motor rotational direction is required.

Switching between remote and local modes

The remote and local modes can be switched by a digital input signal provided from the outside of the inverter.

To enable the switching, you need to assign (LOC) as a digital input signal to any of terminals [X1] to [X5] by setting "35" to any of E01 to E05, E98 and E99. By factory default, (LOC) is assigned to [X5].

Switching from remote to local mode automatically inherits the frequency settings used in remote mode. If the motor is running at the time of the switching from remote to local, the run command is automatically turned on so that all the necessary data settings will be carried over. If, however, there is a discrepancy between the settings used in remote mode and ones made on the keypad (e.g., switching from the reverse rotation in remote mode to the forward rotation only in local mode), the inverter automatically stops.

The transition paths between remote and local modes depend on the current mode and the value (on/off) of (LOC), as shown in the status transition diagram given below. Also, refer to Table 3.7 "Run Commands from the Keypad in Local Mode" for details.

 For further details on how to specify run and frequency commands in remote and local modes, refer to the FRENIC-Eco User's Manual (MEH456), Chapter 4, Section 4.3, "Drive Command Generator."

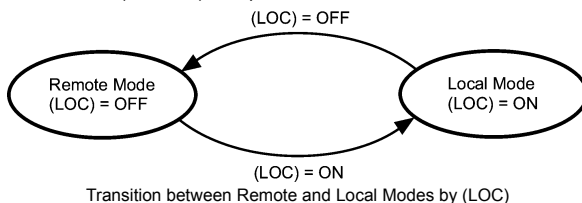

3.4 Programming Mode

The Programming mode provides you with these functions--setting and checking function code data, monitoring maintenance information and checking input/output (I/O) signal status. The functions can be easily selected with the menu-driven system. Table 3.8 lists menus available in Programming mode. The leftmost digit (numerals) of each letter string on the LED monitor indicates the corresponding menu number and the remaining three digits indicate the menu contents.

When the inverter enters Programming mode from the second time on, the menu selected last in Programming mode will be displayed.

Table 3.8 Menus Available in Programming Mode

Menu #	Menu	LED monitor shows:	Main functions	Refer to:	
0	"Quick Setup"	<i>Q.F.r.c</i>	Displays only basic function codes to customize the inverter operation.	Section 3.4.1	
1	"Data Setting"	<i>f_ _</i>	F codes (Fundamental functions)	Selecting each of these function codes enables its data to be displayed/changed.	Section 3.4.2
		<i>e_ _</i>	E codes (Extension terminal functions)		
		<i>c_ _</i>	C codes (Control functions of frequency)		
		<i>p_ _</i>	P codes (Motor parameters)		
		<i>h_ _</i>	H codes (High performance functions)		
		<i>w_ _</i>	J codes (Application functions)		
		<i>y_ _</i>	y codes (Link functions)		
		<i>o_ _</i>	o code (Optional function) (Note)		
2	"Data Checking"	<i>2.F.E.P</i>	Displays only function codes that have been changed from their factory defaults. You can refer to or change those function code data.	Section 3.4.3	
3	"Drive Monitoring"	<i>3.o.P.E</i>	Displays the running information required for maintenance or test running.	Section 3.4.4	
4	"I/O Checking"	<i>4. I. O</i>	Displays external interface information.	Section 3.4.5	
5	"Maintenance Information"	<i>5.C.H.E</i>	Displays maintenance information including cumulative run time.	Section 3.4.6	
6	"Alarm Information"	<i>6.A.L</i>	Displays the latest four alarm codes. You may refer to the running information at the time when the alarm occurred.	Section 3.4.7	
7	"Data Copying"	<i>7.C.P.Y</i>	Allows you to read or write function code data, as well as verifying it.	Section 3.4.8	

(Note) An o code appears only when any option is mounted on the inverter. For details, refer to the instruction manual of the corresponding option.

Figure 3.3 illustrates the menu-driven function code system in Programming mode.

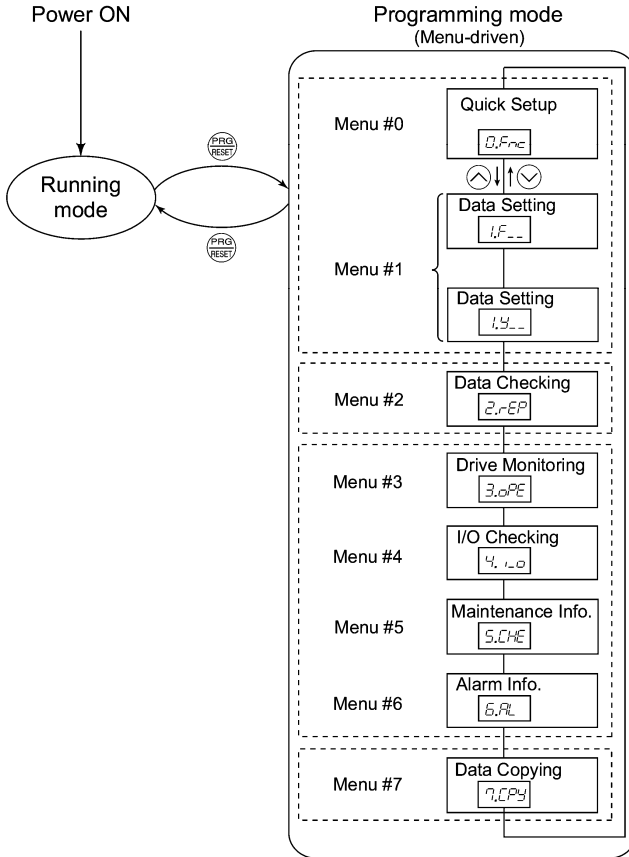

Figure 3.3 Menu Transition in the Programming Mode

■ Limiting menus to be displayed

The menu-driven system has a limiter function (specified by function code E52) that limits menus to be displayed for the purpose of simple operation. The factory default (E52 = 0) is to display only three menus--Menu #0 "Quick Setup," Menu #1 "Data Setting" and Menu #7 "Data Copying," allowing no switching to any other menu.

Table 3.9 Keypad Display Mode Selection – Function Code E52

Data for E52	Mode	Menu selectable
0	Function code data editing mode (factory default)	Menu #0 "Quick Setup" Menu #1 "Data Setting" Menu #7 "Data Copying"
1	Function code data check mode	Menu #2 "Data Checking" Menu #7 "Data Copying"
2	Full-menu mode	Menu #0 through #7

Tip Pressing the \uparrow/\downarrow key will cycle through the menu. With the PRG/RESET key, you can select the desired menu item. Once the entire menu has been cycled through, the display will return to the first menu item.

3.4.1 Setting up basic function codes quickly – Menu #0 "Quick Setup"

Menu #0 "Quick Setup" in Programming mode allows you to quickly display and set up a basic set of function codes specified in Chapter 5, Section 5.1, "Function Code Tables."

To use Menu #0 "Quick Setup," you need to set function code E52 to "0: Function code data editing mode" or "2: Full-menu mode."

The predefined set of function codes that are subject to quick setup are held in the inverter.

Listed below are the function codes (including those not subject to quick setup) available on the FRENIC-Eco. A function code is displayed on the LED monitor on the keypad in the following format:

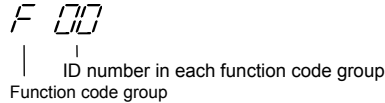



Table 3.10 Function Codes Available on FRENIC-Eco





Function Code Group	Function Codes	Function	Description
F codes	F00 to F44	Fundamental functions	Functions concerning basic motor running
E codes	E01 to E99	Extension terminal functions	Functions concerning the assignment of control circuit terminals Functions concerning the display of the LED monitor
C codes	C01 to C53	Control functions of frequency	Functions associated with frequency settings
P codes	P01 to P99	Motor parameters	Functions for setting up characteristics parameters (such as capacity) of the motor
H codes	H03 to H98	High performance functions	Highly added-value functions Functions for sophisticated control
J codes	J01 to J22	Application functions	Functions for applications such as PID Control
y codes	y01 to y99	Link functions	Functions for controlling communication
o codes	o27 to o59	Optional functions	Functions for options (Note)

(Note) The o codes are displayed only when the corresponding option is mounted.

For details of the o codes, refer to the Instruction Manual for the corresponding option.

 For the list of function codes subject to quick setup and their descriptions, refer to Chapter 5, Section 5.1 "Function Code Tables."

■ Function codes requiring simultaneous keying

To modify the data for function code F00 (Data protection), H03 (Data initialization), or H97 (Clear alarm data), simultaneous keying is needed, involving the  +  keys or  +  keys.

■ Changing, validating, and saving function code data when the inverter is running

Some function code data can be changed while the inverter is running, whereas others cannot. Further, depending on the function code, modifications may or may not validate immediately. For details, refer to the "Change when running" column in Chapter 5, Section 5.1 "Function Code Tables."

 For details of function codes, refer to Chapter 5, Section 5.1 "Function Code Tables."

Basic key operation

This section gives a description of the basic key operation, following the example of the function code data changing procedure shown in Figure 3.5.

This example shows you how to change function code F01 data from the factory default "0: Enable \triangleleft / \triangleright keys on keypad" to "2: Enable current input to terminal [C1] (4 to 20 mA DC)."

- (1) Turn the inverter on. It automatically enters Running mode. In that mode, press the PRG/RESET key to switch to Programming mode. The function selection menu appears. (In this example, 0.Frc is displayed.)
- (2) If anything other than 0.Frc is displayed, use the \triangleleft and \triangleright keys to display 0.Frc .
- (3) Press the FUNC/DATA key to proceed to a list of function codes.
- (4) Use the \triangleleft and \triangleright keys to display the desired function code (F 01 in this example), then press the FUNC/DATA key. The data of this function code appears. (In this example, data 0 of F 01 appears.)
- (5) Change the function code data using the \triangleleft and \triangleright keys. (In this example, press the \triangleleft key two times to change data 0 to 2 .)
- (6) Press the FUNC/DATA key to establish the function code data. The SAVE appears and the data will be saved in the memory inside the inverter. The display will return to the function code list, then move to the next function code. (In this example, F 02 .)
Pressing the PRG/RESET key instead of the FUNC/DATA key cancels the change made to the data. The data reverts to the previous value, the display returns to the function code list, and the original function code reappears.
- (7) Press the PRG/RESET key to return to the menu from the function code list.

Tip Cursor movement

You can move the cursor when changing function code data by holding down the PRG/RESET key for 1 second or longer in the same way as with the frequency settings. This action is called "Cursor movement."

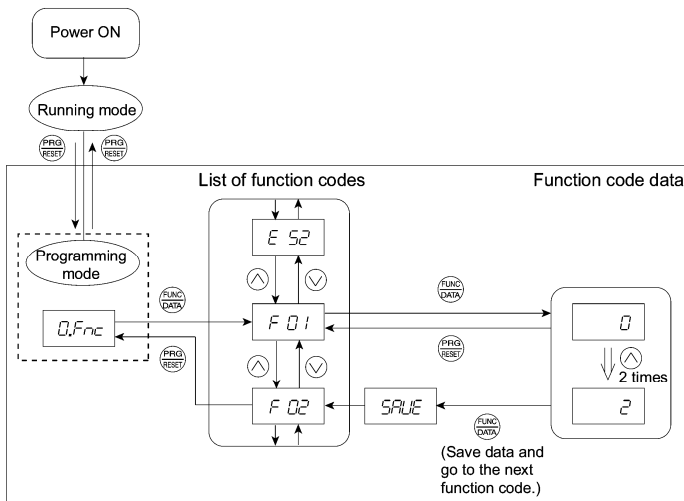

Figure 3.5 Example of Function Code Data Changing Procedure

3.4.2 Setting up function codes – Menu #1 "Data Setting"

Menu #1 "Data Setting" in Programming mode allows you to set up function codes for making the inverter functions match your needs.

To set function codes in this menu, it is necessary to set function code E52 to "0: Function code data editing mode" or "2: Full-menu mode."

Figure 3.6 shows the menu transition in Menu #1 "Data Setting."

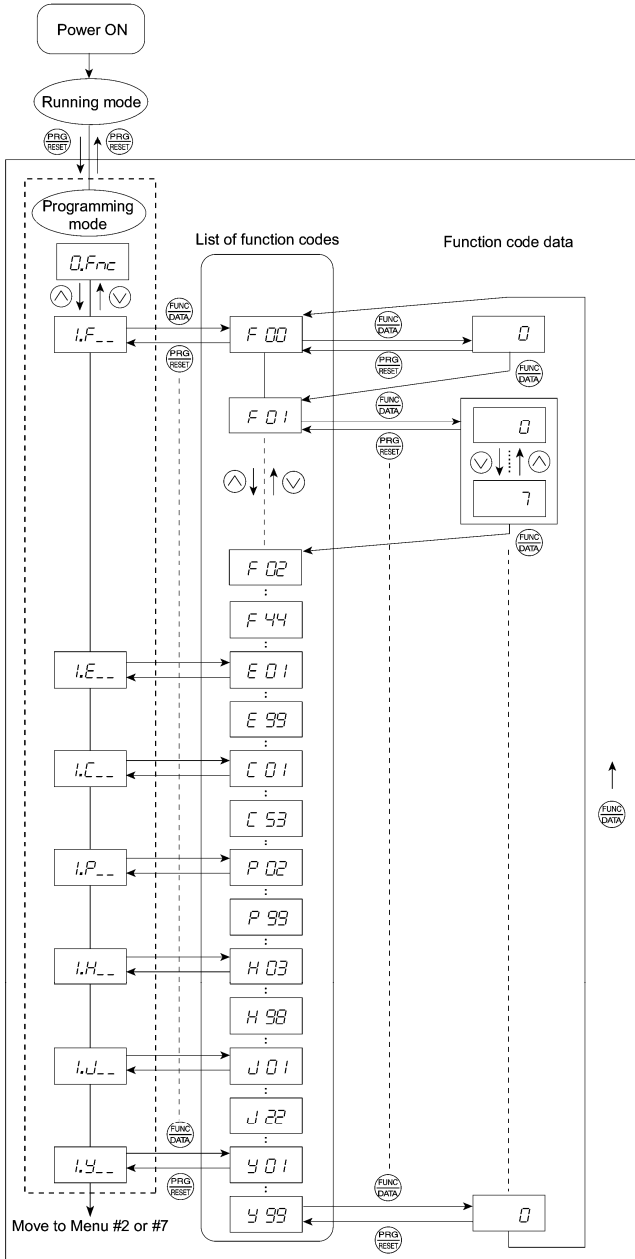

Figure 3.6 Menu Transition in Menu #1 "Data Setting"

Basic key operation

For details of the basic key operation, refer to Menu #0 "Quick Setup" in Section 3.4.1.

3.4.4 Monitoring the running status – Menu #3 "Drive Monitoring"

Menu #3 "Drive Monitoring" is used to monitor the running status during maintenance and trial running. The display items for "Drive Monitoring" are listed in Table 3.11. Figure 3.8 shows the menu transition in Menu #3 "Drive Monitoring."

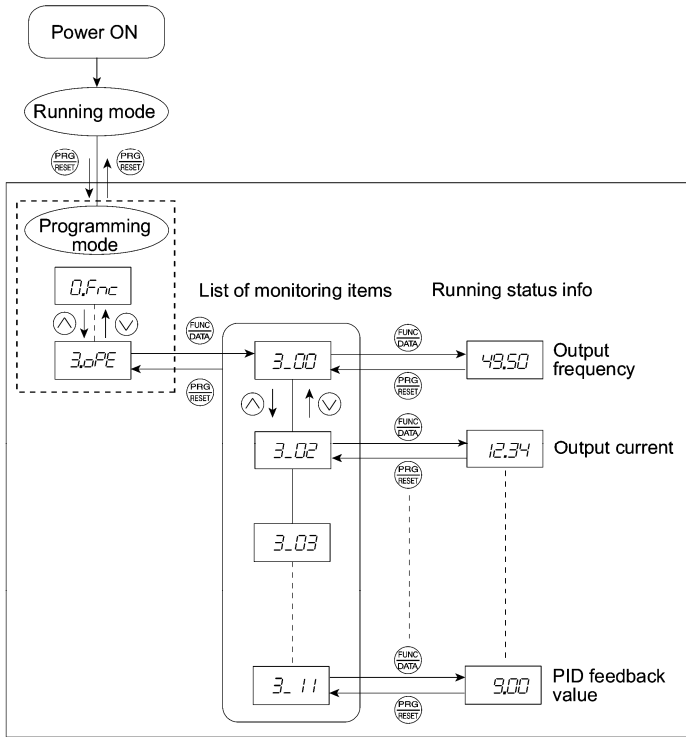

Figure 3.8 Menu Transition in Menu #3 "Drive Monitoring"

Basic key operation

To monitor the running status on the drive monitor, set function code E52 to "2: Full-menu mode" beforehand.

- (1) Turn the inverter on. It automatically enters Running mode. In that mode, press the key to switch to Programming mode. The function selection menu appears.
- (2) Use the and keys to display "Drive Monitoring" (3.0PE).
- (3) Press the key to proceed to a list of monitoring items (e.g. 3.00).
- (4) Use the and keys to display the desired monitoring item, then press the key.
The running status information for the selected item appears.
- (5) Press the key to return to a list of monitoring items. Press the key again to return to the menu.

Table 3.11 Drive Monitor Display Items

LED monitor shows:	Item	Unit	Description
3.00	Output frequency	Hz	Output frequency
3.02	Output current	A	Output current
3.03	Output voltage	V	Output voltage
3.04	Calculated Torque	%	Calculated output torque of the loaded motor in %
3.05	Reference frequency	Hz	Frequency specified by a frequency command
3.06	Rotational direction	N/A	Rotational direction being outputted F: forward; r: reverse, ----: stop
3.07	Running status	N/A	Running status in hexadecimal format Refer to " ■ Displaying running status " on the next page.
3.08	Motor speed	r/min	Display value = (Output frequency Hz) × $\frac{120}{(\text{Function code P01})}$
3.09	Load shaft speed	r/min	Display value = (Output frequency Hz) × (Function code E50) The 7-segment letters $\text{C } \text{ } \text{}$ appear for 10000 (r/min) or more. If $\text{C } \text{ } \text{}$ appear, decrease function code E52 data so that the LED monitor displays 9999 or below, referring to the above equation.
3.10	PID process command	N/A	Virtual physical value (e.g., temperature or pressure) of the object to be controlled, which is converted from the PID process command using function code E40 and E41 data (PID display coefficients A and B) Display value = (PID process command) × (Coefficient A - B) + B If PID control is disabled, "----" appears.
3.11	PID feedback value	N/A	Virtual physical value (e.g., temperature or pressure) of the object to be controlled, which is converted from the PID process command using function code E40 and E41 data (PID display coefficients A and B) Display value = (PID feedback value) × (Coefficient A - B) + B If PID control is disabled, "----" appears.

■ Displaying running status

To display the running status in hexadecimal format, each state has been assigned to bits 0 to 15 as listed in Table 3.12. Table 3.13 shows the relationship between each of the status assignments and the LED monitor display. Table 3.14 gives the conversion table from 4-bit binary to hexadecimal.

Table 3.12 Running Status Bit Assignment

Bit	Notation	Content	Bit	Notation	Content
15	BUSY	1 when function code data is being written.	7	VL	1 under voltage limiting control.
14	WR	Always 0.	6	TL	Always 0.
13		Always 0.	5	NUV	1 when the DC link bus voltage is higher than the undervoltage level.
12	RL	1 when communication is enabled (when ready for run and frequency commands via communications link).	4	BRK	1 during braking
11	ALM	1 when an alarm has occurred.	3	INT	1 when the inverter output is shut down.
10	DEC	1 during deceleration.	2	EXT	1 during DC braking.
9	ACC	1 during acceleration.	1	REV	1 during running in the reverse direction.
8	IL	1 under current limiting control.	0	FWD	1 during running in the forward direction.

Table 3.13 Running Status Display

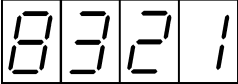
LED No.		LED4				LED3				LED2				LED1			
Bit		15	14	13	12	11	10	9	8	7	6	5	4	3	2	1	0
Notation		BUSY	WR	RL	ALM	DEC	ACC	IL	VL	TL	NUV	BRK	INT	EXT	REV	FWD	
Example	Binary	1	0	0	0	0	0	1	1	0	0	1	0	0	0	0	1
	Hexadecimal on the LED monitor	<div style="display: flex; justify-content: space-around; align-items: center;"> LED4 LED3 LED2 LED1 </div> 															

■ Hexadecimal expression

A 4-bit binary number can be expressed in hexadecimal format (1 hexadecimal digit). Table 3.14 shows the correspondence between the two notations. The hexadecimals are shown as they appear on the LED monitor.

Table 3.14 Binary and Hexadecimal Conversion

Binary				Hexadecimal	Binary				Hexadecimal
0	0	0	0	0	1	0	0	0	8
0	0	0	1	1	1	0	0	1	9
0	0	1	0	2	1	0	1	0	A
0	0	1	1	3	1	0	1	1	b
0	1	0	0	4	1	1	0	0	C
0	1	0	1	5	1	1	0	1	d
0	1	1	0	6	1	1	1	0	E
0	1	1	1	7	1	1	1	1	F

3.4.5 Checking I/O signal status – Menu #4 "I/O Checking"

Using Menu #4 "I/O Checking" displays the I/O status of external signals including digital and analog I/O signals without using a measuring instrument. Table 3.15 lists check items available. The menu transition in Menu #4 "I/O Checking" is shown in Figure 3.9.

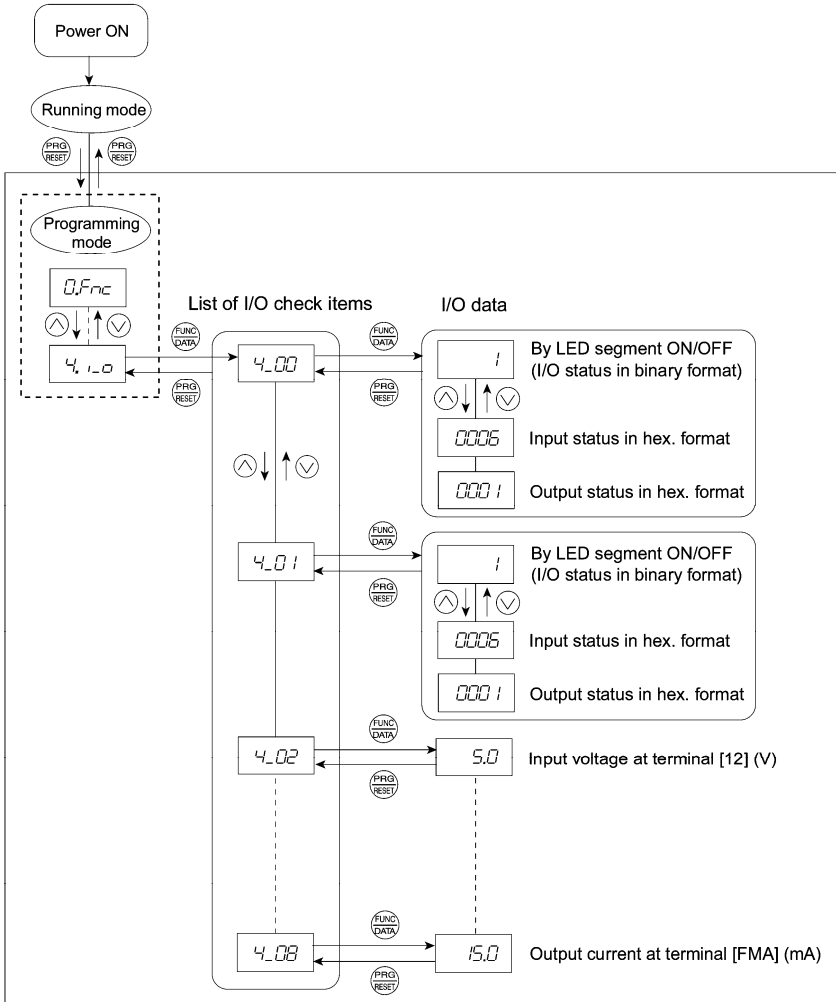











Figure 3.9 Menu Transition in Menu #4 "I/O Checking"

Basic key operation

To check the status of the I/O signals, set function code E52 to "2: Full-menu mode" beforehand.

- (1) Turn the inverter on. It automatically enters Running mode. In that mode, press the  key to switch to Programming mode. The function selection menu appears.
- (2) Use the  and  keys to display "I/O Checking" (4_1_0).
- (3) Press the  key to proceed to a list of I/O check items (e.g. 4_00).
- (4) Use the  and  keys to display the desired I/O check item, then press the  key.

The corresponding I/O check data appears. For the item 4_00 or 4_01, using the  and  keys switches the display method between the segment display (for external signal information in Table 3.16) and hexadecimal display (for I/O signal status in Table 3.17).



- (5) Press the  key to return to a list of I/O check items. Press the  key again to return to the menu.

Table 3.15 I/O Check Items

LED monitor shows:	Item	Description
4_00	I/O signals on the control circuit terminals	Shows the ON/OFF state of the digital I/O terminals. Refer to "■ Displaying control I/O signal terminals" on the next page for details.
4_01	I/O signals on the control circuit terminals under communication control	Shows the ON/OFF state for the digital I/O terminals that received a command via RS485 and optional communications. Refer to "■ Displaying control I/O signal terminals" and "■ Displaying control I/O signal terminals under communications control" on the following pages for details.
4_02	Input voltage on terminal [12]	Shows the input voltage on terminal [12] in volts (V).
4_03	Input current on terminal [C1]	Shows the input current on terminal [C1] in milliamperes (mA).
4_04	Output voltage to analog meters [FMA]	Shows the output voltage on terminal [FMA] in volts (V).
4_05 *	Output voltage to digital meters [FMP]	Shows the output voltage on terminal [FMP] in volts (V).
4_06 *	Pulse rate of [FMP]	Shows the output pulse rate on terminal [FMP] in p/s (pulses per second).
4_07	Input voltage on terminal [V2]	Shows the input voltage on terminal [V2] in volts (V).
4_08	Output current to analog meters [FMA]	Shows the output current on terminal [FMA] in mA.
4_09 *	Output current to analog meters [FMI]	Shows the output current on terminal [FMI] in mA.

* The inverter has either [FMP] or [FMI] depending on the type of the control printed circuit board (control PCB). The control PCB with a screw terminal base has [FMP] and it does not display 4_09; the one with a Europe type terminal block has [FMI] and it does not display 4_05 or 4_06.

■ Displaying control I/O signal terminals

The status of control I/O signal terminal may be displayed with ON/OFF of the LED segment or in hexadecimal display.

- Display I/O signal status with ON/OFF of each LED segment

As shown in Table 3.16 and the figure below, each of segments "a" to "g" on LED1 lights when the corresponding digital input terminal circuit ([FWD], [REV], [X1], [X2], [X3], [X4] or [X5]) is closed; it goes off when it is open ^(*). Segment "a to c" and "e" on LED3 lights when the circuit between output terminal [Y1], [Y2], or [Y3] and terminal [CMY], or [Y5A] and [Y5C] is closed, and does not light when the circuit is open. Segment "a" and "e to g" on LED4 lights when the circuit between terminals [30A/B/C], and terminals [Y1A], [Y2A] and [Y3A] on the relay output option card. Segment "a" or "e to g" on LED4 lights when the circuit between terminals [30C] and [30A] or the relay terminal circuit of [Y1A], [Y2A] or [Y3A] is short-circuited (ON) respectively and does not light when it is open.









 Tip If all terminal input signals are OFF (open), segments "g" on all of LED1 to LED4 will blink ("----").

Table 3.16 Segment Display for External Signal Information

LED4 LED3 LED2 LED1	Segment	LED4	LED3	LED2	LED1
	a	30A/B/C	Y1-CMY	—	FWD ^(*)
	b	—	Y2-CMY	—	REV ^(*)
	c	—	Y3-CMY	—	X1 ^(*)
	d	—	—	—	X2 ^(*)
	e	Y1A	Y5A-Y5C	—	X3 ^(*)
	f	Y2A	—	(XF) ^(*)	X4 ^(*)
	g	Y3A	—	(XR) ^(*)	X5 ^(*)
	dp	—	—	(RST) ^(*)	—

—: No corresponding control circuit terminal exists.

^(*) For the open/close states of [FWD], [REV], [X1] through [X5] circuits, refer to the setting of the SINK/SOURCE slide switch in Chapter 2, Table 2.11 "Symbols, Names and Functions of the Control Circuit Terminals."

^(*) (XF), (XR), and (RST) are assigned for communication. Refer to "■ Displaying control I/O signal terminals under communications control" on the next page.

- Displaying I/O signal status in hexadecimal format

Each I/O terminal is assigned to bit 15 through bit 0 as shown in Table 3.17. An unassigned bit is interpreted as "0." Allocated bit data is displayed on the LED monitor in 4 hexadecimal digits (LED4 to LED1).

With the FRENIC-Eco, digital input terminals [FWD] and [REV] are assigned to bit 0 and bit 1, respectively. Terminals [X1] through [X5] are assigned to bits 2 through 6. The bit is set to "1" when the corresponding input terminal is short-circuited (ON)*, and is set to "0" when it is open (OFF). For example, when [FWD] and [X1] are on (short-circuited) and all the others are off (open), 0005 is displayed on LED4 to LED1.

* For the open/close states of [FWD], [REV], [X1] through [X5] circuits, refer to the setting of the SINK/SOURCE slide switch in Chapter 2, Table 2.11 "Symbols, Names and Functions of the Control Circuit Terminals."

Digital output terminal [Y1] to [Y3] are assigned to bits 0 to 2. Each bit is set to "1" when the terminal is short-circuited with [CMY], and "0" when it is open. The status of the relay contact output [Y5A/C] is assigned to bit 4 and it is set to "1" when the circuit between [Y5A] and [Y5C] is closed.

The status of the relay contact output terminal [30A/B/C] is assigned to bit 8. It is set to "1" when the circuit between output terminals [30A] and [30C] is closed, and "0" when the circuit between [30B] and [30C] is closed.

The status of the relay contact output terminals [Y1A] to [Y3A] is assigned to bits 12 to 14. Each bit is set to "1" when the terminal circuits of [Y1A] to [Y1C] are closed, and "0" when they are open.

For example, if [Y1] is on, the circuit between [Y5A] and [Y5C] is open, the circuit between [30A] and [30C] is closed, and all [Y1A] to [Y3A] are open, then "0005" is displayed on the LED4 to LED1.

Table 3.17 presents an example of bit assignment and corresponding hexadecimal display on the 7-segment LED.

Table 3.17 Segment Display for I/O Signal Status in Hexadecimal Format

LED No.	LED4				LED3				LED2				LED1			
	15	14	13	12	11	10	9	8	7	6	5	4	3	2	1	0
Input terminal	(RST)*	(XR)*	(XF)*	-	-	-	-	-	-	X5	X4	X3	X2	X1	REV	FWD
Output terminal	-	Y3A	Y2A	Y1A	-	-	-	30 A/B/C	-	-	-	Y5A/C	-	Y3	Y2	Y1
Example	Binary	0	0	0	0	0	0	0	0	0	0	0	0	1	0	1
	Hexadecimal on the LED monitor	 LED4 LED3 LED2 LED1														

- No corresponding control terminal exists.

* (XF), (XR), and (RST) are assigned for communication. Refer to "**■ Displaying control I/O signal terminals under communications control**" below.

■ Displaying control I/O signal terminals under communications control

Under communications control, input commands (function code S06) sent via RS485 or other optional communications can be displayed in two ways: "with ON/OFF of each LED segment" and "in hexadecimal format." The content to be displayed is basically the same as that for the control I/O signal terminal status display; however, (XF), (XR), and (RST) are added as inputs. Note that under communications control, the I/O display is in normal logic (using the original signals not inverted).

 Refer to the RS485 Communication User's Manual (MEH448a) for details on input commands sent through RS485 communications and the instruction manual of communication-related options as well.

3.4.6 Reading maintenance information – Menu #5 "Maintenance Information"

Menu #5 "Maintenance Information" contains information necessary for performing maintenance on the inverter. Table 3.18 lists the maintenance information display items and Figure 3.10 shows the menu transition in Menu #5 "Maintenance information."

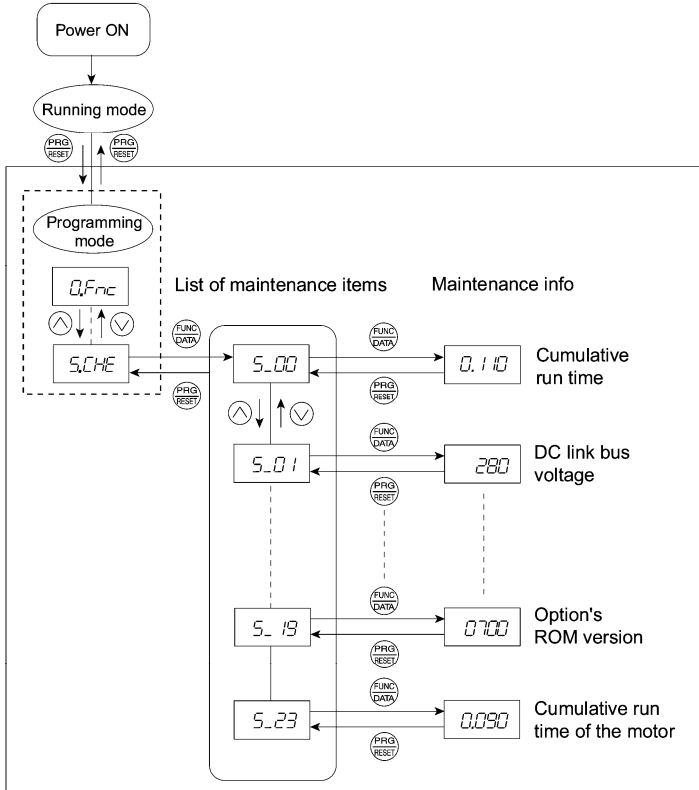

Figure 3.10 Menu Transition in Menu #5 "Maintenance Information"

Basic key operation

To view the maintenance information, set function code E52 to "2: Full-menu mode" beforehand.

- (1) Turn the inverter on. It automatically enters Running mode. In that mode, press the **PRG/RESET** key to switch to Programming mode. The function selection menu appears.
- (2) Use the **▲** and **▼** keys to display "Maintenance Information" (S.CHE).
- (3) Press the **FUNC/DATA** key to proceed to a list of maintenance item codes (e.g. 5_00).
- (4) Use the **▲** and **▼** keys to display the desired maintenance item, then press the **FUNC/DATA** key. The data of the corresponding maintenance item appears.
- (5) Press the **PRG/RESET** key to return to a list of maintenance items. Press the **PRG/RESET** key again to return to the menu.

Table 3.18 Display Items for Maintenance Information

LED Monitor shows:	Item	Description
<i>5_00</i>	Cumulative run time	Shows the content of the cumulative power-ON time counter of the inverter. Unit: thousands of hours. (Display range: 0.001 to 9.999, 10.00 to 65.53) When the total ON-time is less than 10000 hours (display: 0.001 to 9.999), data is shown in units of one hour (0.001). When the total time is 10000 hours or more (display: 10.00 to 65.53), it is shown in units of 10 hours (0.01). When the total time exceeds 65535 hours, the counter will be reset to 0 and the count will start again.
<i>5_01</i>	DC link bus voltage	Shows the DC link bus voltage of the inverter main circuit. Unit: V (volts)
<i>5_02</i>	Max. temperature inside the inverter	Shows a maximum temperature inside the inverter for every hour. Unit: °C (Temperatures below 20°C are displayed as 20°C.)
<i>5_03</i>	Max. temperature of heat sink	Shows the maximum temperature of the heat sink for every hour. Unit: °C (Temperatures below 20°C are displayed as 20°C.)
<i>5_04</i>	Max. effective output current	Shows the maximum current in RMS for every hour. Unit: A (amperes)
<i>5_05</i>	Capacitance of the DC link bus capacitor	Shows the current capacitance of the DC link bus capacitor (reservoir capacitor) in %, based on the capacitance when shipping as 100%. Refer to Chapter 7 "MAINTENANCE AND INSPECTION" for details. Unit: %
<i>5_06</i>	Cumulative run time of electrolytic capacitor on the printed circuit board	Shows the content of the cumulative run time counter of the electrolytic capacitor mounted on the printed circuit board. Unit: thousands of hours.(Display range: 0.001 to 9.999, 10.00 to 99.99*1) When the total ON-time is less than 10000 hours (display: 0.001 to 9.999), data is shown in units of one hour (0.001). When the total time is 10000 hours or more (display: 10.00 to 99.99*1), it is shown in units of 10 hours (0.01). When the total time exceeds 99,990*2 hours, the count stops and the display remains at 99.99*1.
<i>5_07</i>	Cumulative run time of the cooling fan	Shows the content of the cumulative run time counter of the cooling fan. This counter does not work when the cooling fan ON/OFF control (function code H06) is enabled but the fan does not run. The display method is the same as for "Cumulative run time of electrolytic capacitor on the printed circuit board (<i>5_06</i>)" above. When the total time exceeds 99,990*2 hours, the count stops and the display remains at 99.99*1.
<i>5_08</i>	Number of startups	Shows the content of the cumulative counter of times the inverter is started up (i.e., the number of run commands issued). 1.000 indicates 1000 times. When any number from 0.001 to 9.999 is displayed, the counter increases by 0.001 per startup, and when any number from 10.00 to 65.53 is counted, the counter increases by 0.01 every 10 startups. When the counted number exceeds 65535, the counter will be reset to 0 and the count will start again.
<i>5_09</i>	Input watt-hour	Shows the input watt-hour of the inverter. Unit: 100 kWh (Display range: 0.001 to 9999) Depending on the value of integrated input watt-hour, the decimal point on the LED monitor shifts to show it within the LED monitors' resolution (e.g. the resolution varies between 0.001, 0.01, 0.1 or 1). To reset the integrated input watt-hour and its data, set function code E51 to "0.000." When the input watt-hour exceeds 1000000 kWh, it returns to "0."
<i>5_10</i>	Input watt-hour data	Shows the value expressed by "input watt-hour (kWh) × E51 (whose data range is 0.000 to 9999)." Unit: None. (Display range: 0.001 to 9999. The data cannot exceed 9999. (It will be fixed at 9999 once the calculated value exceeds 9999.)) Depending on the value of integrated input watt-hour data, the decimal point on the LED monitor shifts to show it within the LED monitors' resolution. To reset the integrated input watt-hour data, set function code E51 to "0.000."

*1 ROM version 1400 or later: 99.99, ROM version earlier than 1400: 65.53

*2 ROM version 1400 or later: 99,990, ROM version earlier than 1400: 65,535



The inverter's ROM version can be checked on Menu #5 "Maintenance Information" (*5_14*).

Table 3.18 Continued

LED Monitor shows:	Item	Description
5_11	No. of RS485 errors (standard)	Shows the total number of errors that have occurred in <i>standard</i> RS485 communication (via the RJ-45 connector as standard) since the power is turned on. Once the number of errors exceeds 9999, the count returns to 0.
5_12	Content of RS485 communications error (standard)	Shows the latest error that has occurred in <i>standard</i> RS485 communication in decimal format. For error contents, refer to the RS485 Communication User's Manual (MEH448a).
5_13	No. of option errors	Shows the total number of optional communications card errors since the power is turned on. Once the number of errors exceeds 9999, the count returns to 0.
5_14	Inverter's ROM version	Shows the inverter's ROM version as a 4-digit code.
5_15	Keypad's ROM version	Shows the keypad's ROM version as a 4-digit code.
5_17	No. of RS485 errors (option)	Shows the total number of errors that have occurred in <i>optional</i> RS485 communication since the power is turned on. Once the number of errors exceeds 9999, the count returns to 0.
5_18	Content of RS485 communications error (option)	Shows the latest error that has occurred in <i>optional</i> RS485 communication in decimal format. For error contents, refer to the RS485 Communication User's Manual (MEH448a).
5_19	Option's ROM version	Shows the option's ROM version as a 4-digit code.
5_23	Cumulative motor run time	Shows the content of the cumulative power-ON time counter of the motor. The display method is the same as for "Cumulative run time (5_27) above.

3.4.7 Reading alarm information – Menu #6 "Alarm Information"

Menu #6 "Alarm Information" shows the causes of the past 4 alarms in alarm code. Further, it is also possible to display alarm information that indicates the status of the inverter when the alarm occurred. Figure 3.11 shows the menu transition in Menu #6 "Alarm Information" and Table 3.19 lists the details of the alarm information.

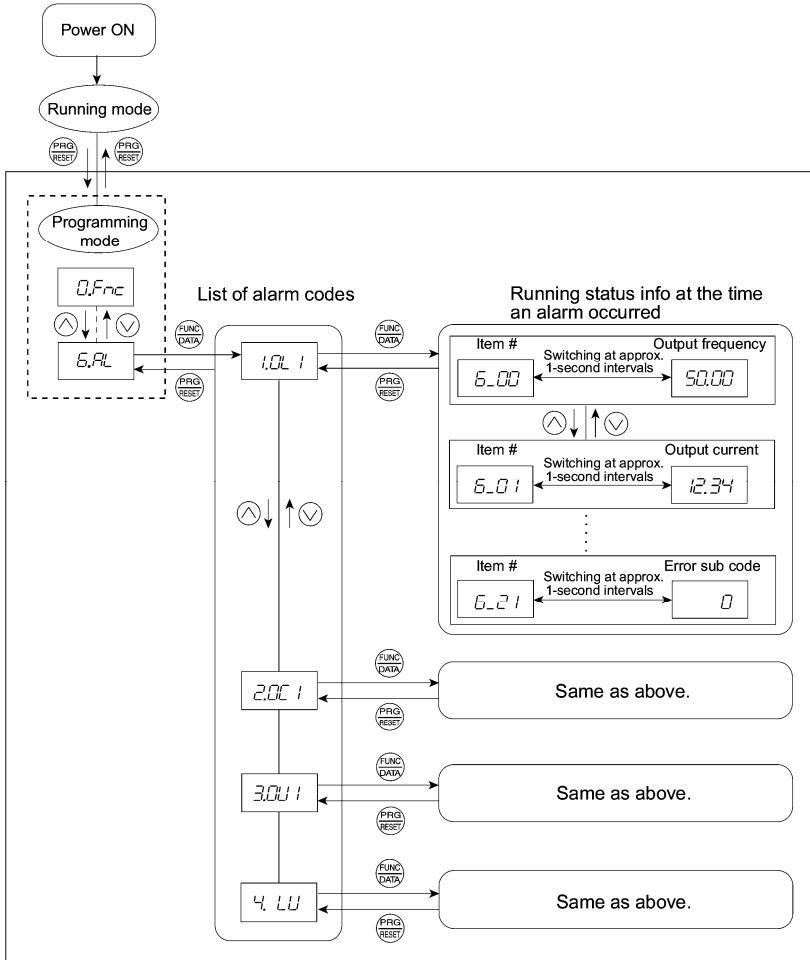

Figure 3.11 "Alarm Information" Menu Transition

Basic key operation

To view the alarm information, set function code E52 to "2: Full-menu mode" beforehand.











- (1) Turn the inverter on. It automatically enters Running mode. In that mode, press the  key to switch to Programming mode. The function selection menu appears.
- (2) Use the  and  keys to display "Alarm Information" (E_{FL}).
- (3) Press the  key to proceed to a list of alarm codes (e.g. 10L 1).
In the list of alarm codes, the alarm information for the last 4 alarms is saved as an alarm history.
- (4) Each time the  or  key is pressed, the last 4 alarms are displayed in order from the most recent one as 1, 2, 3 and 4.
- (5) While the alarm code is displayed, press the  key to have the corresponding alarm item number (e.g. E₀₀) and data (e.g. Output frequency) displayed alternately in intervals of approximately 1 second. You can also have the item number (e.g. E₀₁) and data (e.g. Output current) for any other item displayed using the  and  keys.
- (6) Press the  key to return to a list of alarm codes. Press the  key again to return to the menu.

Table 3.19 Alarm Information Displayed

LED monitor shows: (item No.)	Item displayed	Description
E ₀₀	Output frequency	Output frequency
E ₀₁	Output current	Output current
E ₀₂	Output voltage	Output voltage
E ₀₃	Calculated torque	Calculated motor output torque
E ₀₄	Reference frequency	Frequency specified by frequency command
E ₀₅	Rotational direction	This shows the rotational direction being output. F: forward; r: reverse; ---: stop
E ₀₆	Running status	This shows the running status in hexadecimal. Refer to "■ Displaying running status" in Section 3.4.4.
E ₀₇	Cumulative run time	Shows the content of the cumulative power-ON time counter of the inverter. Unit: thousands of hours. (Display range: 0.001 to 9.999, 10.00 to 65.53) When the total ON-time is less than 10000 hours (display: 0.001 to 9.999), data is shown in units of one hour (0.001). When the total time is 10000 hours or more (display: 10.00 to 65.53), it is shown in units of 10 hours (0.01). When the total time exceeds 65535 hours, the counter will be reset to 0 and the count will start again.
E ₀₈	No. of startups	Shows the content of the cumulative counter of times the inverter is started up (i.e., the number of run commands issued). 1.000 indicates 1000 times. When any number from 0.001 to 9.999 is displayed, the counter increases by 0.001 per startup, and when any number from 10.00 to 65.53 is counted, the counter increases by 0.01 every 10 startups. When the counted number exceeds 65535, the counter will be reset to 0 and the count will start again.
E ₀₉	DC link bus voltage	Shows the DC link bus voltage of the inverter main circuit. Unit: V (volts)
E ₁₀	Temperature inside the inverter	Shows the temperature inside the inverter when an alarm occurs. Unit: °C
E ₁₁	Max. temperature of heat sink	Shows the temperature of the heat sink. Unit: °C

Table 3.19 Continued

LED monitor shows: (item No.)	Item displayed	Description
E _L 12	Terminal I/O signal status (displayed with the ON/OFF of LED segments)	Shows the ON/OFF status of the digital I/O terminals. Refer to "■ Displaying control I/O signal terminals" in Section 3.4.5 "Checking I/O signal status " for details.
E _L 13	Terminal input signal status (in hexadecimal format)	
E _L 14	Terminal output signal status (in hexadecimal format)	
E _L 15	No. of consecutive occurrences	This is the number of times the same alarm occurs consecutively.
E _L 16	Overlapping alarm 1	Simultaneously occurring alarm codes (1) ("----" is displayed if no alarms have occurred.)
E _L 17	Overlapping alarm 2	Simultaneously occurring alarm codes (2) ("----" is displayed if no alarms have occurred.)
E _L 18	Terminal I/O signal status under communication control (displayed with the ON/OFF of LED segments)	Shows the ON/OFF status of the digital I/O terminals under RS485 communications control. Refer to "■ Displaying control I/O signal terminals under communications control" in Section 3.4.5 "Checking I/O signal status " for details.
E _L 19	Terminal input signal status under communication control (in hexadecimal format)	
E _L 20	Terminal output signal status under communication control (in hexadecimal format)	
E _L 21	Error sub code	Secondary error code for the alarm.

Note When the same alarm occurs repeatedly in succession, the alarm information for the first and last occurrences will be preserved and the information for other occurrences inbetween will be discarded. Only the number of consecutive occurrences will be updated.

3.4.8 Data copying information – Menu #7 "Data Copying"

Menu #7 "Data Copying" is used to read function code data out of an inverter for which function codes are already set up and then to write such function code data altogether into another inverter, or to verify the function code data stored in the keypad with the one registered in the inverter.

This subsection introduces restrictions and special notes concerning "Data Copying."

■ If data copying does not work

Check whether *E_{rr}* or *CPE_r* is blinking.

(1) If *E_{rr}* is blinking (a write error), any of the following problems has arisen:

- No data exists in the keypad memory. (No data read operation has been performed since shipment, or a data read operation has been aborted.)
- Data stored in the keypad memory contains any error.
- The models of copy source and destination inverters are different.
- A data write operation has been performed while the inverter is running.
- The copy destination inverter is data-protected. (function code F00=1)
- In the copy destination inverter, the "Enable write from keypad" command (WE-KP) is off.
- A Read data operation has been performed for the inverter whose data protection was enabled.

- (2) If *CPER* is blinking, any of the following problems has arisen:
- The function codes stored in the keypad and ones registered in the inverter are not compatible with each other. (Either of the two may have been revised or upgraded in a non-standard or incompatible manner. Contact your Fuji Electric representative.)

Figure 3.12 shows the menu transition in Menu #7 "Data Copying." The keypad can hold function codes for just one inverter.

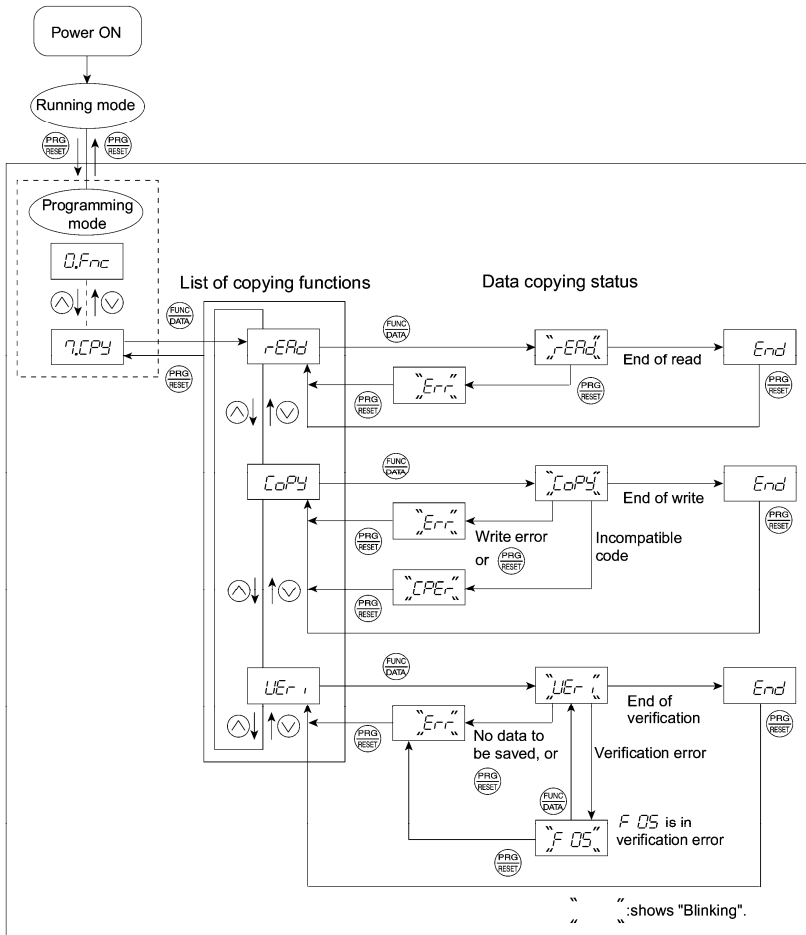

Figure 3.12 Menu Transition in Menu #7 "Data Copying"

Basic keying operation

- Turn the inverter on. It automatically enters Running mode. In that mode, press the key to switch to Programming mode. The function selection menu appears.
- Use the and keys to display "Data Copying" (*7.COPY*).
- Press the key to proceed to a list of copying functions (e.g. *rERd*).
- Use the and keys to select the desired function, then press the key to execute the function. (e.g. *rERd* will blink.)
- When the selected function has been executed, *End* appears. Press the key to return to the data copying function list. Press the key again to return to the menu.

■ Data protection

You can protect data saved in the keypad from unexpected modifications. Enabling the data protection that was disabled changes the display “r-Errd” on the Data copying function list to “P-df”, and disables to read data from the inverter.

To enable or disable the data protection, follow the next steps.

- (1) Select the data copy “COPY” in the Program mode menu.
- (2) Holding the  key down for 5 seconds or more alternates data protection status between enabled or disabled.

- Disabling the enabled Data protection

----- Hold  key down for 5 seconds. ----->

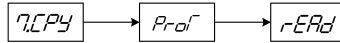

While running the Data copying (COPY) function, holding the  key down for 5 seconds displays “r-Errd” after appearing “P-df” temporarily to complete disabling the Data protection.

- Enabling the disabled Data protection

----- Hold  key down for 5 seconds. ----->

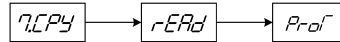







While running the Data copying (COPY) function, holding the  key down for 5 seconds displays “P-df” after appearing “r-Errd” temporarily to complete enabling the Data protection.

Table 3.20 below lists details of the Data copying function.

Table 3.20 List of Data Copying Functions



Display on LED Monitor	Function	Description
<i>r-ERd</i>	Read data	<p>Reads the function code data out of the inverter's memory and stores it into the keypad memory.</p> <p>Pressing the  key during a read operation (<i>r-ERd</i> blinking) immediately aborts the operation and displays <i>Err</i> (blinking). (*)</p> <p>If this happens, the entire contents of the memory of the keypad will be completely cleared.</p>
<i>COpy</i>	Write data	<p>Writes data stored in the keypad memory into the inverter's memory.</p> <p>If you press the  key during a write operation ("<i>COpy</i>" is blinking), the write operation that is under way will be aborted and "<i>Err</i>" will appear blinking(*). The contents (function code data,) of the inverter's memory remain partly old and partly updated. If this happens, do not operate the inverter; instead, perform initialization or rewrite the entire data.</p> <p>If any incompatible code is about to be written, <i>LPEn</i> appears blinking.</p> <p>If this function does not work, refer to "■ If data copying does not work" on page 3-29.</p>
<i>VER</i>	Verify data	<p>Verifies (collates) the data stored in the keypad memory with that in the inverter's memory.</p> <p>If any mismatch is detected, the verify operation will be aborted, with the function code in disagreement displayed blinking. Pressing the  key again causes the verification to continue from the next function code.</p> <p>Pressing the  key during a verify operation (<i>VER</i> , blinking) immediately aborts the operation and displays <i>Err</i> (blinking).(*)</p> <p><i>Err</i> appears blinking(*) also when the keypad does not contain any valid data.</p>
<i>PrOf</i>	Enable Data protection	<p>Enables the Data protection of data stored in the inverter's memory.</p> <p>In this state, you cannot read any data stored in the inverter's memory, but write data into the memory and verify data in the memory.</p> <p>Upon pressing the  key the inverter immediately displays "<i>Err</i>."</p>

(*)To get out of the error state indicated by a blinking "*Err*" or "*LPEn*," press the  key.



3.5 Alarm Mode

If an abnormal condition arises, the protective function is invoked to issue an alarm, and the inverter automatically enters Alarm mode. At the same time, an alarm code appears on the LED monitor.

■ Releasing the alarm and switching to Running mode

Remove the cause of the alarm and press the  key to release the alarm and return to Running mode. The alarm can be removed using the  key only when the alarm code is displayed.

■ Displaying the alarm history

It is possible to display the most recent 3 alarm codes in addition to the one currently displayed. Previous alarm codes can be displayed by pressing the  /  key while the current alarm code is displayed.

■ Displaying the status of inverter at the time of alarm

When the alarm code is displayed, you may check various running status information (output frequency and output current, etc.) by pressing the FUNC DATA key. The item number and data for each running information will be displayed alternately.

Further, you can view various pieces of information on the running status of the inverter using the STOP / PRG RESET key. The information displayed is the same as for Menu #6 "Alarm Information" in Programming mode. Refer to Table 3.19 in Section 3.4.7, "Reading alarm information."

Pressing the PRG RESET key while the running status information is displayed returns the display to the alarm codes.

Note When the running status information is displayed after removal of the alarm cause, pressing the PRG RESET key twice returns to the alarm code display and releases the inverter from the alarm state. This means that the motor starts running if a run command has been received by this time.

■ Switching to Programming mode

You can also switch to Programming mode by pressing STOP + PRG RESET keys simultaneously with the alarm displayed, and modify the function code data.

Figure 3.13 summarizes the possible transitions between different menu items.

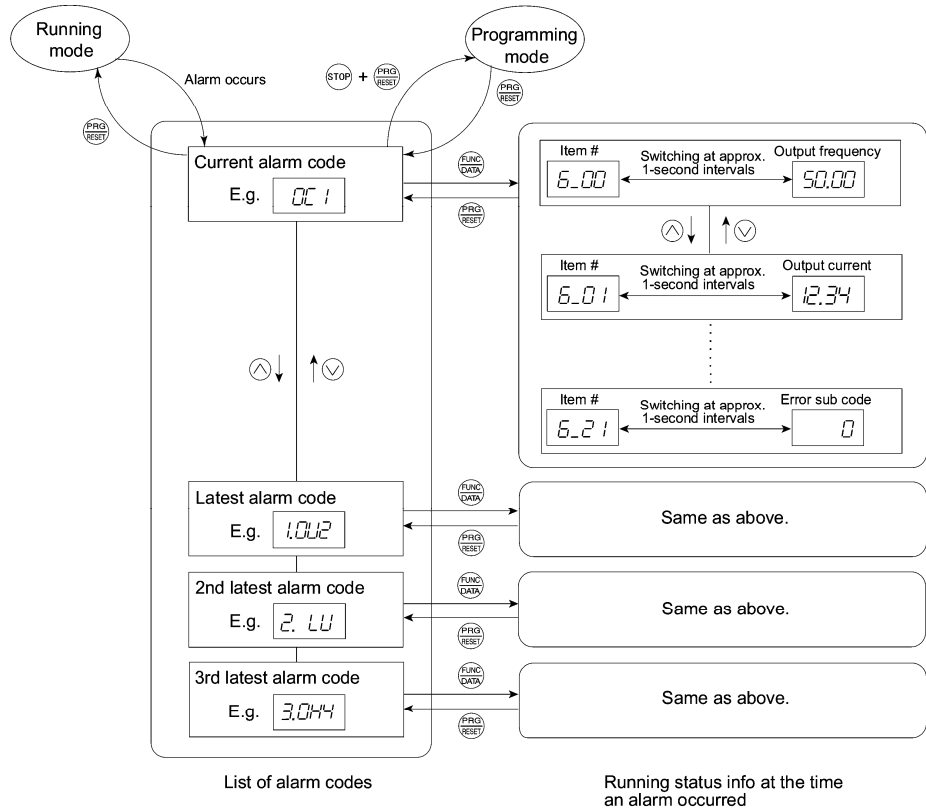

Figure 3.13 Menu Transition in Alarm Mode

Chapter 4 RUNNING THE MOTOR

4.1 Running the Motor for a Test

4.1.1 Inspection and preparation prior to powering on

Check the following prior to starting powering on.

- (1) Check if connection is correct.

Especially check if the power wires are connected to the inverter input terminals L1/R, L2/S and L3/T, and output terminals U, V and W respectively and that the grounding wires are connected to the ground electrodes correctly. Note that FRENIC-Eco series inverter is designed for three phase input and driving three phase motors.

WARNING

- Do not connect power supply wires to the inverter output terminals U, V, and W. Otherwise, the inverter may be broken if you turn the power ON.
- Be sure to connect the grounding wires of the inverter and the motor to the ground electrodes.

Otherwise, electric shock may occur.

- (2) Check for short circuits between terminals and exposed live parts and ground faults.
- (3) Check for loose terminals, connectors and screws.
- (4) Check if the motor is separated from mechanical equipment.
- (5) Turn the switches OFF so that the inverter does not start or operate erroneously at power-on.
- (6) Check if safety measures are taken against runaway of the system, e.g., a defense to protect people from unexpectedly approaching your power system.

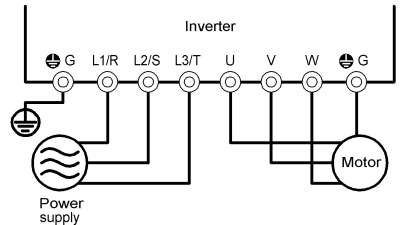

Figure 4.1 Connection of Main Circuit Terminals

4.1.2 Turning ON power and checking

WARNING

- Be sure to install the covers for both the main circuit terminal block, control circuit terminal block and the front cover if any before turning the power ON. Do not remove any cover while powering on.

- Do not operate switches with wet hands.

Otherwise electric shock could occur.

Turn the power ON and check the following points. This is a case when no function code data is changed from the factory setting.





- (1) Check if the LED monitor displays  (means that the frequency command is 0 Hz) that is blinking. (See Figure 4.2.) If the LED monitor displays numbers except  then press   keys to set  as the frequency command.
- (2) Check if a built-in cooling fan rotates. (When only the auxiliary power is fed while the main power is turned OFF, the cooling fan does not rotate. For the inverter of 1.5 kW or below no cooling fan is mounted.)



Figure 4.2 Display of the LED Monitor after Power-on

4.1.3 Preparation before running the motor for a test--Setting function code data

Before starting running the motor, set function code data specified in Table 4.1 to the motor ratings and your system design values. For the motor, check the rated values printed on the nameplate of the motor. For your system design values, ask system designers about them.

 For details about how to change function code data, refer to Chapter 3, Section 3.4.1 "Setting up function codes quickly." Refer to the function code H03 in Chapter 5 "FUNCTION CODES" for the factory default setting of motor parameters. If any of them is different from the default setting, change the function code data.

Table 4.1 Settings of Function Code Data before Driving the Motor for a Test

Function code	Name	Function code data	Factory setting		
			Asia (A)	Taiwan and Korea (K)	EU (E)
F 04	Base frequency	Motor ratings (printed on the nameplate of the motor)	60.0 (Hz)	50.0 (Hz)	50.0 (Hz)
F 05	Rated voltage (at base frequency)		220 (V)	200 (V)	-
			380 (V)	400 (V)	400 (V)
P 02	Motor parameter (Rated capacity)		Applicable motor rated capacity		
P 03	Motor parameter (Rated current)		Rated current of applicable motor		
P 99	Motor Selection		0: Characteristic of motor, 0 (Fuji standard 8-series motors)		
F 03	Maximum frequency	System design values * For a test-driving of the motor, increase values so that they are longer than your system design values. If the set time is short, the inverter may not start running the motor.	60.0 (Hz)	60.0 (Hz)	50.0 (Hz)
F 07	Acceleration time 1*		20.0 (s)		
F 08	Deceleration time 1*		20.0 (s)		

Tip

In any of the following cases, the default settings may not produce the best results for auto torque boost, torque calculation monitoring, or auto energy saving, since the standard settings of motor parameters for Fuji motors are not applicable. Tune the motor parameters according to the procedure set forth below.

- The motor to be driven is not a Fuji product or is a non-standard product.
- The cabling between the motor and the inverter is long.
- A reactor is inserted between the motor and the inverter.

<Tuning procedure>

1) Preparation

Referring to the rating plate on the motor, set the following function codes to their nominal ratings:

- F04: Base frequency
- F05: Rated voltage (at Base frequency)
- P02: Rated capacity
- P03: Rated current

2) Selection of Tuning Process

Check the situation of the machine system and choose between "Tuning while the motor is stopped (P04 = 1)" and "Tuning while the motor is running (P04 = 2)." In the case of "Tuning while the motor is running (P04 = 2)," also adjust the acceleration and deceleration times (F07 and F08) and set the rotation direction properly so that it matches the actual rotation direction of the machine system.



Data for P04	Motor parameters subject to Tuning:	Action	Choose the process when:
1	Primary resistance (%R1) Leakage reactance (%X)	Measure %R1 and %X while the motor is stopped.	The motor cannot be rotated, or more than 50% of the rated load would be applied on the motor if rotated.
2	Primary resistance (%R1) Leakage reactance (%X) No-load current	Measure %R1 and %X while the motor is stopped, and later no-load current while the motor is running. (At 50% of the Base frequency).	Even if the motor is rotated, it is safe and the load applied on the motor would be no more than 50% of the rating. (If you do the tuning with no load, you will get the highest precision.)

Upon completion of the tuning, the primary resistance %R1 will be automatically saved into P07, the leakage reactance %X into P08, and the no-load current into P06.

3) Preparation of Machine System

Perform appropriate preparations on the motor and its load, such as disengaging the coupling and deactivating the safety device.

4) Perform tuning

- ① Set function code P04 to "1" or "2" and press the  key. (The blinking of / or ε^2 on the LED monitor will slow down.)
- ② Enter a Run command for the rotation direction you have chosen. The factory default setting is "forward rotation upon pressing the  key on the keypad." To switch to reverse rotation, change the setting of function code F02.
- ③ The display of / or ε^2 stays lit, and tuning takes place while the motor is stopped. (Maximum tuning time: approximately 40 (s).)
- ④ If the function code P04 = 2, the motor is accelerated to approximately 50% of the base frequency and then tuning takes place. Upon completion of measurements, the motor will coast-to-stop. (Estimated tuning time: Acceleration time + 10 (s) + Deceleration time)
- ⑤ If the terminal signal (FWD) or (REV) is selected as the Run command (F02 = 1), ε_{REV} will appear upon completion of the measurements.
- ⑥ The Run command is turned OFF and the tuning completes, with the next function code $P05$ displayed on the keypad (the Run command given through the keypad or the communications link is automatically turned OFF).

■ Errors during tuning

Improper tuning would negatively affect the operation performance and, in the worst case, could even cause hunting or deteriorate precision. Therefore, if the inverter finds any abnormality in the results of the tuning or any error in the process of the tuning, it will display $\varepsilon-7$ and discard the tuning data.

Listed below are the abnormal or error conditions that can be recognized during tuning.

Abnormal/error condition	Description
Abnormal result of tuning	An inter-phase imbalance has been detected; Tuning has resulted in an abnormally high or low value of a parameter.
Abnormal output current	An abnormally high current has been caused during tuning.
Sequence error	During tuning, the Run command has been turned OFF, or forced STOP, coast-to-stop command (BX), dew condensation protection (DWP), or a similar abnormal command has been received.
Limitation exceeded	During tuning, a certain limitation has been reached or exceeded; The maximum output frequency or the peak limiter for output frequency has been reached or exceeded.
Other alarm condition	An undervoltage or an alarm has been occurred.

If any of these conditions has occurred, either eliminate the abnormal or error factor(s) and perform tuning again, or contact your Fuji Electric representative.

 **Note** If a filter other than Fuji optional output filter (OFL-□□□-4A) is connected to the inverter's output (secondary) circuit, the result of tuning can be unpredictable. When you replace an inverter, take note of the old inverter's settings for the primary resistance %R1, the leakage reactance %X, and the no-load current, and set those values to the new inverter's function codes.

4.1.4 Test run

WARNING

If the user set the function codes wrongly or without completely understanding this Instruction Manual and the FRENIC-Eco User's Manual (MEH456), the motor may rotate with a torque or at a speed not permitted for the machine.





Accident or injury may result.

Follow the descriptions of the previous Section 4.1.1, "Inspection and preparation prior to powering on" to Section 4.1.3, "Preparation before running the motor for a test," and begin test-driving of the motor.

CAUTION



If any abnormality is found to the inverter or motor, immediately stop operation and determine the cause referring to Chapter 6, "TROUBLESHOOTING."

----- Procedure for Test Run -----

- (1) Turn the power ON and check that the LED monitor blinks while indicating the  Hz frequency.
- (2) Set the frequency to a low frequency such as 5 Hz, using  /  keys. (Check that frequency command blinks on the LED monitor.)
- (3) Press the  key to start running the motor in the forward direction. (Check that the frequency command is displayed on the LED monitor correctly.)
- (4) To stop the motor, press the .

<Check the following points>

- Check if the direction of rotation is forward.
- Check for smooth rotation without motor humming or excessive vibration.
- Check for smooth acceleration and deceleration.

When no abnormality is found, press the  key again to start driving the motor, and increase the frequency command using  /  keys. Check the above points for the test-driving of the motor.

4.2 Operation

After confirming ordinary operation by performing a test run, make mechanical connections (connections of the machine system) and electrical connections (wiring and cabling), and set the necessary parameters properly before starting a production run.

 **Note** Depending on the conditions of the production run, further adjustments can be required, such as adjustments of torque boost (F09), acceleration time (F07), and deceleration time (F08). Make sure to set relevant function codes properly.

Chapter 5 FUNCTION CODES

5.1 Function Code Tables

Function codes enable the FRENIC-Eco series of inverters to be set up to match your system requirements.









Each function code consists of a 3-letter alphanumeric string. The first letter is an alphabet that identifies its group and the following two letters are numerals that identify each individual code in the group. The function codes are classified into eight groups: Fundamental Functions (F codes), Extension Terminal Functions (E codes), Control Functions of Frequency (C codes), Motor Parameters (P codes), High Performance Functions (H codes), Application Functions (J codes), Link Function (y codes) and Option Function (o codes). To determine the property of each function code, set data to the function code.

This manual does not contain the descriptions of Option Function (o codes). For Option Function (o codes), refer to the instruction manual for each option.

The following descriptions supplement those given in the function code tables on page 5-3 and subsequent pages.

■ Changing, validating, and saving function code data when the inverter is running

Function codes are indicated by the following based on whether they can be changed or not when the inverter is running:

Notation	Change when running	Validating and saving function code data
Y*	Possible	If the data of the codes marked with Y* is changed with  and  keys, the change will immediately take effect; however, the change is not saved into the inverter's memory. To save the change, press the  key. If you press the  key without pressing the  key to exit the current state, then the changed data will be discarded and the previous data will take effect for the inverter operation.
Y	Possible	Even if the data of the codes marked with Y is changed with  and  keys, the change will not take effect. Pressing the  key will make the change take effect and save it into the inverter's memory.
N	Impossible	—

■ Copying data

The keypad is capable of copying of the function code data stored in the inverter's memory into the keypad's memory (refer to Menu #7 "Data copying" in Programming mode). With this feature, you can easily transfer the data saved in a source inverter to other destination inverters.

If the specifications of the source and destination inverters differ, some code data may not be copied to ensure safe operation of your power system. Whether data will be copied or not is detailed with the following symbols in the "Data copying" column of the function code tables given below.

Y: Will be copied unconditionally.

Y1: Will not be copied if the rated capacity differs from the source inverter.

Y2: Will not be copied if the rated input voltage differs from the source inverter.

N: Will not be copied. (The function code marked with "N" is not subject to the Verify operation, either.)

If necessary, set up uncopied code data manually and individually.



For details of how to set up or edit function codes, refer to Chapter 3 "OPERATION USING THE KEYPAD."



If you are using the multi-function keypad (option), refer to the Multi-function Keypad Instruction Manual (INR-SI47-0890-E) for details.

■ Using negative logic for programmable I/O terminals

The negative logic signaling system can be used for the digital input and output terminals by setting the function code data specifying the properties for those terminals. Negative logic refers to the inverted ON/OFF (logical value 1 (true)/0 (false)) state of input or output signal. An ON-active signal (the function takes effect if the terminal is short-circuited.) in the normal logic system is functionally equivalent to OFF-active signal (the function takes effect if the terminal is opened.) in the negative logic system. An ON-active signal can be switched to OFF-active signal, and vice versa, with the function code data setting.

To set the negative logic system for an I/O signal terminal, enter data of 1000s (by adding 1000 to the data for the normal logic) in the corresponding function code and then press the  key.

The table below shows that the coast-to-stop command (BX) is assigned to the terminal [X1] using the function code E01.

Function code data	Description
7	If (BX) is ON, the inverter coast-to-stops the motor.
1007	If (BX) is OFF, the inverter coast-to-stops the motor

The following tables list the function codes available for the FRENIC-Eco series of inverters

 If you find any [-] (not available here) mark in the related page column of the function code tables, refer to FRENIC-Eco User's Manual (MEH456) for details.

F codes: Fundamental Functions

Code	Name	Data setting range	Increment	Unit	Change when running	Data copying	Default setting	Refer to page:
F00	Data Protection	0: Disable data protection (Function code data can be edited.) 1: Enable data protection	—	—	Y	Y	0	5-22
F01	Frequency Command 1	0: Enable  /  keys on keypad 1: Enable voltage input to terminal [12] (0 to 10 VDC) 2: Enable current input to terminal [C1] (4 to 20 mA DC) 3: Enable sum of voltage and current inputs to terminals [12] and [C1] 5: Enable voltage input to terminal [V2] (0 to 10 VDC) 7: Enable terminal command (UP) / (DOWN) control	—	—	N	Y	0	
F02	Run Command	0: Enable  /  keys on keypad (Motor rotational direction from digital terminals [FWD] / [REV]) 1: Enable terminal command (FWD) or (REV) 2: Enable  /  keys on keypad (forward) 3: Enable  /  keys on keypad (reverse)	—	—	N	Y	2	5-23
F03	Maximum Frequency	25.0 to 120.0	0.1	Hz	N	Y	Refer to table below.	5-24
F04	Base Frequency	25.0 to 120.0	0.1	Hz	N	Y	Refer to table below.	
F05	Rated Voltage at Base Frequency	0: Output a voltage in proportion to input voltage 80 to 240: Output a voltage AVR-controlled (for 200 V series) 160 to 500: Output a voltage AVR-controlled (for 400 V series)	1	V	N	Y2	Refer to table below.	
F07	Acceleration Time 1	0.00 to 3600 Note: Entering 0.00 cancels the acceleration time, requiring external soft-start.	0.01	s	Y	Y	20.0	5-27
F08	Deceleration Time 1	0.00 to 3600 Note: Entering 0.00 cancels the deceleration time, requiring external soft-start.	0.01	s	Y	Y	20.0	

The shaded function codes () are applicable to the quick setup.

■ Factory defaults (F03, F04 and F05)

Function code	Factory defaults				
	Asia (A)		Taiwan and Korea (K)		EU (E)
	200 V series	400 V series	200 V series	400 V series	400 V series
F03	60 Hz	50 Hz *1	60 Hz	60 Hz	50 Hz
F04	60 Hz	50 Hz *1	50 Hz	50 Hz	50 Hz
F05	220 V	415 V *2	200 V	400 V	400 V

*1 The factory default of F03/F04 is "50.0 Hz." If initialized by H03, the data reverts to "60.0 Hz."

*2 The factory default of F05 is "415 V." If initialized by H03, the data reverts to "380 V."

(F code continued)

Code	Name	Data setting range	Increment	Unit	Change when running	Data copying	Default setting	Refer to page:
F09	Torque Boost	0.0 to 20.0 (Percentage of the rated voltage at base frequency (F05)) Note: This setting is effective when F37 = 0, 1, 3, or 4.	0.1	%	Y	Y	Refer to table below.	5-27
F10	Electronic Thermal Overload Protection for Motor (Select motor characteristics)	1: For general-purpose motors with built-in self-cooling fan 2: For inverter-driven motors or high-speed motors with forced-ventilation fan	—	—	Y	Y	1	5-30
F11	(Overload detection level)	0.00: Disable 1 to 135% of the rated current (allowable continuous drive current) of the motor	0.01	A	Y	Y1 Y2	100% of the motor rated current	
F12	(Thermal time constant)	0.5 to 75.0	0.1	min	Y	Y	5 (22 kW or below) 10 (30 kW or above)	
F14	Restart Mode after Momentary Power Failure (Mode selection)	0: Disable restart (Trip immediately) 1: Disable restart (Trip after a recovery from power failure) 3: Enable restart (Continue to run, for heavy inertia or general loads) 4: Enable restart (Restart at the frequency at which the power failure occurred, for general loads) 5: Enable restart (Restart at the starting frequency, for low-inertia load)	—	—	Y	Y	1 (0) *2	5-33
F15	Frequency Limiter (High)	0.0 to 120.0	0.1	Hz	Y	Y	70.0	5-38
F16	(Low)	0.0 to 120.0	0.1	Hz	Y	Y	0.0	
F18	Bias (Frequency command 1)	-100.00 to 100.00 *1	0.01	%	Y*	Y	0.00	5-39
F20	DC Braking (Braking start frequency)	0.0 to 60.0	0.1	Hz	Y	Y	0.0	5-40
F21	(Braking level)	0 to 60 (Rated output current of the inverter interpreted as 100%)	1	%	Y	Y	0	
F22	(Braking time)	0.00: Disable 0.01 to 30.00	0.01	s	Y	Y	0.00	
F23	Starting Frequency	0.1 to 60.0	0.1	Hz	Y	Y	0.5	5-41
F25	Stop Frequency	0.1 to 60.0	0.1	Hz	Y	Y	0.2	

The shaded function codes () are applicable to the quick setup.

*1 When you make settings from the keypad, the incremental unit is restricted by the number of digits that the LED monitor can display.

(Example) If the setting range is from -200.00 to 200.00, the incremental unit is:

"1" for -200 to -100, "0.1" for -99.9 to -10.0 and for 100.0 to 200.0, and "0.01" for -9.99 to -0.01 and for 0.00 to 99.99.

*2 Values in parentheses () in the above table denote default settings for the EU version.

■ Torque boost per motor capacity by factory defaults (F09)

Motor rating (kW)	Torque boost (%)	Motor rating (kW)	Torque boost (%)
0.1	8.4	5.5	3.4
0.2	8.4	7.5	2.7
0.4	7.1	11	2.1
0.75	6.5	15	1.6
1.5	4.9	18.5	1.3
2.2	4.5	22	1.1
3.7	4.1	30 to 220	0.0

(F code continued)

Code	Name	Data setting range	Increment	Unit	Change when running	Data copying	Default setting	Refer to page:
F26	Motor Sound (Carrier frequency)	0.75 to 15 (22 kW or below) *1 0.75 to 10 (30 to 75 kW) 0.75 to 6 (90 kW or above)	1	kHz	Y	Y	Refer to table below.	5-41
F27	(Tone)	0: Level 0 (Inactive) 1: Level 1 2: Level 2 3: Level 3	—	—	Y	Y	0	
F29	Analog Output [FMA] (Mode selection)	0: Output in voltage (0 to 10 VDC) 1: Output in current (4 to 20 mA DC)	—	—	Y	Y	0	5-42
F30	(Output adjustment)	0 to 200	1	%	Y*	Y	100	
F31	Analog Output [FMA] (Function)	Select a function to be monitored from the followings. 0: Output frequency 2: Output current 3: Output voltage 4: Output torque 5: Load factor 6: Input power 7: PID feedback value (PV) 9: DC link bus voltage 10: Universal AO 13: Motor output 14: Test analog output 15: PID process command (SV) 16: PID process output (MV)	—	—	Y	Y	0	5-44
F33	Pulse Output [FMP] *2 (Pulse rate)	25 to 6000 (Pulse rate at 100% output)	1	p/s	Y*	Y	1440	
F34	(Duty)	0: Output pulse rate (Fixed at 50% duty) 1 to 200: Voltage output adjustment (Pulse rate is fixed at 2000 p/s. Adjust the maximum pulse duty.)	1	%	Y*	Y	0	
F35	(Function)	Select a function to be monitored from the followings. 0: Output frequency 2: Output current 3: Output voltage 4: Output torque 5: Load factor 6: Input power 7: PID feedback value (PV) 9: DC link bus voltage 10: Universal AO 13: Motor output 14: Test analog output 15: PID process command (SV) 16: PID process output (MV)	—	—	Y	Y	0	

The shaded function codes () are applicable to the quick setup.

*1 If the carrier frequency is set at 1 kHz or below, estimate the maximum motor output torque at 80% or less of the rated motor torque.

*2 The control printed circuit board (the control PCB) is equipped with either a screw terminal base or Europe type terminal block, supporting [FMP] or [FMI], respectively. The [FMP] enables F33 to F35, but the [FMI] enables only F34 and F35 so that F33 will not appear.

■ Factory defaults (F26)

Inverter rated capacity (kW)	Asia (A)	Taiwan and Korea (K)	EU (E)
22 kW or below	2	2	15
30 to 75 kW			10
90 kW or above			6

(F code continued)

Code	Name	Data setting range	Increment	Unit	Change when running	Data copying	Default setting	Refer to page:
F34	Terminal [FMI] *1 (Duty)	0 to 200: Voltage output adjustment	1	%	Y*	Y	100	5-45
F35	(Function)	Select a function to be monitored from the followings. 0: Output frequency 2: Output current 3: Output voltage 4: Output torque 5: Load factor 6: Input power 7: PID feedback value (PV) 9: DC link bus voltage 10: Universal AO 13: Motor output 14: Test analog output 15: PID process command (SV) 16: PID process output (MV)	—	—	Y	Y	0	
F37	Load Selection/ Auto Torque Boost / Auto Energy Saving Operation	0: Variable torque load increasing in proportion to square of speed 1: Variable torque load increasing in proportion to square of speed (Higher startup torque required) 2: Auto-torque boost 3: Auto-energy saving operation (Variable torque load increasing in proportion to square of speed) 4: Auto-energy saving operation (Variable torque load increasing in proportion to square of speed (Higher startup torque required)) Note: Apply this setting to a load with short acceleration time. 5: Auto-energy saving operation (Auto torque boost) Note: Apply this setting to a load with long acceleration time.	—	—	N	Y	1	5-27
F43	Current Limiter (Mode selection)	0: Disable (No current limiter works.) 1: Enable at constant speed (Disabled during acceleration and deceleration) 2: Enable during acceleration and at constant speed	—	—	Y	Y	0	—
F44	(Level)	20 to 120 (The data is interpreted as the rated output current of the inverter for 100%.)	1	%	Y	Y	110	

*1 The control PCB is equipped with either a screw terminal base or Europe type terminal block, supporting [FMP] or [FMI], respectively. The [FMP] enables F33 to F35, but the [FMI] enables only F34 and F35 so that F33 will not appear.

E codes: Extension Terminal Functions

Code	Name	Data setting range	Increment	Unit	Change when running	Data copying	Default setting	Refer to page:
E01	Command Assignment to:	Selecting function code data assigns the corresponding function to terminals [X1] to [X5] as listed below.	—	—	N	Y	6	5-45
E02	[X2]	Setting the value of 1000s in parentheses () shown below assigns a negative logic input to a terminal.	—	—	N	Y	7	
E03	[X3]	0 (1000): } (SS1)	—	—	N	Y	8	5-45
E04	[X4]	1 (1001): } Select multistep frequency (SS2) 2 (1002): } (SS4)	—	—	N	Y	11	
E05	[X5]	6 (1006): Enable 3-wire operation (HLD) 7 (1007): Coast to a stop (BX) 8 (1008): Reset alarm (RST) 9 (1009): Enable external alarm trip (THR) 11 (1011): Switch frequency command 2/1 (Hz2/Hz1) 13: Enable DC brake (DCBRK) 15: Switch to commercial power (50 Hz) (SW50) 16: Switch to commercial power (60 Hz) (SW60) 17 (1017): UP (Increase output frequency) (UP) 18 (1018): DOWN (Decrease output frequency) (DOWN) 19 (1019): Enable write from keypad (Data changeable) (WE-KP) 20 (1020): Cancel PID control (HzPID) 21 (1021): Switch normal/inverse operation (IVS) 22 (1022): Interlock (IL) 24 (1024): Enable communications link via RS485 or field bus (option) (LE) 25 (1025): Universal DI (U-DI) 26 (1026): Select starting characteristics (STM) 30 (1030): Force to stop (STOP) 33 (1033): Reset PID integral and differential components (PID-RST) 34 (1034): Hold PID integral component (PID-HLD) 35 (1035): Select local (keypad) operation (LOC) 38 (1038): Enable to run (RE) 39: Protect motor from dew condensation (DWP) 40: Enable integrated sequence to switch to commercial power (50 Hz) (ISW50) 41: Enable integrated sequence to switch to commercial power (60 Hz) (ISW60) 50 (1050): Clear periodic switching time (MCLR) 51 (1051): Enable pump drive (motor 1) (MEN1) 52 (1052): Enable pump drive (motor 2) (MEN2) 53 (1053): Enable pump drive (motor 3) (MEN3) 54 (1054): Enable pump drive (motor 4) (MEN4) 87 (1087): Switch run command 2/1 (FR2/FR1) 88: Run forward 2 (FWD2) 89: Run reverse 2 (REV2) Note: In the case of (THR) and (STOP), data (1009) and (1030) are for normal logic, and "9" and "30" are for negative logic, respectively.	—	—	N	Y	35	

(E code continued)

Code	Name	Data setting range	Increment	Unit	Change when running	Data copying	Default setting	Refer to page:
E20	Signal Assignment to: (Transistor signal)	Selecting function code data assigns the corresponding function to terminals [Y1] to [Y3], [Y 5A/C], and [30A/B/C] as listed below.	—	—	N	Y	0	5-52
E21	[Y1]		—	—	N	Y	1	
E22	[Y2]	Setting the value of 1000s in parentheses () shown below assigns a negative logic input to a terminal.	—	—	N	Y	2	
E24	(Relay contact signal) [Y5A/C]	0 (1000): Inverter running (RUN) 1 (1001): Frequency arrival signal (FAR) 2 (1002): Frequency detected (FDT)	—	—	N	Y	15 (10)*1	5-52
E27	[30A/B/C]	3 (1003): Undervoltage detected (Inverter stopped) (LU) 5 (1005): Inverter output limiting (IOL) 6 (1006): Auto-restarting after momentary power failure (IPF) 7 (1007): Motor overload early warning (OL) 10 (1010): Inverter ready to run (RDY) 11: Switch motor drive source between commercial power and inverter output (For MC on commercial line) (SW88) 12: Switch motor drive source between commercial power and inverter output (For primary side) (SW52-2) 13: Switch motor drive source between commercial power and inverter output (For secondary side) (SW52-1) 15 (1015): Select AX terminal function (For MC on primary side) (AX) 25 (1025): Cooling fan in operation (FAN) 26 (1026): Auto-resetting (TRY) 27 (1027): Universal DO (U-DO) 28 (1028): Heat sink overheat early warning (OH) 30 (1030): Service life alarm (LIFE) 33 (1033): Command loss detected (REF OFF) 35 (1035): Inverter output on (RUN2) 36 (1036): Overload prevention control (OLP) 37 (1037): Current detected (ID) 42 (1042): PID alarm (PID-ALM) 43 (1043): Under PID control (PID-CTL) 44 (1044): Motor stopping due to slow flow rate under PID control (PID-STP) 45 (1045): Low output torque detected (U-TL) 54 (1054): Inverter in remote operation (RMT) 55 (1055): Run command activated (AX2) 56 (1056): Motor overheat detected (PTC) (THM) 59 (1059): Terminal [C1] wire break *2 (C1 OFF) 60 (1060): Mount motor 1, inverter-driven (M1_I) 61 (1061): Mount motor 1, commercial-power-driven (M1_L) 62 (1062): Mount motor 2, inverter-driven (M2_I) 63 (1063): Mount motor 2, commercial-power-driven (M2_L) 64 (1064): Mount motor 3, inverter-driven (M3_I) 65 (1065): Mount motor 3, commercial-power-driven (M3_L) 67 (1067): Mount motor 4, commercial-power-driven (M4_L) 68 (1068): Periodic switching early warning (MCHG) 69 (1069): Pump control limit signal (MLIM) 99 (1099): Alarm output (for any alarm) (ALM)	—	—	N	Y	99	

*1 Values in parentheses () in the above table denote default settings for the EU version.

*2 Available for inverters having a ROM version 1400 or later.

(E code continued)

Code	Name	Data setting range	Increment	Unit	Change when running	Data copying	Default setting	Refer to page:
E31	Frequency Detection (FDT) (Detection level)	0.0 to 120.0	0.1	Hz	Y	Y	Refer to table below.	5-58
E32	(Hysteresis width) ^{*3}	0.0 to 120.0	0.1	Hz	Y	Y	1.0	
E34	Overload Early Warning /Current Detection (Level)	0: (Disable) Current value of 1 to 150% of the inverter rated current	0.01	A	Y	Y1 Y2	100% of the motor rated current	5-58
E35	(Timer)	0.01 to 600.00 *1	0.01	s	Y	Y	10.00	
E40	PID Display Coefficient A	-999 to 0.00 to 999 *1	0.01	—	Y	Y	100	—
E41	PID Display Coefficient B	-999 to 0.00 to 999 *1	0.01	—	Y	Y	0.00	
E43	LED Monitor (Item selection)	0: Speed monitor (Select by E48.) 3: Output current 4: Output voltage 8: Calculated torque 9: Input power 10: PID process command (Final) 12: PID feedback value 14: PID output 15: Load factor 16: Motor output 17: Analog input	—	—	Y	Y	0	
E45	LCD Monitor *2 (Item selection)	0: Running status, rotational direction and operation guide 1: Bar charts for output frequency, current and calculated torque	—	—	Y	Y	0	
E46	(Language selection)	0: Japanese 1: English 2: German 3: French 4: Spanish 5: Italian	—	—	Y	Y	1	
E47	(Contrast control)	0 (Low) to 10 (High)	1	—	Y	Y	5	
E48	LED Monitor (Speed monitor item)	0: Output frequency 3: Motor speed in r/min 4: Load shaft speed in r/min 7: Display speed in %	—	—	Y	Y	0	
E50	Coefficient for Speed Indication	0.01 to 200.00 *1	0.01	—	Y	Y	30.00	
E51	Display Coefficient for Input Watt-hour Data	0.000: (Cancel/reset) 0.001 to 9999	0.001	—	Y	Y	0.010	5-59
E52	Keypad (Menu display mode)	0: Function code data editing mode (Menus #0, #1 and #7) 1: Function code data check mode (Menus #2 and #7) 2: Full-menu mode (Menus #0 through #7)	—	—	Y	Y	0	—

The shaded function codes () are applicable to the quick setup.

*1 When you make settings from the keypad, the incremental unit is restricted by the number of digits that the LED monitor can display.

(Example) If the setting range is from -200.00 to 200.00, the incremental unit is:

"1" for -200 to -100, "0.1" for -99.9 to -10.0 and for 100.0 to 200.0, and "0.01" for -9.99 to -0.01 and for 0.00 to 99.99.

*2 LCD monitor settings are applicable only to the inverter equipped with a multi-function keypad.

*3 Available for inverters having a ROM version 1400 or later.

■ Factory defaults (E31)

Function code	Asia (A)		Taiwan and Korea (K)		EU (E)
	200 V series	400 V series	200 V series	400 V series	400 V series
E31	60 Hz	50 Hz *4	60 Hz		50 Hz

*4 The factory default of E31 is "50.0 Hz." If initialized by H03, the data reverts to "60.0 Hz."

(E code continued)

Code	Name	Data setting range	Increment	Unit	Change when running	Data copying	Default setting	Refer to page:
E61	Analog Input for (Extension function selection)	Selecting function code data assigns the corresponding function to terminals [12], [C1] and [V2] as listed below. 0: None 1: Auxiliary frequency command 1 2: Auxiliary frequency command 2	—	—	N	Y	0	—
E62	[12]	3: PID process command 1 5: PID feedback value	—	—	N	Y	0	
E63	[C1]	20: Analog input monitor	—	—	N	Y	0	
	[V2]							
E64	Saving Digital Reference Frequency	0: Auto saving (at the time of main power turned off) 1: Saving by pressing  key	—	—	Y	Y	0	
E65	Command Loss Detection (Level)	0: Decelerate to stop 20 to 120 999: Disable	1	%	Y	Y	999	5-59
E80	Detect Low Torque (Detection level)	0 to 150	1	%	Y	Y	20	5-60
E81	(Timer)	0.01 to 600.00 *1	0.01	s	Y	Y	20.00	

*1 When you make settings from the keypad, the incremental unit is restricted by the number of digits that the LED monitor can display.



(Example) If the setting range is from -200.00 to 200.00, the incremental unit is:

"1" for -200 to -100, "0.1" for -99.9 to -10.0 and for 100.0 to 200.0, and "0.01" for -9.99 to -0.01 and for 0.00 to 99.99.

(E code continued)

Code	Name	Data setting range	Incre- ment	Unit	Change when running	Data copying	Default setting	Refer to page:
E98	Command Assignment to: [FWD]	Selecting function code data assigns the corresponding function to terminals [FWD] and [REV] as listed below.	—	—	N	Y	98	5-45
E99	[REV]	Setting the value of 1000s in parentheses () shown below assigns a negative logic input to a terminal. 0 (1000): } (SS1) 1 (1001): } Select multistep frequency (SS2) 2 (1002): } (SS4) 6 (1006): Enable 3-wire operation (HLD) 7 (1007): Coast to a stop (BX) 8 (1008): Reset alarm (RST) 9 (1009): Enable external alarm trip (THR) 11 (1011): Switch frequency command 2/1 (Hz2/Hz1) 13: Enable DC brake (DCBRK) 15: Switch to commercial power (50 Hz) (SW50) 16: Switch to commercial power (60 Hz) (SW60) 17 (1017): UP (Increase output frequency) (UP) 18 (1018): DOWN (Decrease output frequency) (DOWN) 19 (1019): Enable write from keypad (Data changeable) 20 (1020): Cancel PID control (Hz/PID) 21 (1021): Switch normal/inverse operation (IVS) 22 (1022): Interlock (IL) 24 (1024): Enable communications link via RS485 or field bus (option) (LE) 25 (1025): Universal DI (U-DI) 26 (1026): Select starting characteristics (STM) 30 (1030): Force to stop (STOP) 33 (1033): Reset PID integral and differential components (PID RST) 34 (1034): Hold PID integral component (PID-HLD) 35 (1035): Select local (keypad) operation (LOC) 38 (1038): Enable to run (RE) 39: Protect motor from dew condensation (DWP) 40: Enable integrated sequence to switch to commercial power (50 Hz) (ISW50) 41: Enable integrated sequence to switch to commercial power (60 Hz) (ISW60) 50 (1050): Clear periodic switching time (MCLR) 51 (1051): Enable pump drive (motor 1) (MEN1) 52 (1052): Enable pump drive (motor 2) (MEN2) 53 (1053): Enable pump drive (motor 3) (MEN3) 54 (1054): Enable pump drive (motor 4) (MEN4) 87 (1087): Switch run command 2/1 (FR2/FR1) 88: Run forward 2 (FWD2) 89: Run reverse 2 (REV2) 98: Run forward (FWD) 99: Run reverse (REV) Note: In the case of (THR) and (STOP), data (1009) and (1030) are for normal logic, and "9" and "30" are for negative logic, respectively.	—	—	N	Y	99	

C codes: Control Functions of Frequency

Code	Name	Data setting range	Increment	Unit	Change when running	Data copying	Default setting	Refer to page:
C01	Jump Frequency 1	0.0 to 120.0	0.1	Hz	Y	Y	0.0	—
C02	2				Y	Y	0.0	
C03	3				Y	Y	0.0	
C04	(Band)	0.0 to 30.0	0.1	Hz	Y	Y	0.0	
C05	Multistep Frequency 1	0.00 to 120.00 *1	0.01	Hz	Y	Y	0.00	
C06	2				Y	Y	0.00	
C07	3				Y	Y	0.00	
C08	4				Y	Y	0.00	
C09	5				Y	Y	0.00	
C10	6				Y	Y	0.00	
C11	7				Y	Y	0.00	
C30	Frequency Command 2	0: Enable  /  keys on keypad 1: Enable voltage input to terminal [12] (0 to 10 VDC) 2: Enable current input to terminal [C1] (4 to 20 mA DC) 3: Enable sum of voltage and current inputs to terminals [12] and [C1] 5: Enable voltage input to terminal [V2] (0 to 10 VDC) 7: Enable terminal command (UP) / (DOWN) control	—	—	N	Y	2	5-22
C32	Analog Input Adjustment for [12] (Gain)	0.00 to 200.00 *1	0.01	%	Y*	Y	100.0	5-39
C33	(Filter time constant)	0.00 to 5.00	0.01	s	Y	Y	0.05	5-60
C34	(Gain reference point)	0.00 to 100.00 *1	0.01	%	Y*	Y	100.0	5-39
C37	Analog Input Adjustment for [C1] (Gain)	0.00 to 200.00 *1	0.01	%	Y*	Y	100.0	
C38	(Filter time constant)	0.00 to 5.00	0.01	s	Y	Y	0.05	5-60
C39	(Gain reference point)	0.00 to 100.00 *1	0.01	%	Y*	Y	100.0	5-39
C42	Analog Input Adjustment for [V2] (Gain)	0.00 to 200.00 *1	0.01	%	Y*	Y	100.0	
C43	(Filter time constant)	0.00 to 5.00	0.01	s	Y	Y	0.05	5-60
C44	(Gain reference point)	0.00 to 100.00 *1	0.01	%	Y*	Y	100.0	5-39
C50	Bias Reference Point (Frequency command 1)	0.00 to 100.0 *1	0.01	%	Y*	Y	0.00	
C51	Bias for PID command 1 (Bias value)	-100.0 to 100.00 *1	0.01	%	Y*	Y	0.00	—
C52	(Bias reference point)	0.00 to 100.00 *1	0.01	%	Y*	Y	0.00	
C53	Selection of Normal/ Inverse Operation (Frequency command 1)	0: Normal operation 1: Inverse operation	—	—	Y	Y	0	

*1 When you make settings from the keypad, the incremental unit is restricted by the number of digits that the LED monitor can display.

(Example) If the setting range is from -200.00 to 200.00, the incremental unit is:

"1" for -200 to -100, "0.1" for -99.9 to -10.0 and for 100.0 to 200.0, and "0.01" for -9.99 to -0.01 and for 0.00 to 99.99.

P codes: Motor Parameters

Code	Name	Data setting range	Increment	Unit	Change when running	Data copying	Default setting	Refer to page:
P01	Motor (No. of poles)	2 to 22	2	Pole	N	Y1 Y2	4	5-60
P02	(Rated capacity)	0.01 to 1000 (where, the data of function code P99 is 0, 3, or 4.) 0.01 to 1000 (where, the data of function code P99 is 1.)	0.01	kW HP	N	Y1 Y2	Rated capacity of motor	
P03	(Rated current)	0.00 to 2000	0.01	A	N	Y1 Y2	Rated current of Fuji standard motor	5-61
P04	(Auto-tuning)	0: Disable 1: Enable (Tune %R1 and %X while the motor is stopped.) 2: Enable (Tune %R1 and %X while the motor is stopped, and no-load current while running.)	—	—	N	N	0	
P06	(No-load current)	0.00 to 2000	0.01	A	N	Y1 Y2	Rated value of Fuji standard motor	5-62
P07	(%R1)	0.00 to 50.00	0.01	%	Y	Y1 Y2	Rated value of Fuji standard motor	
P08	(%X)	0.00 to 50.00	0.01	%	Y	Y1 Y2	Rated value of Fuji standard motor	
P99	Motor Selection	0: Characteristics of motor 0 (Fuji standard motors, 8-series) 1: Characteristics of motor 1 (HP-rated motors) 3: Characteristics of motor 3 (Fuji standard motors, 6-series) 4: Other motors	—	—	N	Y1 Y2	0	5-62

The shaded function codes () are applicable to the quick setup.

H codes: High Performance Functions

Code	Name	Data setting range	Increment	Unit	Change when running	Data copying	Default setting	Refer to page:
H03	Data Initialization	0: Disable initialization 1: Initialize all function code data to the factory defaults 2: Initialize motor parameters	—	—	N	N	0	5-62
H04	Auto-resetting (Times)	0: Disable 1 to 10	1	Times	Y	Y	0	5-67
H05	(Reset interval)	0.5 to 20.0	0.1	s	Y	Y	5.0	
H06	Cooling Fan ON/OFF Control	0: Disable (Always in operation) 1: Enable (ON/OFF controllable)	—	—	Y	Y	0	5-68
H07	Acceleration/Deceleration Pattern	0: Linear 1: S-curve (Weak) 2: S-curve (Strong) 3: Curvilinear	—	—	Y	Y	0	
H09	Select Starting Characteristics (Auto search for idling motor speed)	0: Disable 3: Enable (Follow Run command, either forward or reverse.) 4: Enable (Follow Run command, both forward and reverse.) 5: Enable (Follow Run command, inversely both forward and reverse.)	—	—	N	Y	0	5-69
H11	Deceleration Mode	0: Normal deceleration 1: Coast-to-stop	—	—	Y	Y	0	5-71
H12	Instantaneous Overcurrent Limiting	0: Disable 1: Enable	—	—	Y	Y	1	5-72
H13	Restart Mode after Momentary Power Failure (Restart time)	0.1 to 10.0	0.1	s	Y	Y1 Y2	Depending on the inverter capacity	5-33
H14	(Frequency fall rate)	0.00: Set deceleration time 0.01 to 100.00 999: Follow the current limit command	0.01	Hz/s	Y	Y	999	
H15	(Continuous running level)	200V series: 200 to 300 400V series: 400 to 600	1	V	Y	Y2	235 470	—
H16	(Allowable momentary power failure time)	0.0 to 30.0 999: The longest time automatically determined by the inverter	0.1	s	Y	Y	999	5-33
H17	Select Starting Characteristics (Frequency for idling motor speed)	0.0 to 120.0 999: Harmonize at the maximum frequency	0.1	Hz	Y	Y	999	5-69
H26	PTC Thermistor (Mode selection)	0: Disable 1: Enable (Upon detection of (PTC), the inverter immediately trips and stops with  displayed.) 2: Enable (Upon detection of (PTC), the inverter continues running while outputting alarm signal (THM).)	—	—	Y	Y	0	—
H27	(Level)	0.00 to 5.00	0.01	V	Y	Y	1.60	

(H code continued)

Code	Name	Data setting range	Increment	Unit	Change when running	Data copying	Default setting	Refer to page:
H30	Communications Link Function (Mode selection)	Frequency command Run command 0: F01/C30 F02 1: RS485 link F02 2: F01/C30 RS485 link 3: RS485 link RS485 link 4: RS485 link (Option) F02 5: RS485 link (Option) RS485 link 6: F01/C30 RS485 link (Option) 7: RS485 link RS485 link (Option) 8: RS485 link (Option) RS485 link (Option)	—	—	Y	Y	0	5-72
H42	Capacitance of DC Link Bus Capacitor	Indication for replacing DC link bus capacitor (0000 to FFFF: Hexadecimal)	1	—	Y	N	—	—
H43	Cumulative Run Time of Cooling Fan	Indication of cumulative run time of cooling fan for replacement	—	—	Y	N	—	—
H47	Initial Capacitance of DC Link Bus Capacitor	Indication for replacing DC link bus capacitor (0000 to FFFF: Hexadecimal)	—	—	Y	N	Set at factory shipping	—
H48	Cumulative Run Time of Capacitors on the Printed Circuit Board	Indication for replacing capacitors on printed circuit board (0000 to FFFF: Hexadecimal). Resettable.	—	—	Y	N	—	—
H49	Select Starting Characteristics (Auto search time for idling motor speed)	0.0 to 10.0	0.1	s	Y	Y	0.0	—
H50	Non-linear V/f Pattern (Frequency)	0.0: Cancel 0.1 to 120.0	0.1	Hz	N	Y	0.0 (22 kW or below) 5.0 (30 kW or above)*1	5-24
H51	(Voltage)	0 to 240: Output a voltage AVR-controlled (for 200 V series) 0 to 500: Output a voltage AVR-controlled (for 400 V series)	1	V	N	Y2	Refer to table below.	—
H56	Deceleration Time for Forced Stop	0.00 to 3600	0.01	s	Y	Y	20.0	—
H63	Low Limiter (Mode selection)	0: Limit by F16 (Frequency Limiter: Low) and continue to run 1: If the output frequency lowers less than the one limited by F16 (Frequency Limiter: Low), decelerates to stop the motor.	—	—	Y	Y	0	—
H64	(Lower limiting frequency)	0.0 (Depends on F16 (Frequency Limiter: Low)) 0.1 to 60.0	0.1	Hz	Y	Y	2.0	—
H69	Automatic Deceleration	0: Disable 3: Enable (Control DC link bus voltage at a constant.)	—	—	Y	Y	0	5-74
H70	Overload Prevention Control	0.00: Follow deceleration time specified by F08 0.01 to 100.00 999: Disable	0.01	Hz/s	Y	Y	999	—
H71	Deceleration Characteristics	0: Disable 1: Enable	—	—	Y	Y	0	—

*1 The factory default of H50 is "5.0 Hz." If initialized by H03, the data reverts to "6.0 Hz."

■ Factory defaults (H51)

Inverter rated capacity (kW)	Factory defaults				
	Asia (A)		Taiwan and Korea (K)		EU (E)
	200 V series	400 V series	200 V series	400 V series	400 V series
22 kW or below	0.0	0.0	0.0	0.0	0.0
30 kW or above	20 V	42 V *2	20 V	40 V	10 V

*2 The factory default of H51 is "42 V." If initialized by H03, the data reverts to "38 V."

(H code continued)

Code	Name	Data setting range	Increment	Unit	Change when running	Data copying	Default setting	Refer to page:		
H80	Gain for Suppression of Output Current Fluctuation for Motor	0.00 to 0.40	0.01	—	Y	Y	—	*3 Depend- ing on the inverter capacity		
H86	Reserved. *2	0 to 2	1	—	Y	Y1 Y2	—	*4 Depend- ing on the inverter capacity		
H87	Reserved. *2	25.0 to 120.0	0.1	Hz	Y	Y	25.0			
H88	Reserved. *2	0 to 3,999	1	—	Y	N	0			
H89	Reserved. *2	0, 1	—	—	Y	Y	0			
H90	Reserved. *2	0, 1	—	—	Y	Y	0			
H91	PID Feedback Wire Break Detection *5	0: Disable 0.1 to 60.0: Detection time	0.1	s	Y	Y	0.0	5-74		
H92	Continue to Run (P-component: gain)	0.000 to 10,000.999 *1	0.001	Times	Y	Y1 Y2	999	—		
H93	(I-component: time)	0.010 to 10,000.999 *1	0.001	s	Y	Y1 Y2	999			
H94	Cumulative Run Time of Motor	Change or reset the cumulative data	—	—	N	N	—	5-75		
H95	DC Braking (Braking response mode)	0: Slow 1: Quick	—	—	Y	Y	1	5-40		
H96	STOP Key Priority/ Start Check Function	Data	STOP key priority	Start check function	—	—	Y	Y	0	—
		0:	Disable	Disable						
		1:	Enable	Disable						
		2:	Disable	Enable						
		3:	Enable	Enable						
H97	Clear Alarm Data	Setting H97 data to "1" clears alarm data and the n returns to zero.	—	—	Y	N	0	5-75		
H98	Protection/ Maintenance Function	0 to 63: Display data on the keypad's LED monitor in decimal format (In each bit, "0" for disabled, "1" for enabled.) Bit 0: Lower the carrier frequency automatically Bit 1: Detect input phase loss Bit 2: Detect output phase loss Bit 3: Select life judgment criteria of DC link bus capacitor Bit 4: Judge the life of DC link bus capacitor Bit 5: Detect DC fan lock	—	—	Y	Y	19 (Bits 4, 1, 0 = 1 Bits 5, 3, 2 = 0)			

*1 When you make settings from the keypad, the incremental unit is restricted by the number of digits that the LED monitor can display.

(Example) If the setting range is from -200.00 to 200.00, the incremental unit is:

"1" for -200 to -100, "0.1" for -99.9 to -10.0 and for 100.0 to 200.0, and "0.01" for -9.99 to -0.01 and for 0.00 to 99.99.

*2 The H86 through H91 are displayed, but they are reserved for particular manufacturers. Unless otherwise specified, do not access these function codes.

*3 Select 0.10 for models of 45 kW or above (200 V series) and 55 kW or above (400 V series), 0.20 for models of 37 kW or below (200 V series) and 45 kW or below (400 V series).

*4 Select 2 for models of 45 kW or above (200 V series) and 55 kW or above (400 V series), 0 for models of 37 kW or below (200 V series) and 45 kW or below (400 V series).

*5 Available for inverters having a ROM version 1400 or later.

J codes: Application Functions

Code	Name	Data setting range	Increment	Unit	Change when running	Data copying	Default setting	Refer to page:
J01	PID Control (Mode selection)	0: Disable 1: Enable (normal operation) 2: Enable (inverse operation)	—	—	N	Y	0	—
J02	(Remote process command)	0: Enable (⊙/⊙) keys on keypad 1: PID process command 1 3: Enable terminal command (UP) / (DOWN) control 4: Command via communications link	—	—	N	Y	0	
J03	P (Gain)	0.000 to 30.000 *1	0.001	Times	Y	Y	0.100	
J04	I (Integral time)	0.0 to 3600.0 *1	0.1	s	Y	Y	0.0	
J05	D (Differential time)	0.00 to 600.00 *1	0.01	s	Y	Y	0.00	
J06	(Feedback filter)	0.0 to 900.0	0.1	s	Y	Y	0.5	
J10	(Anti reset windup)	0 to 200	1	%	Y	Y	200	
J11	(Select alarm output)	0: Absolute-value alarm 1: Absolute-value alarm (with Hold) 2: Absolute-value alarm (with Latch) 3: Absolute-value alarm (with Hold and Latch) 4: Deviation alarm 5: Deviation alarm (with Hold) 6: Deviation alarm (with Latch) 7: Deviation alarm (with Hold and Latch)	—	—	Y	Y	0	
J12	(Upper limit alarm (AH))	0 to 100	1	%	Y	Y	100	
J13	(Lower limit alarm (AL))	0 to 100	1	%	Y	Y	0	
J15	(Stop frequency for slow flowrate)	0: Disable 1 to 120	1	Hz	Y	Y	0	
J16	(Slow flowrate level stop latency)	1 to 60	1	s	Y	Y	30	
J17	(Starting frequency)	0: Disable 1 to 120	1	Hz	Y	Y	0	
J18	(Upper limit of PID process output)	1 to 120 999: Depends on setting of F15	1	Hz	Y	Y	999	
J19	(Lower limit of PID process output)	1 to 120 999: Depends on setting of F16	1	Hz	Y	Y	999	
J21	Dew Condensation Prevention (Duty)	1 to 50	1	%	Y	Y	1	5-79
J22	Commercial Power Switching Sequence	0: Keep inverter operation (Stop due to alarm) 1: Automatically switch to commercial-power operation	—	—	N	Y	0	—

*1 When you make settings from the keypad, the incremental unit is restricted by the number of digits that the LED monitor can display.

(Example) If the setting range is from -200.00 to 200.00, the incremental unit is:

"1" for -200 to -100, "0.1" for -99.9 to -10.0 and for 100.0 to 200.0, and "0.01" for -9.99 to -0.01 and for 0.00 to 99.99.

(J code continued)

Code	Name	Data setting range	Increment	Unit	Change when running	Data copying	Default setting	Refer to page:
J25	Pump Control (Mode selection)	0: Disable 1: Enable (Fixed, inverter-driven) 2: Enable (Floating, inverter-driven)	—	—	N	Y	0	—
J26	Motor 1 Mode	0: Disable (Always OFF) 1: Enable 2: Force to run by commercial power	—	—	Y	Y	0	
J27	Motor 2 Mode		—	—	Y	Y	0	
J28	Motor 3 Mode		—	—	Y	Y	0	
J29	Motor 4 Mode		—	—	Y	Y	0	
J30	Motor Switching Order	0: Fixed 1: Automatically (Constant run time)	—	—	N	Y	0	
J31	Motor Stop Mode	0: Stop all motors (inverter- and commercial power-driven) 1: Stop inverter-driven motor only (excl. alarm state) 2: Stop inverter-driven motor only (incl. alarm state)	—	—	N	Y	0	
J32	Periodic Switching Time for Motor Drive	0.0: Disable switching 0.1 to 720.0: Switching time range 999: Fix to 3 minutes	0.1	h	N	Y	0.0	
J33	Periodic Switching Signaling Period	0.00 to 600.00	0.01	s	Y	Y	0.1	
J34	Mount of Commercial Power-driven Motor (Frequency)	0 to 120 999: Depends on setting of J18 (This code is used to judge whether or not to mount a commercial power-driven motor by checking the output frequency of the inverter-driven motor.)	1	Hz	Y	Y	999	
J35	(Duration)	0.00 to 3600	Variable	s	Y	Y	0	
J36	Unmount of Commercial Power-driven Motor (Frequency)	0 to 120 999: Depends on setting of J19 (This code is used to judge whether or not to unmount a commercial power-driven motor by checking the output frequency of the inverter-driven motor.)	1	Hz	Y	Y	999	
J37	(Duration)	0.00 to 3600	Variable	s	Y	Y	0	
J38	Contacting Delay Time	0.01 to 2.00	0.01	s	Y	Y	0.01	
J39	Switching Time for Motor Mount (Decl. time)	0.00: Depends on the setting of F08, 0.01 to 3600	Variable	s	Y	Y	0.00	
J40	Switching Time for Motor Unmount (Accel. time)	0.00: Depends on the setting of F07, 0.01 to 3600	Variable	s	Y	Y	0.00	
J41	Motor Mount/Unmount Switching Level	0 to 100	1	%	Y	Y	0	
J42	Switching Motor Mount/ Unmount (Dead band)	0.0: Disable 0.1 to 50.0	0.1	%	Y	Y	0.0	

(J code continued)

Code	Name	Data setting range	Increment	Unit	Change when running	Data copying	Default setting	Refer to page:
J43	PID Control Startup Frequency	0: Disable 1 to 120 999: Depends on the setting of J36	1	Hz	Y	Y	999	—
J45	Signal Assignment to: (For relay output card)	Selecting function code data assigns the corresponding function to terminals [Y1A/B/C], [Y2A/B/C], and [Y3A/B/C].	—	—	N	Y	100	
J46	[Y1A/B/C]	100: Depends on the setting of E20 to E22	—	—	N	Y	100	
J47	[Y2A/B/C]	60 (1060): Mount motor 1, inverter-driven (M1_I)	—	—	N	Y	100	
	[Y3A/B/C]	61 (1061): Mount motor 1, commercial-power-driven (M1_L)						
		62 (1062): Mount motor 2, inverter-driven (M2_I)						
		63 (1063): Mount motor 2, commercial-power-driven (M2_L)						
		64 (1064): Mount motor 3, inverter-driven (M3_I)						
		65 (1065): Mount motor 3, commercial-power-driven (M3_L)						
		67 (1067): Mount motor 4, commercial-power-driven (M4_L)						
		68 (1068): Periodic switching early warning (MCHG)						
		69 (1069): Pump control limit signal (MLIM)						
J48	Cumulative Run Time of Motor	Indication of cumulative run time of motor for replacement	1	h	Y	Y	—	
J49	(Motor 1)		1	h	Y	Y	—	
J50	(Motor 2)		1	h	Y	Y	—	
J51	(Motor 3)		1	h	Y	Y	—	
J52	(Motor 4)		1	h	Y	Y	—	
J53	Maximum Cumulative Number of Relay ON Times [Y1A/B/C] to [Y3A/B/C]	Indication of the maximum number of ON times of relay contacts on the relay output card or those built in inverter Display of 1.000 means 1000 times.	1	Times	Y	Y	—	
J54	[Y1], [Y2], [Y3]	For relay output card	1	Times	Y	Y	—	
J55	[Y5A], [30A/B/C]	For built-in mechanical contacts	1	Times	Y	Y	—	

y codes: Link Functions

Code	Name	Data setting range	Increment	Unit	Change when running	Data copying	Default setting	Refer to page:
y01	RS485 Communication (Standard) (Station address)	1 to 255	1	—	N	Y	1	—
y02	(Communications error processing)	0: Immediately trip and alarm $\mathcal{E}\text{-}\mathcal{B}$ 1: Trip and alarm $\mathcal{E}\text{-}\mathcal{B}$ after running for the period specified by timer y03 2: Retry during the period specified by timer y03. If retry fails, trip and alarm $\mathcal{E}\text{-}\mathcal{B}$. If it succeeds, continue to run. 3: Continue to run	—	—	Y	Y	0	
y03	(Error processing timer)	0.0 to 60.0	0.1	s	Y	Y	2.0	
y04	(Transmission speed)	0: 2400 bps 1: 4800 bps 2: 9600 bps 3: 19200 bps 4: 38400 bps	—	—	Y	Y	3	
y05	(Data length)	0: 8 bits 1: 7 bits	—	—	Y	Y	0	
y06	(Parity check)	0: None 1: Even parity 2: Odd parity	—	—	Y	Y	0	
y07	(Stop bits)	0: 2 bits 1: 1 bit	—	—	Y	Y	0	
y08	(No-response error detection time)	0 (No detection), 1 to 60	1	s	Y	Y	0	
y09	(Response latency time)	0.00 to 1.00	0.01	s	Y	Y	0.01	
y10	(Protocol selection)	0: Modbus RTU protocol 1: FRENIC Loader protocol (SX protocol) 2: Fuji general-purpose inverter protocol 3: Metasys-N2 (Available only for products shipped for Asia (A) and EU (E))	—	—	Y	Y	1	

(y code continued)







Code	Name	Data setting range	Increment	Unit	Change when running	Data copying	Default setting	Refer to page:	
y11	RS485 Communication (Option) (Station address)	1 to 255	1	—	N	Y	1	—	
y12	(Communications error processing)	0: Immediately trip and alarm $E_{rr}P$ 1: Trip and alarm $E_{rr}P$ after running for the period specified by timer y13. 2: Retry during the period specified by timer y13. If retry fails, trip and alarm $E_{rr}P$. If it succeeds, continue to run. 3: Continue to run.	—	—	Y	Y	0		
y13	(Error processing timer)	0.0 to 60.0	0.1	s	Y	Y	2.0		
y14	(Transmission speed)	0: 2400 bps 1: 4800 bps 2: 9600 bps 3: 19200 bps 4: 38400 bps	—	—	Y	Y	3		
y15	(Data length)	0: 8 bits 1: 7 bits	—	—	Y	Y	0		
y16	(Parity check)	0: None 1: Even parity 2: Odd parity	—	—	Y	Y	0		
y17	(Stop bits)	0: 2 bits 1: 1 bit	—	—	Y	Y	0		
y18	(No-response error detection time)	0: (No detection), 1 to 60	1	s	Y	Y	0		
y19	(Response latency time)	0.00 to 1.00	0.01	s	Y	Y	0.01		
y20	(Protocol selection)	0: Modbus RTU protocol 2: Fujii general-purpose inverter protocol 3: Metasys-N2 (Available only for products shipped for Asia (A) and EU (E))	—	—	Y	Y	0		
y98	Bus Link Function (Mode selection)	Frequency command	Run command	—	—	Y	Y	0	5-72
		0: Follow H30 data	Follow H30 data						
		1: Via field bus option	Follow H30 data						
		2: Follow H30 data	Via field bus option						
		3: Via field bus option	Via field bus option						
y99	Loader Link Function (Mode selection)	Frequency command	Run command	—	—	Y	N	0	—
		0: Follow H30 and y98 data	Follow H30 and y98 data						
		1: Via RS485 link (Loader)	Follow H30 and y98 data						
		2: Follow H30 and y98 data	Via RS485 link (Loader)						
		3: Via RS485 link (Loader)	Via RS485 link (Loader)						

5.2 Overview of Function Codes

This section provides an overview of the function codes frequently used for the FRENIC-Eco series of inverter.

 For details of the function codes given below and other function codes not given below, refer to the FRENIC-Eco User's Manual (MEH456), Chapter 9 "FUNCTION CODES."



F00 Data Protection

F00 specifies whether function code data is to be protected from being accidentally changed by keypad operation. If data protection is enabled (F00 = 1), the  /  key operation to change data is disabled so that no function code data except F00 data can be changed from the keypad. To change F00 data, simultaneous keying of  +  (from 0 to 1) or  +  (from 1 to 0) keys is required.

 **Tip** Even when F00 = 1, function code data can be changed via the communications link. For similar purposes, (WE-KP), a signal enabling editing of function code data from the keypad is provided as a terminal command for digital input terminals. For details, refer to function codes E01 to E05, E98 and E99.

F01 Frequency Command 1 C30 Frequency Command 2

F01 selects the source of reference frequency 1 (F01) or reference frequency 2 (C30) for specifying the output frequency of the inverter (motor speed).

Data for F01, C30	Function
0	Enable  /  keys on the keypad. (Refer to Chapter 3 "OPERATION USING THE KEYPAD.")
1	Enable the voltage input to terminal [12] (0 to 10 VDC, maximum frequency obtained at 10 VDC).
2	Enable the current input to terminal [C1] (4 to 20 mA DC, maximum frequency obtained at 20 mA DC).
3	Enable the sum of voltage and current inputs to terminals [12] and [C1]. See the two items listed above for the setting range and the value required for maximum frequencies. Note: If the sum exceeds the maximum frequency (F03), the maximum frequency will apply.
5	Enable the voltage input to terminal [V2] (0 to 10 VDC, maximum frequency obtained at 10 VDC).
7	Enable (UP) and (DOWN) commands assigned to the digital input terminals. Assign (UP) command (data = 17) and (DOWN) command (data = 18) to the digital input terminals [X1] to [X5].

 **Note** Certain source settings (e.g., communications link and multistep frequency) have priority over the one specified by F01. For details, refer to the block diagram in the FRENIC-Eco User's Manual (MEH456), Chapter 4, Section 4.2 "Drive Frequency Command Generator."



- You can modify the reference frequency anywhere you choose using the gain and bias settings, to these analog inputs (voltages entered via terminals [12] and [V2]; the current entered via terminal [C1]). For details, refer to function code F18.
- You can enable the noise reduction filter that applies to the analog input (voltages entered via terminals [12] and [V2]; the current entered via terminal [C1]). For details, refer to function codes C33, C38 and C43 (Terminal [12], [C1] and [V2] (Analog input) (Filter time constant)).
- Using the terminal command (Hz2/Hz1) assigned to one of the digital input terminals switches between frequency commands 1 and 2. For details, refer to function codes E01 to E05, E98 and E99.
- You can modify the reference frequency specified by frequency command 1 (F01) by using the selection (C53) and switching (IVS) of normal/inverse operation. For details, refer to the description of "Switch Normal/Inverse Operation (IVS)" in function codes E01 to E05.

F02

Run Command

F02 selects the source issuing a run command for running the motor.

Data for F02	Run Command	Description
0	Keypad	Enables the / keys to start and stop the motor. The direction of rotation is determined by the commands given at terminals [FWD] and [REV].
1	External signal	Enables the external signals given at terminals [FWD] and [REV] to run the motor.
2	Keypad (Forward rotation)	Enables / keys to run and stop the motor. Enables only forward rotation. You cannot run the motor in the reverse direction. There is no need to specify the direction of rotation.
3	Keypad (Reverse rotation)	Enables / keys to run and stop the motor. Enables only reverse rotation. You cannot run the motor in the forward direction. There is no need to specify the direction of rotation.



Note When function code F02 = 0 or 1, the run forward (FWD) and run reverse (REV) commands must be assigned to terminals [FWD] and [REV], respectively.

In addition to the run command (F02) described, there are several other sources available with priority over F02: Remote/Local switching, Communications link, Run forward command 2 (FWD2), and Run reverse command 2 (REV2). For details, refer to the block diagram in the FRENIC-Eco User's Manual (MEH456), Chapter 4, Section 4.3 "Drive Command Generator."

The table below shows relationship between keying and run commands in running per a keypad (F02 = 0, rotation direction is defined by the digital inputs).

Keying on the keypad		Digital inputs		Results (Final command)
(RUN) key	(STOP) key	(FWD)	(REV)	
—	ON	—	—	Stop
ON	OFF	OFF	OFF	Stop
ON	OFF	ON	OFF	Run forward
ON	OFF	OFF	ON	Run reverse
ON	OFF	ON	ON	Stop

- Note**
- Digital input commands (FWD) and (REV) are valid for specifying the motor rotation direction, and the commands (FWD2) and (REV2) are invalid.
 - If you have assigned the (FWD) or (REV) function to the [FWD] or [REV] terminal, you cannot change the setting of function code F02 while the terminals [FWD] and/or [REV] are on.
 - Make sure that terminals [FWD] and [REV] are off before changing the (FWD) or (REV) function from the function other than the (FWD) and (REV) functions to (FWD) or (REV) function. Because, if under this condition you assign the (FWD) or (REV) function to the [FWD] or [REV] terminal while the terminals [FWD] and/or [REV] are on, the motor would start running.

When "Local" is selected in Remote/Local switching, the operation of the keypad concerning run commands varies with the setting of F02. For details, refer to "Remote and local modes" in Chapter 3, Section 3.3.3.

F03 Maximum Frequency

F03 specifies the maximum frequency at which the motor can run. Specifying the frequency out of the range rated for the equipment driven by the inverter may cause damage or a dangerous situation. Set a maximum frequency appropriate for the equipment.

⚠ CAUTION

The inverter can easily accept high-speed operation. When changing the speed setting, carefully check the specifications of motors or equipment beforehand.

Otherwise injuries could occur.

- Note** Modifying F03 data to apply a higher output frequency requires also changing F15 data specifying a frequency limiter (high).

F04	Base Frequency
F05	Rated Voltage at Base Frequency
H50	Non-linear V/f Pattern (Frequency)
H51	Non-linear V/f Pattern (Voltage)

These function codes specify the base frequency and the voltage at the base frequency essentially required for running the motor properly. If combined with the related function codes H50 and H51, these function codes may profile the non-linear V/f pattern by specifying increase or decrease in voltage at any point on the V/f pattern.

The following description includes setups required for the non-linear V/f pattern.

At high frequencies, the motor impedance may increase, resulting in an insufficient output voltage and a decrease in output torque. This feature is used to increase the voltage at high frequencies to prevent this problem from happening. Note, however, that you cannot increase the output voltage beyond the voltage of the inverter's input power.

■ Base Frequency (F04)

Set the rated frequency printed on the nameplate labeled on the motor.

■ Rated Voltage at Base Frequency (F05)

Set 0 or the rated voltage printed on the nameplate labeled on the motor.

- If 0 is set, the rated voltage at base frequency is determined by the power source of the inverter. The output voltage will vary in line with any variance in input voltage.
- If the data is set to anything other than 0, the inverter automatically keeps the output voltage constant in line with the setting. When any of the automatic torque boost settings, automatic energy saving or slip compensation is active, the voltage settings should be equal to the rated voltage of the motor.

■ Non-linear V/f Pattern for Frequency (H50)

Set the frequency component at an arbitrary point of the non-linear V/f pattern.

(Setting 0.0 to H50 disables the non-linear V/f pattern operation.)

■ Non-linear V/f Pattern for Voltage (H51)

Sets the voltage component at an arbitrary point of the non-linear V/f pattern.

Note If the rated voltage at base frequency (F05) is set to 0, settings of function codes H50 and H51 will be ignored.

If the auto torque boost (F37) is enabled, H50 and H51 will be ignored.

Factory settings:

For models of 22 kW or below the non-linear V/f is disabled (H50 = 0, H51 = 0.)

For models of 30 kW or above it is enabled, that is, (H50 = 5 Hz, H51 = 20 V), for the 200 V series, (H50 = 5 Hz, H51 = 40 V) for 400 V series.

Function code	Name	Rated capacity (kW)	Rated input voltage*	
			200 V series	400 V series
F04	Base Frequency	5.5 to 75	50.0 Hz	50.0 Hz
F05	Rated Voltage at Base Frequency	5.5 to 75	200 V	400 V
H50	Non-linear V/f Pattern (Frequency)	30 or below	0 Hz	0 Hz
		37 or above	5.0 Hz	5.0 Hz
H51	Non-linear V/f Pattern (Voltage)	30 or below	0 Hz	0 Hz
		37 or above	20 V	40 V

*For Japanese models

Example:

- Normal (linear) V/f pattern

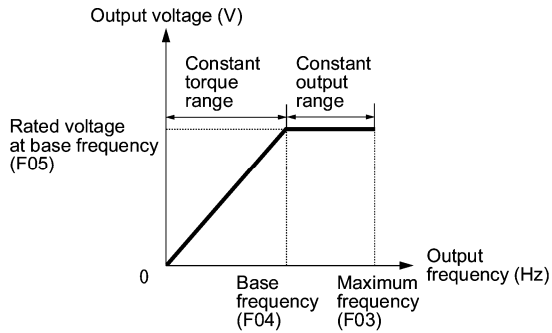

- V/f Pattern with Non-linear Point below the Base Frequency

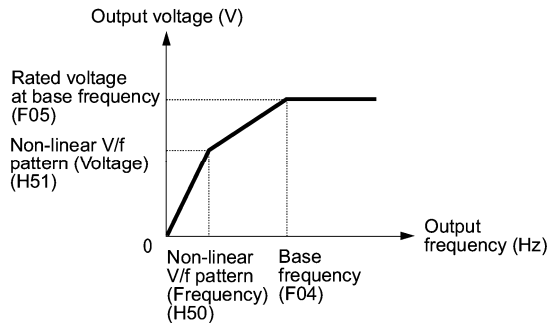

- V/f Pattern with Non-linear Point above the Base Frequency

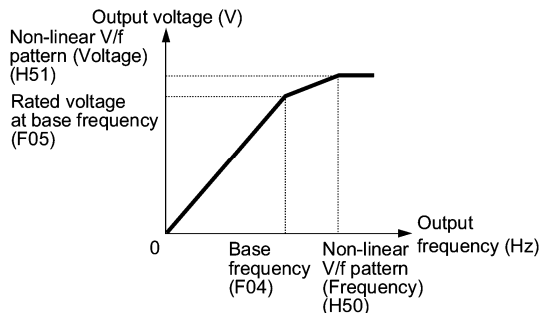

F07
F08

Acceleration Time 1
Deceleration Time 1

F07 specifies the acceleration time, the length of time the frequency increases from 0 Hz to the maximum frequency. F08 specifies the deceleration time, the length of time the frequency decreases from the maximum frequency down to 0 Hz.

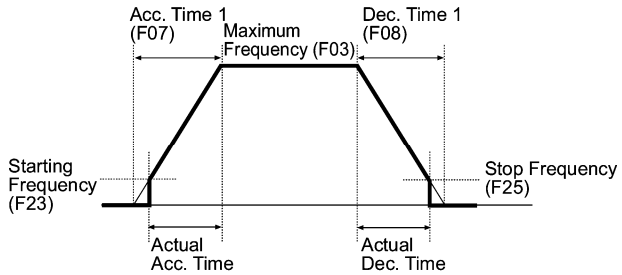

- Note**
- If you choose S-curve acceleration/deceleration or curvilinear acceleration/deceleration in Acceleration/Deceleration Pattern (H07), the actual acceleration/deceleration times are longer than the specified times. Refer to the descriptions of H07 for details.
 - If you specify an improperly long acceleration/deceleration time, the current limiting function or the automatic deceleration function (regenerative bypass function) may be activated, resulting in an actual acceleration/deceleration time longer than the specified one.

F09
F37

Torque Boost
Load Selection/Auto Torque Boost/Auto Energy Saving Operation

F37 specifies V/f pattern, torque boost type, and auto energy saving operation for optimizing the operation in accordance with the characteristics of the load. F09 specifies the type of torque boost in order to provide sufficient starting torque.

Data for F37	V/f pattern	Torque boost	Auto-energy saving	Applicable load
0	Variable torque load	Torque boost specified by F09	Disabled	General purpose fans and pumps
1	Constant torque load			Pumps require high starting torque*
2		Auto-torque boost	Pumps require high start torque (A motor may be over-excited at no load.)	
3	Variable torque load	Torque boost specified by F09	Enabled	General-purpose fans and pumps
4	Constant torque load			Pumps require high start torque*
5		Auto torque boost		Pumps require high start torque (A motor may be over-excited at no load.)

* If a required (load torque + acceleration torque) is more than 50% of the linear torque, it is recommended to apply the linear V/f pattern (factory default).

Note FRENIC-Eco is a series of inverters exclusively designed for fans and pumps whose torque loads are characterized by a term of variable torque load that is a torque load increasing proportional to square of the load speed. FRENIC-Eco cannot drive any linear torque load even if you select a linear V/f pattern. If you attempt to drive a linear torque load with a FRENIC-Eco inverter, the inverter's current limit function may be activated or an insufficient torque situation may result, and you would need to reduce the inverter output. For details, contact your Fuji Electric representative.

■ V/f characteristics

The FRENIC-Eco series of inverters offers a variety of V/f patterns and torque boosts, which include V/f patterns suitable for variable torque load such as general fans and pumps or for special pump load requiring high start torque. Two types of torque boost are available: manual and automatic.

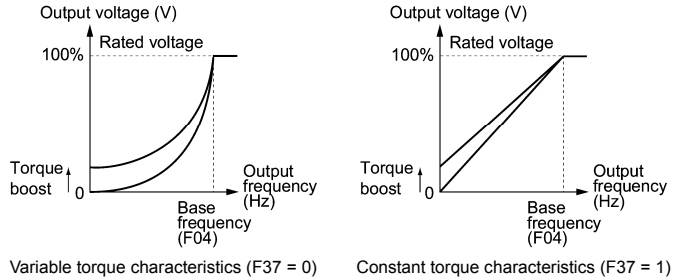

Tip When the variable torque load characteristics is selected in function code F37 (= 0 or 3), the output voltage may be low and insufficient voltage output may result in less output torque of the motor at a low frequency zone, depending on some motor itself and load characteristics. In such a case, it is recommended to increase the output voltage at the low frequency zone using the non-linear V/f pattern.

Recommended value: H50 = 1/10 of the base frequency
 H51 = 1/10 of the voltage at base frequency

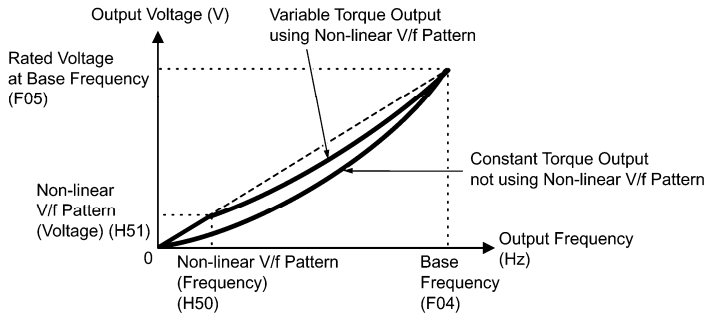

■ Torque boost

- Manual torque boost (F09)

In torque boost using F09, constant voltage is added to the basic V/f pattern, regardless of the load, to give the output voltage. To secure a sufficient start torque, manually adjust the output voltage to optimally match the motor and its load by using F09. Select an appropriate level that guarantees smooth start-up and yet does not cause over-excitation with no or light load.

Torque boost per F09 ensures high driving stability since the output voltage remains constant regardless of the load fluctuation.

Specify the data for F09 in percentage to the rated voltage at base frequency (F05). At factory shipment, F09 is preset to a level that provides approx. 50% of starting torque.

Note Specifying a high torque boost level will generate a high torque, but may cause over-current due to over-excitation at no load. If you continue to drive the motor, it may overheat. To avoid such a situation, adjust torque boost to an appropriate level.

When the non-linear V/f pattern and the torque boost are used together, the torque boost takes effect below the frequency on the non-linear V/f pattern's point.

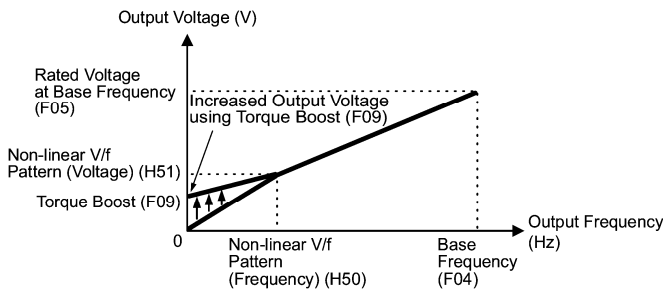

■ Automatic torque boost

This function automatically optimizes the output voltage to fit the motor with its load. Under light load, automatic torque boost decreases the output voltage to prevent the motor from over-excitation. Under heavy load, it increases the output voltage to increase output torque of the motor.

- Note**
- Since this function relies also on the characteristics of the motor, set the base frequency (F04), the rated voltage at base frequency (F05), and other pertinent motor parameters (P01 through P03 and P06 through P99) in line with the motor capacity and characteristics, or else perform auto tuning per P04.
 - When a special motor is driven or the load does not have sufficient rigidity, the maximum torque might decrease or the motor operation might become unstable. In such cases, do not use automatic torque boost but choose manual torque boost per F09 (F37 = 0 or 1).

■ Auto energy saving operation

This feature automatically controls the supply voltage to the motor to minimize the total power consumption of motor and inverter. (Note that this feature may not be effective depending upon the motor or load characteristics. Check the advantage of energy saving before actually apply this feature to your power system.)

The inverter enables this feature only upon constant speed operation. During acceleration and deceleration, the inverter will run with manual torque boost (F09) or automatic torque boost, depending on data of the function code F37. If auto energy saving operation is enabled, the response to a change in motor speed may be slow. Do not use this feature for a system that requires quick acceleration and deceleration.

- Note**
- Use auto energy saving only where the base frequency is 60 Hz or lower. If the base frequency is set at 60 Hz or higher, you may get little or no energy saving advantage. The auto energy saving operation is designed for use with the frequency lower than the base frequency. If the frequency becomes higher than the base frequency, the auto energy saving operation will be invalid.
 - Since this function relies also on the characteristics of the motor, set the base frequency (F04), the rated voltage at base frequency (F05), and other pertinent motor parameters (P01 through P03 and P06 through P99) in line with the motor capacity and characteristics, or else perform auto tuning per P04.

F10 to F12

Electronic Thermal Overload Protection for Motor
(Select motor characteristics, Overload detection level, and Thermal time constant)

F10 through F12 specify the thermal characteristics of the motor for its electronic thermal overload protection that is used to detect overload conditions of the motor inside the inverter.

F10 selects the motor cooling mechanism to specify its characteristics, F11 specifies the overload detection current, and F12 specifies the thermal time constant.

Note Thermal characteristics of the motor specified by F10 and F12 are also used for the overload early warning. Even if you need only the overload early warning, set these characteristics data to these function codes. To disable the electronic thermal motor overload protection, set function code F11 to "0.00."

■ Select motor characteristics (F10)

F10 selects the cooling mechanism of the motor--built-in cooling fan or externally powered forced-ventilation fan.

Data for F10	Function
1	For general-purpose motors with built-in self-cooling fan (The cooling effect will decrease in low frequency operation.)
2	For inverter-driven motors or high-speed motors with forced-ventilation fan (The cooling effect will be kept constant regardless of the output frequency.)

The figure below shows operating characteristics of the electronic thermal overload protection when F10 = 1. The characteristic factors $\alpha 1$ through $\alpha 3$ as well as their corresponding switching frequencies f_2 and f_3 vary with the characteristics of the motor. The tables below lists the factors of the motor selected by P99 (Motor Selection).

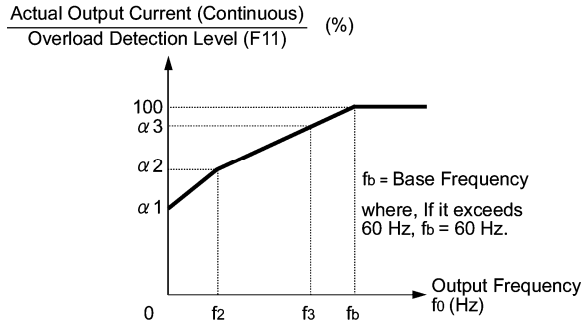

Cooling Characteristics of Motor Equipped with a Self-cooling Fan

Applicable Motor Rating and Characteristic Factors when P99 (Motor selection) = 0 or 4

Applicable motor rating (kW)	Thermal time constant τ (Factory default)	Output current for setting the thermal time constant (I _{max})	Switching frequency for motor characteristic factor		Characteristic factor (%)		
			f2	f3	α_1	α_2	α_3
0.4, 0.75	5 min	Rated current \times 150%	5 Hz	7 Hz	75	85	100
1.5 to 3.7					85	85	100
5.5 to 11					90	95	100
15					85	85	100
18.5, 22					92	100	100
30 to 45	10 min		Base frequency \times 33%	Base frequency \times 83%	54	85	95
55 to 90					51	95	95
110 or above					53	85	90

Applicable Motor Rating and Characteristic Factors when P99 (Motor selection) = 1 or 3

Applicable motor rating (kW)	Thermal time constant τ (Factory default)	Output current for setting the thermal time constant (I _{max})	Switching frequency for motor characteristic factor		Characteristic factor (%)		
			f2	f3	α_1	α_2	α_3
0.2 to 22	5 min	Rated current \times 150%	Base frequency \times 33%	Base frequency \times 83%	69	90	90
30 to 45	10 min				54	85	95
55 to 90					51	95	95
110 or above					53	85	90

■ Overload detection level (F11)

F11 specifies the level at which the electronic thermal overload protection becomes activated.

In general, set F11 to the rated current of motor when driven at the base frequency (i.e. 1.0 to 1.1 multiple of the rated current of motor (P03)). To disable the electronic thermal overload protection, set F11 to "0.00: Disable."

■ Thermal time constant (F12)

F12 specifies the thermal time constant of the motor. The time constant is the time until the electronic thermal overload protection detects the motor overload while the current of 150% of the overload detection level specified by F11 has flown. The thermal constants of most general-purpose motors including Fuji motors are set at about 5 minutes for capacities of 22 kW or below or about 10 minutes for capacities of 30 kW or above by factory default.

(Example) When function code F12 is set at "5.0" (5 minutes)

As shown below, the electronic thermal overload protection is activated to detect an alarm condition (alarm code \overline{OL} /) when the output current of 150% of the overload detection level (specified by F11) flows for 5 minutes, and 120% for approx. 12.5 minutes.

The actual driving time required for issuing a motor overload alarm tends to be shorter than the value specified as the time period from when the output current exceeds the rated current (100 %) until it reaches 150 % of the overload detection level.

Example of Operating Characteristics

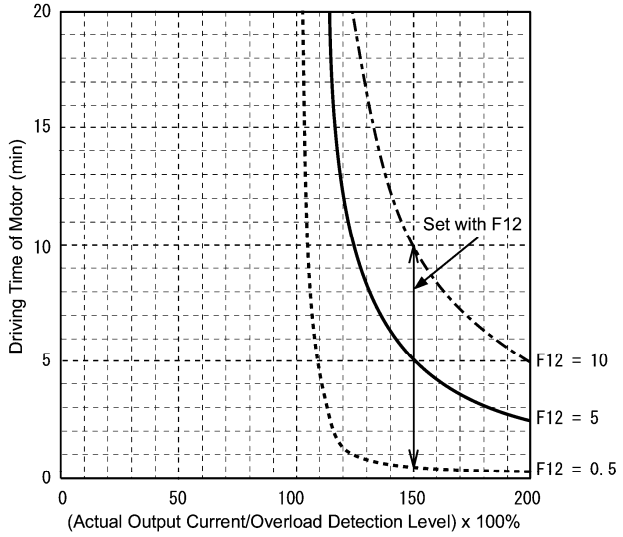

F14	Restart Mode after Momentary Power Failure	(Mode selection)
H13	Restart after Momentary Power Failure	(Restart time)
H14		(Frequency fall rate)
H16		(Allowable momentary power failure time)

F14 specifies the action to be taken by the inverter such as trip and restart in the event of a momentary power failure.

■ Restart mode after momentary power failure (Mode selection) (F14)

Data for F14	Mode	Description
0	Disable restart (Trip immediately)	As soon as the DC link bus voltage drops below the undervoltage detection level upon a momentary power failure, the output of the inverter is shut down, with undervoltage alarm $\mathcal{L}\mathcal{L}$ issued, and the motor enters a coast-to-stop state.
1	Disable restart (Trip after a recovery from power failure)	As soon as the DC link bus voltage drops below the undervoltage detection level upon a momentary power failure, the output of the inverter is shut down, the motor enters a coast-to-stop state, but no undervoltage alarm $\mathcal{L}\mathcal{L}$ issued. When power is restored, an undervoltage alarm $\mathcal{L}\mathcal{L}$ is issued, while the motor remains in a coast-to-stop state.
3	Enable restart (Continue to run, for heavy inertia or general loads)	When the DC link bus voltage drops below the continuous running level upon a momentary power failure, continuous running control is invoked. Continuous running control regenerates kinetic energy from the load's moment of inertia, slowing down the motor and prolongs the running time. When an undervoltage condition is detected due to a lack of energy to be regenerated, the output frequency at that time is saved, the output of the inverter is shut down, and the motor enters a coast-to-stop state. When power is restored, if a run command has been input, restart begins at the reference frequency saved during the power failure processing. This setting is ideal for fan applications with a large moment of inertia.
4	Enable restart (Restart at the frequency at which the power failure occurred, for general loads)	As soon as the voltage of the DC link bus drops below the undervoltage detection level upon a momentary power failure, the output frequency at the time is saved, the output of the inverter is shut down, and the motor enters a coast-to-stop state. When power is restored, if a run command has been input restart begins at the reference frequency saved during the power failure processing. This setting is ideal for applications with a moment of inertia large enough not to slow down the motor quickly, such as fans, even after the motor enters a coast-to-stop state upon occurrence of a momentary power failure.
5	Enable: Restart at the starting frequency, for low-inertia load	After a momentary power failure, when power is restored and then a run command is input, restart will begin at the starting frequency commanded by function code F23. This setting is ideal for heavy load applications such as pumps, having a small moment of inertia, in which the motor speed quickly goes down to zero as soon as it enters a coast-to-stop state upon occurrence of a momentary power failure.

WARNING

If you enable the "Restart mode after momentary power failure" (Function code F14 = 3, 4, or 5), the inverter automatically restarts the motor running when the power is recovered. Design the machinery or equipment so that human safety is ensured after restarting.

Otherwise an accident could occur.

■ Restart mode after momentary power failure (Basic operation)

The inverter recognizes a momentary power failure upon detecting the condition that DC link bus voltage goes below the undervoltage level, while the inverter is running. If the load of the motor is light and the duration of the momentary power failure is extremely short, the voltage drop may not be great enough for a momentary power failure to be recognized, and the motor may continue to run uninterrupted.

Upon recognizing a momentary power failure, the inverter enters the restart mode (after a recovery from momentary power failure) and prepares for restart. When power is recovered, the inverter goes through an initial charging stage and enters the ready-to-run state. When a momentary power failure occurs, the power supply voltage for external circuits such as relay sequence circuits may also drop, the run command may be turned off. In consideration of such a situation, the inverter waits 2 seconds for input of a run command after the inverter enters ready-to-run state. If a run command is received within 2 seconds, the inverter begins the restart processing in accordance with the data of F14 (Mode selection). If no run command has been received within 2-second wait period, the restart mode (after a recovery from momentary power failure) will be canceled, and the inverter needs to be started again from the ordinary starting frequency. Therefore, ensure that a run command is entered within 2 seconds after a recovery of power, or install a mechanical latch relay.

In case the run commands are entered via the keypad, the above operation is also necessary for the mode (F02 = 0) in which the direction of rotation is determined by the terminal command, (FWD) or (REV). In the modes where the direction of rotation is fixed (F02 = 2 or 3), the direction of rotation is retained inside the inverter, and the restart will begin as soon as the inverter enters the ready-to-run state.

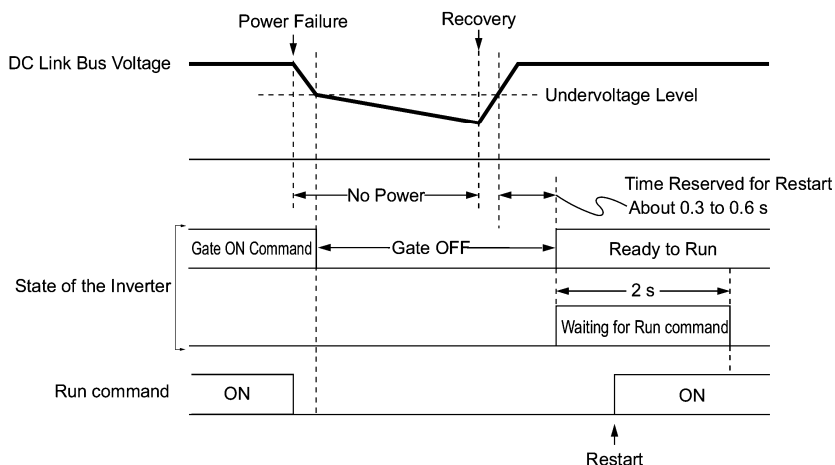



When the power is recovered, the inverter will wait 2 seconds for input of a run command. However, if the allowable momentary power failure time (H16) elapses after the power failure was recognized, even within the 2 seconds, the waiting time for a run command is canceled. The inverter will start operation in the normal starting sequence.

If a coast-to-stop command (BX) is entered during the power failure, the inverter gets out of the restart mode and enters the normal running mode. If a run command is entered with power supply applied, the inverter will start from the normal starting frequency.

The inverter recognizes a momentary power failure by detecting an undervoltage condition whereby the voltage of the DC link bus goes below the lower limit. In a configuration where a magnetic contactor is installed on the output side of the inverter, the inverter may fail to recognize a momentary power failure because the momentary power failure shuts down the operating power of the magnetic contactor, causing the contactor circuit to open. When the contactor circuit is open, the inverter is cut off from the motor and load, and the voltage drop in the DC link bus is not great enough to be recognized as a power failure. In such an event, restart after a recovery from momentary power failure does not work properly as designed. To solve this, connect the interlock command (IL) line to the auxiliary contact of the magnetic contactor, so that a momentary power failure can sure be detected.

During a momentary power failure the motor slows down. After power has been recovered, the inverter is restarted at the frequency just before the momentary power failure. Then, the current limiting function works and the output frequency of the inverter automatically decreases. When the output frequency matches the motor speed, the motor accelerates up to the original frequency. See the figure below. In this case, the instantaneous overcurrent limiting must be enabled (H12 = 1).

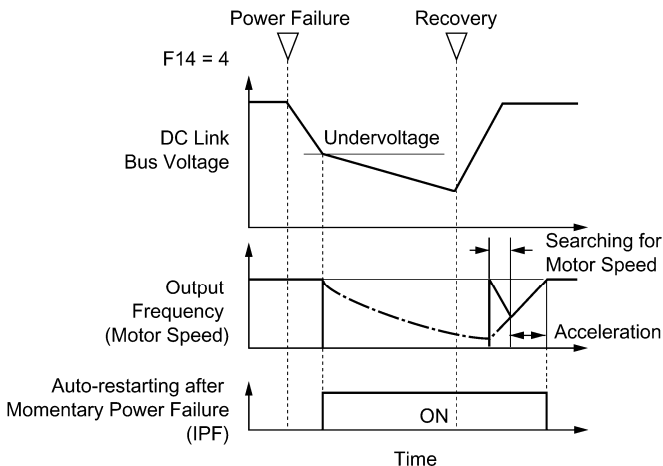

■ Restart mode after momentary power failure
(Allowable momentary power failure time) (H16)

H16 specifies the maximum allowable duration (0.0 to 30.0 seconds) from an occurrence of a momentary power failure (undervoltage) until the inverter is to be restarted. Specify the coast-to-stop time during which the machine system and facility can be tolerated.

If the power is recovered within the specified duration, the inverter restarts in the restart mode specified by F14. If the power is recovered after the specified duration, the inverter recognizes that the power has been shut down so that it does not restart but starts (normal starting).

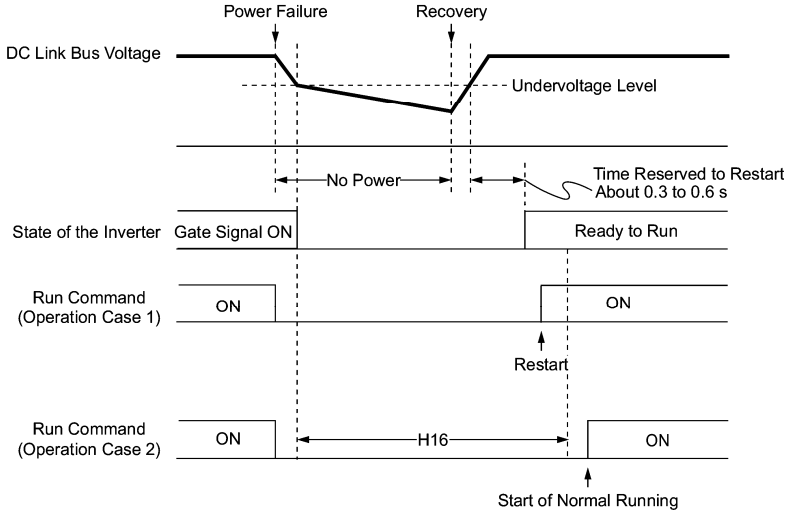

If you set the allowable momentary power failure time (H16) to "999," restart will take place until the DC link bus voltage drops down to the allowable voltage for restart after a momentary power failure as shown below. If the DC link bus voltage drops below the allowable voltage for restart after momentary power failure, the inverter recognizes that the power has been shut down so that it does not restart but starts (normal starting).

Allowable voltage for restart after momentary power failure

Power supply	Allowable voltage for restart after momentary power failure
200 V series	50 V
400 V series	100 V

Note The time required from when the DC link bus voltage drops from the threshold of undervoltage until it reaches the allowable voltage for restart after momentary power failure, greatly varies depending on the inverter capacity, the presence of options, and other factors.

■ Auto-restart after a recovery from momentary power failure (waiting time) (H13)

This function specifies the time period from momentary power failure occurrence until the inverter reacts for restarting process.

If the inverter starts the motor while motor's residual voltage is still in a high level, a large inrush current may flow or an overvoltage alarm may occur due to an occurrence of temporary regeneration. For safety, therefore, it is advisable to set H13 to a certain level so that restart will take place only after the residual voltage has dropped to a low level. Note that even when power is recovered, restart will not take place until the waiting time (H13) has elapsed.

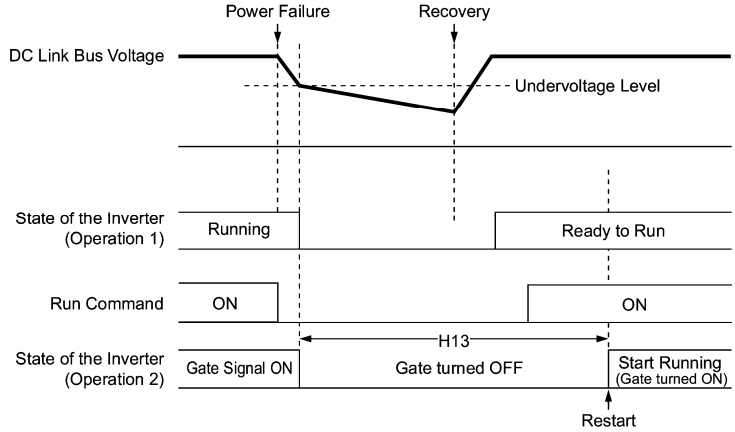

■ Factory default

By factory default, H13 is set at one of the values shown below according to the inverter capacity. Basically, you do not need to change H13 data. However, if the long waiting time causes the flow rate of the pump to overly decrease or causes any other problem, you might as well reduce the setting to about a half of the default value. In such a case, make sure that no alarm occurs.

Inverter capacity (kW)	Factory default of H13 (Restart time in seconds)
0.1 to 7.5	0.5
11 to 37	1.0
45 to 110	1.5
132 to 160	2.0
200 to 280	2.5
315 to 355	4.0
400 to 500	5.0

Note Function code H13 (Restart mode after momentary power failure -- Restart time) also applies to the switching operation between line and inverter (refer to E01 through E05; terminals [X1] through [X5]).

■ Restart after momentary power failure (Frequency fall rate) (H14)

During restart after a momentary power failure, if the inverter output frequency and the motor rotation cannot be harmonized with each other, an overcurrent will flow, activating the overcurrent limiter. If it happens, the inverter reduces the output frequency to match the motor rotation according to the reduction rate (Frequency fall rate: Hz/s) specified by H14.

Data for H14	Inverter's action on the frequency fall rate
0.00	Follow the deceleration time specified by F08
0.01 to 100.00 Hz/s	Follow data specified by H14
999	Follow the setting of the PI controller in current limiter (The PI constant is prefixed inside the inverter.)

Note If the frequency fall rate is too high, regeneration may take place at the moment the motor rotation matches the inverter output frequency, causing an overvoltage trip. On the contrary, if the frequency fall rate is too low, the time required for the output frequency to match the motor speed (duration of current limiting action) may be prolonged, triggering the inverter overload prevention control.

F15 Frequency Limiter (High)
F16 Frequency Limiter (Low)

F15 and F16 specify the upper and lower limits of the output frequency, respectively.

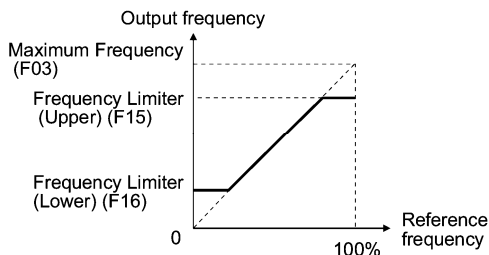

- Note**
- When you change the frequency limiter (High) (F15) in order to raise the running frequency, be sure to change the maximum frequency (F03) accordingly.
 - Maintain the following relationship among the data for frequency control:
 $F15 > F16$, $F15 > F23$, and $F15 > F25$
 $F03 > F16$

where, F23 is of the starting frequency and F25 is of the stop frequency.

If you specify any wrong data for these function codes, the inverter may not run the motor at the desired speed, or cannot start it normally.

F18, C50	Bias, Bias Reference Point	(Frequency command 1)
C32, C34	Analog Input Adjustment for [12]	(Gain, Gain reference point)
C37, C39	Analog Input Adjustment for [C1]	(Gain, Gain reference point)
C42, C44	Analog Input Adjustment for [V2]	(Gain, Gain reference point)

When any analog input for frequency command 1 (F01) is used, it is possible to define the relationship between the analog input and the reference frequency by multiplying the gain and adding the bias specified by F18.

As shown in the graph below, the relationship between the analog input and the reference frequency specified by frequency command 1 is determined by points "A" and "B." Point "A" is defined by the combination of the bias (F18) and its reference point (C50); Point B, by the combination of the gain (C32, C37 or C42) and its reference point (C34, C39 or C44).

The combination of C32 and C34 applies to terminal [12], that of C37 and C39, to [C1], and that of C42 and C44, to [V2].

Configure the bias (F18) and gain (C32, C37 or C42), assuming the maximum frequency as 100%, and the bias reference point (C50) and gain reference point (C34, C39 or C44), assuming the full scale (10 VDC or 20 mA DC) of analog input as 100%.

- Note**
- The analog input less than the bias reference point (C50) is limited by the bias value (F18)
 - Specifying that the data of the bias reference point (C50) is equal to or greater than that of each gain reference point (C34, C39 or C44) will be interpreted as invalid, so the inverter will reset the reference frequency to 0 Hz.

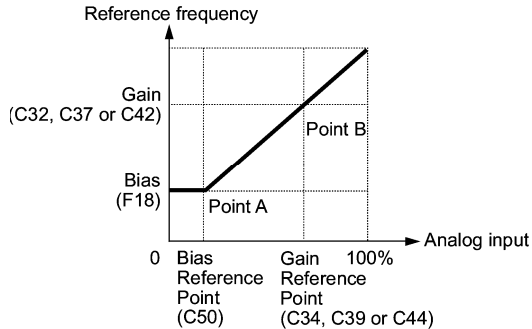

Example: Setting the bias, gain and its reference points when the reference frequency 0 to 100% follows the analog input of 1 to 5 VDC to terminal [12] (in frequency command 1).

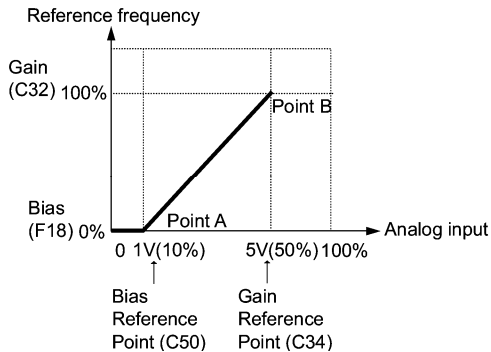

(Point A)

To set the reference frequency to 0 Hz for an analog input being at 1 V, set the bias to 0% (F18 = 0). Since 1 V is the bias reference point and it is equal to 10% of 10 V, set the bias reference point to 10% (C50 = 10).

(Point B)

To make the maximum frequency equal to the reference frequency for an analog input being at 5 V, set the gain to 100% (C32 = 100). Since 5 V is the gain reference point and it is equal to 50% of 10 V, set the gain reference point to 50% (C34 = 50).

Note The setting procedure for specifying a gain or bias alone without changing any reference points is the same as that of Fuji conventional inverters of FRENIC5000G11S/P11S series, FVR-E11S series, etc.

F20 to F22 DC Braking (Braking start frequency, Braking level, and Braking time)
H95 DC Braking (Braking response mode)

F20 through F22 specify the DC braking that prevents the motor from running by inertia during deceleration-to-stop operation

If the motor enters a deceleration-to-stop operation by turning off the run command or by decreasing the reference frequency below the stop frequency, the inverter activates the DC braking by flowing a current at the braking level (F21) during the braking time (F22) when the output frequency reaches the DC braking start frequency (F20).

Setting the braking time to "0.0" (F22 = 0) disables the DC braking.

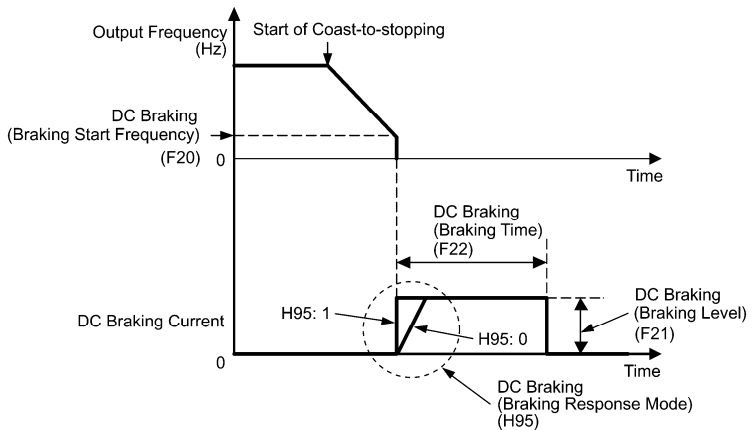

Tip It is also possible to use an external digital input signal as a DC braking command (DCBRK).

As long as the (DCBRK) command is ON, the inverter performs DC braking, regardless of the braking time specified by F22.

Turning the (DCBRK) command ON even when the inverter is in a stopped state activates DC braking. This feature allows the motor to be excited before starting, resulting in smoother acceleration (quicker build-up of acceleration torque).

Note In general, specify data of the function code F20 at a value close to the rated slip frequency of motor. If you set it at an extremely high value, control may become unstable and an overvoltage alarm may result in some cases.

⚠ CAUTION

The DC brake function of the inverter does not provide any holding mechanism.
Injuries could occur.

F23 Starting Frequency
 F25 Stop Frequency

At the startup of an inverter, the initial output frequency is equal to the starting frequency. The inverter stops its output at the stop frequency.

Set the starting frequency to a level that will enable the motor to generate enough torque for startup. Generally, set the motor's rated slip frequency at the starting frequency F23.

Note If the starting frequency is lower than the stop frequency, the inverter will not output any power as long as the frequency command does not exceed the stop frequency.

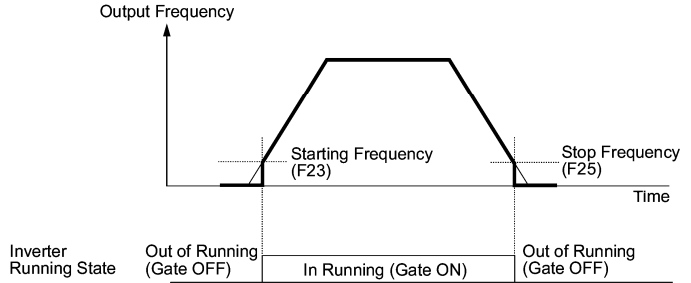

F26 Motor Sound (Carrier frequency)
 F27 Motor Sound (Tone)

■ Motor sound (Carrier frequency) (F26)

F26 controls the carrier frequency so as to reduce an audible noise generated by the motor or inverter itself, and to decrease a leakage current from the main output (secondary) wirings.

Carrier frequency	Inverter rated capacity: 0.75 to 22 kW	0.75 to 15 kHz
	Inverter rated capacity: 30 to 75 kW	0.75 to 10 kHz
	Inverter rated capacity: 90 to 500 kW	0.75 to 6 kHz
Motor sound noise emission		High ↔ Low
Motor temperature (due to harmonics components)		High ↔ Low
Ripples in output current waveform		Large ↔ Small
Leakage current		Low ↔ High
Electromagnetic noise emission		Low ↔ High
Inverter loss		Low ↔ High

Note Specifying a too low carrier frequency will cause the output current waveform to have a large amount of ripples (many harmonics components). As a result, the motor loss increases, causing the motor temperature to rise. Furthermore, the large amount of ripples tends to cause a current limiting alarm. When the carrier frequency is set to 1 kHz or below, therefore, reduce the load so that the inverter output current comes to be 80% or less of the rated current.

When a high carrier frequency is specified, the temperature of the inverter may rise due to an ambient temperature rise or an increase of the load. If it happens, the inverter automatically decreases the carrier frequency to prevent the inverter overheat alarm *OH* or inverter overload alarm *OL*. With consideration for motor noise, the automatic reduction of carrier frequency can be disabled (see function code H98).

■ Motor sound (Tone) (F27)

F12 changes the motor running sound tone. This setting is effective when the carrier frequency set to function code F26 is 7 kHz or lower. Changing the tone level may reduce the high and harsh running noise from the motor.

Data for F27	Function
0	Disable (Tone level 0)
1	Enable (Tone level 1)
2	Enable (Tone level 2)
3	Enable (Tone level 3)

Note If the sound level is set too high, the output current may become unstable, or mechanical vibration and noise may increase. Also, these function codes may not be very effective for certain types of motor.

F29	Analog Output [FMA] (Mode selection)
F30	(Output adjustment)
F31	(Function)

These function codes allow you to output to terminal [FMA] monitored data such as the output frequency and the output current in the form of an analog DC voltage or current. The magnitude of such analog voltage or current is adjustable.

■ Mode selection (F29)

F29 specifies the property of the output to terminal [FMA]. You need to set switch SW4 on the control PCB accordingly, referring to the table below.

Data for F29	Output form	Positioning slide switch (SW4) mounted on the control PCB
0	Voltage (0 to +10 VDC)	VO
1	Current (+4 to +20 mA DC)	IO

Note The current output is not isolated from the analog input and does not have its own independent power source. Therefore, this output must not be connected in cascade to outside instrument and gauges if some difference in potential is there between the inverter and peripheral equipment regarding connection of analog input etc. Avoid needlessly long wiring.

■ Output adjustment (F30)

F30 allows you to adjust the output voltage or current representing the monitored data selected by function code F31 within the range of 0 to 200%.

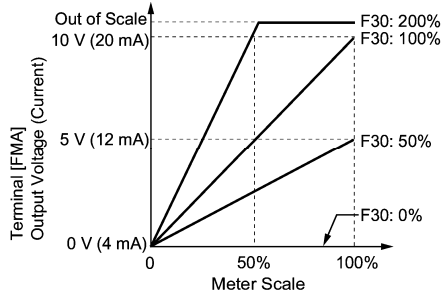

■ Function (F31)

F31 specifies what is output to the analog output terminal [FMA].

Data for F31	[FMA] output	Function (Monitor the following)	Meter scale (Full scale at 100%)
0	Output frequency	Output frequency of the inverter	Maximum frequency (F03)
2	Output current	Output current (RMS) of the inverter	Twice the inverter rated current
3	Output voltage	Output voltage (RMS) of the inverter	250 V for 200 V series, 500 V for 400 V series
4	Output torque	Motor shaft torque	Twice the rated motor torque
5	Load factor	Load factor (Equivalent to the indication of the load meter)	Twice the rated motor load, or <ul style="list-style-type: none"> Rated output torque of the motor at the base frequency or below Rated motor output (kW) at the base frequency or above
6	Input power	Input power of the inverter	Twice the rated output of the inverter
7	PID feedback value (PV)	Feedback value under PID control	100% of the feedback value
9	DC link bus voltage	DC link bus voltage of the inverter	500 V for 200 V series, 1000 V for 400 V series
10	Universal AO	Command via communications link (Refer to the RS485 Communications User's Manual (MEH448a))	20,000 as 100%
13	Motor output	Motor output (kW)	Twice the rated motor output
14	Calibration analog output (+)	Full scale output of the meter calibration	10 VDC or 20 mA DC
15	PID process command (SV)	Process command under PID control	100% of the feedback value
16	PID process output (MV)	Output level of the PID controller under PID control (Frequency command)	Maximum frequency (F03)

F33	Pulse Output [FMP] (Pulse rate)
F34	(Duty)
F35	(Function)

The control PCB is equipped with either a screw terminal base or Europe type terminal block, supporting [FMP] or [FMI], respectively. The [FMP] enables F33 to F35, but the [FMI] enables only F34 and F35 so that F33 will not appear.

For [FMP]

These function codes allow you to output to terminal [FMP] monitored data such as the output frequency and the output current in the form of a variable rate pulse train or a These function codes allow you to output monitored data (such as the output frequency and the output current) to terminal [FMP] in the form of a variable rate pulse train or a fixed rate pulse train. The fixed rate pulse train (whose pulse duty control produces a variance of an average output voltage of the train) can be used to drive an analog meter.

The output pulse can be specified for each of monitored data items.

To use this terminal for pulse output, set F33 to an appropriate value and set F34 to "0."

To use this terminal for fixed rate pulse train output, set F34 within the range from 1 to 200%. This setting causes the setting of F33 to be ignored.

■ Pulse rate (F33)

F33 specifies the number of pulses at which the output of the set monitored item reaches 100%, in accordance with the specifications of the counter to be connected.

■ Duty (F34)

Data for F34	[FMP] output	Pulse duty	Pulse rate	Connected equipment (Example)
0	Pulse train	Around 50%	Variable	Pulse counter
1 to 200%	Fixed rate pulse train	Variable	2000 p/s	Analog meter

F34 allows you to scale the average voltage corresponding to full scale of the monitored item selected by function code F35 within the range of 1 to 200 (%) where 100% stands on a half cycle of a square wave pulse in the train.

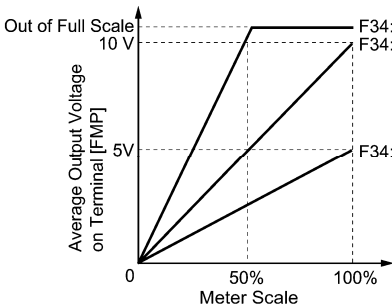

• Pulse train output waveform

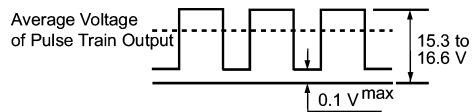

• FMP output circuit

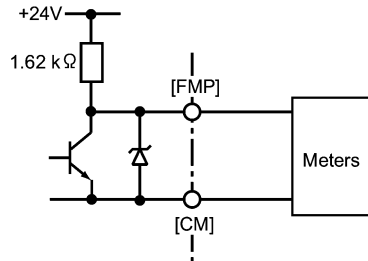

For the voltage specifications of the pulse output, refer to Chapter 2 "MOUNTING AND WIRING OF THE INVERTER."

■ Function (F35)

F35 selects the item (object) to monitor and to output to the [FMP] terminal. Those contents, and amounts (Definition of 100%) are the same as those for function code F31. Refer to the table in function code F31.

For [FMI]

The inverter outputs monitoring data including output frequency and output current via terminal [FMI] in analog current level.

■ Voltage adjust (F34)

Setting this function code adjusts the output current level of the selected monitor item within 0 to 200% as well as the function code F30.

■ Function (F35)

Setting this function code selects a monitor item to be output to terminal [FMI] as well as the function code F31.

E01 to E05	Command Assignment to [X1] to [X5]
E98, E99	Command Assignment to [FWD] and [REV]

Function codes E01 to E05, E98 and E99 allow you to assign commands to terminals [X1] to [X5], [FWD], and [REV] which are general-purpose, programmable input terminals.

These function codes may also switch the logic system between normal and negative to define how the inverter logic interprets either ON or OFF status of each terminal. The default setting is normal logic system "Active ON." So, explanations that follow are given in normal logic system "Active ON."

 **CAUTION**

In the case of digital input, you can assign commands to the switching means for the run command and its operation, the reference frequency and the motor drive power (e.g., (SS1), (SS2), (SS4), (Hz2/Hz1), (SW50), (SW60), (Hz/PID), (IVS), (LE), (LOC), and (FR2/FR1)). Be aware of that switching of any of such signals may cause a sudden start (running) or an abrupt change in speed.

An accident or physical injury may result.

Function code data		Terminal commands assigned	Symbol
Active ON	Active OFF		
0	1000	Select multistep frequency	(SS1)
1	1001		(SS2)
2	1002		(SS4)
6	1006	Enable 3-wire operation	(HLD)
7	1007	Coast to a stop	(BX)
8	1008	Reset alarm	(RST)
1009	9	Enable external alarm trip	(THR)
11	1011	Switch frequency command 2/1	(Hz2/Hz1)
13	—	Enable DC brake	(DCBRK)
15	—	Switch to commercial power (50 Hz)	(SW50)
16	—	Switch to commercial power (60 Hz)	(SW60)
17	1017	UP (Increase output frequency)	(UP)
18	1018	DOWN (Decrease output frequency)	(DOWN)
19	1019	Enable write from keypad (Data changeable)	(WE-KP)
20	1020	Cancel PID control	(Hz/PID)
21	1021	Switch normal/inverse operation	(IVS)
22	1022	Interlock	(IL)
24	1024	Enable communications link via RS485 or field bus (op-	(LE)
25	1025	Universal DI	(U-DI)
26	1026	Select starting characteristics	(STM)
1030	30	Force to stop	(STOP)
33	1033	Reset PID integral and differential components	(PID-RST)
34	1034	Hold PID integral component	(PID-HLD)
35	1035	Select local (keypad) operation	(LOC)
38	1038	Enable to run	(RE)
39	—	Protect motor from dew condensation	(DWP)
40	—	Enable integrated sequence to switch to commercial power (50 Hz)	(ISW50)
41	—	Enable integrated sequence to switch to commercial power (60 Hz)	(ISW60)
50	1050	Clear periodic switching time	(MCLR)
51	1051	Enable Pump Drive (Motor 1 to 4)	(MEN1)
52	1052		(MEN2)
53	1053		(MEN3)
54	1054		(MEN4)
87	1087	Switch run command 2/1	(FR2/FR1)
88	—	Run forward 2	(FWD2)
89	—	Run reverse 2	(REV2)
98	—	Run forward (Exclusively assigned to [FWD] and [REV])	(FWD)
99	—	Run reverse (Exclusively assigned to [FWD] and [REV])	(REV)

Note Any negative logic (Active off) command cannot be assigned to the functions marked with "—" in the "Active OFF" column.

The "Enable external alarm trip" and "Force to stop" are fail-safe terminal commands. For example, when data = "9" in "Enable external alarm trip," Active OFF (alarm is triggered when OFF); when data = 1009, "Active ON" (alarm is triggered when ON).

- Select multistep frequency (1 to 7 steps) – (SS1), (SS2), and (SS4)
(Function code data = 0, 1, and 2)

The combination of ON/OFF states of digital input signals (SS1), (SS2) and (SS4) selects one of eight different frequency commands defined beforehand by seven function codes C05 to C11 (Multistep frequency 1 to 7). With this, the inverter can drive the motor at 8 different preset speeds.

The table below lists the frequencies that can be obtained by the combination of switching (SS1), (SS2), and (SS4). In the "Selected frequency" column, "Other than multistep frequency" represents the reference frequency commanded by frequency command 1 (F01), frequency command 2 (C30), or others.

Terminal [X3] (Function code E03)	Terminal [X2] (Function code E02)	Terminal [X1] (Function code E01)	Selected frequency
2 (SS4)	1 (SS2)	0 (SS1)	
OFF	OFF	OFF	Other than multistep frequency
OFF	OFF	ON	C05 (Multistep frequency 1)
OFF	ON	OFF	C06 (Multistep frequency 2)
OFF	ON	ON	C07 (Multistep frequency 3)
ON	OFF	OFF	C08 (Multistep frequency 4)
ON	OFF	ON	C09 (Multistep frequency 5)
ON	ON	OFF	C10 (Multistep frequency 6)
ON	ON	ON	C11 (Multistep frequency 7)

- Enable 3-wire operation -- (HLD)
(Function code data = 6)

Turning this terminal command ON self-holds the forward (FWD) or reverse (REV) run command issued with it, to enable 3-wire operation.

Turning (HLD) ON self-holds the first (FWD) or (REV) command at its leading edge. Turning (HLD) OFF releases the self-holding.

When (HLD) is not assigned, 2-wire operation involving only (FWD) and (REV) takes effect.

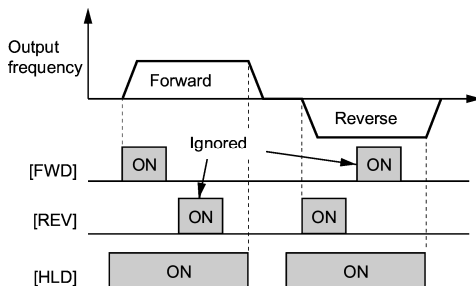

- Coast to a stop -- (BX)
(Function code data = 7)

Turning (BX) ON will immediately stop and the motor will enter the coast to a stop operation without issuing any alarms.

- Reset alarm -- (RST)
(Function code data = 8)

Turning this terminal command ON clears the (ALM) state--alarm output (for any fault). Turning it OFF erases the alarm display and clears the alarm hold state.

When you turn the (RST) command ON, keep it ON for 10 ms or more. This command should be kept OFF for the normal inverter operation.

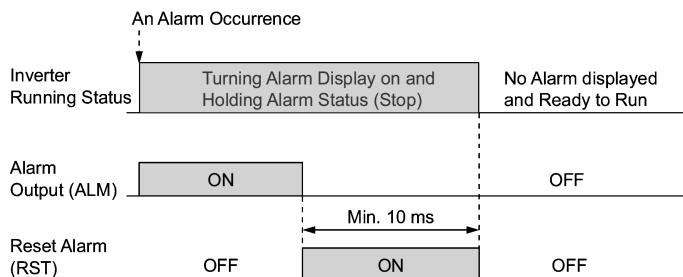

- Enable external alarm trip -- (THR)
(Function code data = 9)

Turning this terminal command OFF immediately shuts down the inverter output (so that the motor coasts to stop), displays the alarm $\overline{O-Hz}$, and outputs the alarm relay (for any fault) (ALM). The (THR) is self-held, and is reset when an alarm reset takes place.

Tip Use a trip command from external equipment when you have to immediately shut down the inverter output in the event of an abnormal situation in peripheral equipment.

- Switch frequency command 2/1 -- (Hz2/Hz1)
(Function code data = 11)

Turning this digital input signal ON and OFF switches the frequency command source between frequency command 1 (Hz1: F01) and frequency command 2 (Hz2: C30).

If nothing is assigned to this terminal command, the frequency specified by F01 takes effect by default.

Frequency command (Hz2/Hz1)	Frequency command source
OFF	Follow F01 (Frequency command 1)
ON	Follow C30 (Frequency command 2)

- Enable DC brake -- (DCBRK)
(Function code data = 13)

Turning this terminal command ON activates the DC braking. As long as this command remains ON, the DC braking is working regardless of the braking time specified by F22. Furthermore, turning this command ON even when the inverter is in a stopped state activates DC braking. This feature allows the motor to be excited before starting, resulting in smoother acceleration (quicker build-up of acceleration torque).

Note For details, refer to the description of F20 to F22.

- Enable write from keypad -- (WE-KP)
(Function code data = 19)

Turning this terminal command OFF disables changing of function code data from the keypad.

Only when this command is ON, you can change function code data from the keypad according to the setting of function code F00 as listed below.

(WE-KP)	F00	Function
OFF	Disable	Disable editing of all function code data except that of F00.
ON	0	Enable editing of all function code data
	1	Inhibit editing of all function code data except that of F00

If the (WE-KP) command is not assigned to any terminal, the inverter will interpret (WE-KP) to be always ON by default.

Note If you mistakenly assign a (WE-KP) command to a terminal, you cannot edit or modify function code data anymore. In such a case, temporarily turn on the (WE-KP)-assigned terminal and then reassign the (WE-KP) command to a correct terminal.

- Switch normal/inverse operation -- (IVS)
(Function code data = 21)

This terminal command switches the output frequency control between normal (proportional to the input value) and inverse in PID process control and manual frequency command. To select the inverse operation, turn the (IVS) command ON.

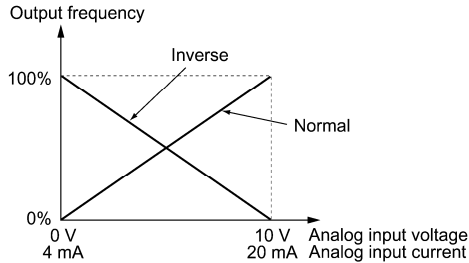

Tip The normal/inverse switching operation is useful for air-conditioners that require switching between cooling and heating. In cooling, the speed of the fan motor (output frequency of the inverter) is increased to lower the temperature. In heating, it is reduced to lower the temperature. This switching is realized by the "Switch normal/inverse operation" command.

For details of PID control, refer to the FRENIC-Eco User's Manual (MEH456), Chapter 4, Section 4.9 "PID Frequency Command Generator" and Chapter 9, Section 9.2.6 "J codes."

- When the inverter is driven by an external analog frequency command sources (terminals [12], [C1], and [V2]):

The "Switch normal/inverse operation" command (IVS) can apply only to the analog frequency command sources (terminals [12], [C1] and [V2]) in frequency command 1 (F01) and does not affect frequency command 2 (C30) or UP/DOWN control.

As listed below, the combination of the "Selection of normal/inverse operation for frequency command 1" (C53) and "Switch normal/inverse operation" (IVS) determines the final operation.

Combination of C53 and (IVS)

Data for C53	(IVS)	Final operation
0: Normal operation	OFF	Normal
	ON	Inverse
1: Inverse operation	OFF	Inverse
	ON	Normal

■ Interlock -- (IL)

(Function code data = 22)

In a configuration where a magnetic contactor (MC) is installed in the power output (secondary) circuit of the inverter, the momentary power failure detection feature provided inside the inverter may not be able to accurately detect a momentary power failure by itself. Using a digital signal input with the interlock command (IL) assures the accurate detection

(IL)	Meaning
OFF	No momentary power failure has occurred.
ON	A momentary power failure has occurred. (Restart after a momentary power failure enabled)

 For details of operation after a recovery from momentary power failure, refer to the description of function code F14.

■ Enable communications link via RS485 or field bus (option) -- (LE)

(Function code data = 24)

Turning this terminal command ON assigns priorities to frequency commands or run commands received via the RS485 communications link (H30) or the field bus option (y98).

No (LE) assignment is functionally equivalent to the (LE) being ON.

 For details of switching, refer to H30 (Communications link function) and y98 (Bus link function).

- Universal DI -- (U-DI)
(Function code data = 25)

Using (U-DI) enables the inverter to monitor digital signals sent from the peripheral equipment via an RS485 communications link or a field bus option by feeding those signals to the digital input terminals. Signals assigned to the universal DI are simply monitored and do not operate the inverter.

 For an access to universal DI via the RS485 or field bus communications link, refer to their respective Instruction Manuals.

- Select starting characteristics -- (STM)
(Function code data = 26)

This digital terminal command determines, at the start of operation, whether or not to search for idling motor speed and follow it.

 For details of auto search for idling motor speed, refer to H09 and H17 (Select starting characteristics).

- Force to stop -- (STOP)
(Function code data = 30)

Turning this terminal command OFF causes the motor to decelerate to a stop during the time specified by H56 (Deceleration time for forced stop). After the motor stops, the inverter enters the alarm state with alarm E-5. Apply this command to a failsafe facility.

- Select local (keypad) operation -- (LOC)
(Function code data = 35)

This terminal command switches the source of the run command and frequency command between remote and local by an external digital input signal.

 For details of the local mode, refer to "[Switching between remote and local modes](#)" in Chapter 3, Section 3.3.3.

- Protect motor from dew condensation -- (DWP)
(Function code data = 39)

Turning this terminal command ON supplies a DC current to the motor that is on halt in order to generate heat, preventing dew condensation.

 For details of dew condensation protection, refer to function code J21 (Dew condensation prevention (Duty)).

- Switch run command 2/1 -- (FR2/FR1)
Run forward 2 and Run reverse 2 -- (FWD2) and (REV2)
(Function code data = 87, 88 or 89)

These terminal commands switch the run command source. They are useful to switch the source between the digital input and the local keypad when the "Enable communications link" command (LE) and "Select local (keypad) operation" command (LOC) are turned OFF.

 Refer to the FRENIC-Eco User's Manual (MEH456), Chapter 4, Section 4.3 "Drive Command Generator" for details.

(FR2/FR1)	Run command source	
	Communications link disabled (Normal operation)	Communications link enabled
OFF	Follow the data of F02	Follow the data of S06 (FWD/REV)
ON	(FWD2) or (REV2)	Follow the data of S06 (FWD2/REV2)

Turning the (FWD2) command ON runs the motor forward, and turning the (REV2) command, reverse. Turning either of them OFF decelerates the motor to stop.

- Run forward -- (FWD)
(Function code data = 98)

Turning this terminal command ON runs the motor in the forward direction; turning it OFF decelerates it to stop.

 This terminal command can be assigned only by E98 or E99.

- Run reverse -- (REV)
(Function code data = 99)

Turning this terminal command ON runs the motor in the reverse direction; turning it OFF decelerates it to stop.

 This terminal command can be assigned only by E98 or E99.

E20 to E22	Signal Assignment to [Y1] to [Y3] (Transistor signal)
E24, E27	Signal Assignment to [Y5A/C] and [30A/B/C] (Relay contact signal)

E20 to E22, E24, and E27 assign output signals (listed on the next page) to general-purpose, programmable output terminals [Y1], [Y2], [Y3], [Y5A/C], and [30A/B/C]. These function codes can also switch the logic system between normal and negative to define the property of those output terminals so that the inverter logic can interpret either the ON or OFF status of each terminal as active. The factory default settings are "Active ON."

Terminals [Y1], [Y2], and [Y3] are transistor outputs and terminals [Y5A/C] and [30A/B/C] are relay contact outputs. In normal logic, if an alarm occurs, the relay will be energized so that [30A] and [30C] will be closed, and [30B] and [30C] opened. In negative logic, the relay will be deenergized so that [30A] and [30C] will be opened, and [30B] and [30C] closed. This may be useful for the implementation of failsafe power systems.



- When a negative logic is employed, all output signals are active (e.g. an alarm would be recognized) while the inverter is powered OFF. To avoid causing system malfunctions by this, interlock these signals to keep them ON using an external power source. Furthermore, the validity of these output signals is not guaranteed for approximately 3 seconds after power-on, so introduce such a mechanism that masks them during the transient period.
- Terminals [Y5A/C] and [30A/B/C] use mechanical contacts that cannot stand frequent ON/OFF switching. Where a frequent ON/OFF switching is anticipated (for example, limiting a current by using signals subjected to inverter output limit control such as switching to commercial power line), use transistor outputs [Y1] through [Y3] instead. The service life of a relay is approximately 200,000 times if it is switched on and off at one-second intervals.

The table below lists functions that can be assigned to terminals [Y1], [Y2], [Y3], [Y5A/C], and [30A/B/C].

To make the explanations simpler, the examples shown below are all written for the normal logic (Active ON.)

Function code data		Functions assigned	Symbol
Active ON	Active OFF		
0	1000	Inverter running	(RUN)
1	1001	Frequency arrival signal	(FAR)
2	1002	Frequency detected	(FDT)
3	1003	Undervoltage detected (Inverter stopped)	(LU)
5	1005	Inverter output limiting	(IOL)
6	1006	Auto-restarting after momentary power failure	(IPF)
7	1007	Motor overload early warning	(OL)
10	1010	Inverter ready to run	(RDY)
11	-	Switch motor drive source between commercial power and inverter output (For MC on commercial line)	(SW88)
12	-	Switch motor drive source between commercial power and inverter output (For primary side)	(SW52-2)
13	-	Switch motor drive source between commercial power and inverter output (For secondary side)	(SW52-1)
15	1015	Select AX terminal function (For MC on primary side)	(AX)
25	1025	Cooling fan in operation	(FAN)
26	1026	Auto-resetting	(TRY)
27	1027	Universal DO	(U-DO)
28	1028	Heat sink overheat early warning	(OH)
30	1030	Service life alarm	(LIFE)
33	1033	Command loss detected	(REF OFF)
35	1035	Inverter output on	(RUN2)
36	1036	Overload prevention control	(OLP)
37	1037	Current detected	(ID)
42	1042	PID alarm	(PID-ALM)
43	1043	Under PID control	(PID-CTL)
44	1044	Motor stopping due to slow flowrate under PID control	(PID-STP)
45	1045	Low output torque detected	(U-TL)
54	1054	Inverter in remote operation	(RMT)
55	1055	Run command activated	(AX2)
56	1056	Motor overheat detected (PTC)	(THM)
59	1059	Terminal [C1] wire break *	(C1OFF)
60	1060	Mount motor 1, inverter-driven	(M1_I)
61	1061	Mount motor 1, commercial-power-driven	(M1_L)
62	1062	Mount motor 2, inverter-driven	(M2_I)
63	1063	Mount motor 2, commercial-power-driven	(M2_L)
64	1064	Mount motor 3, inverter-driven	(M3_I)
65	1065	Mount motor 3, commercial-power-driven	(M3_L)
67	1067	Mount motor 4, commercial-power-driven	(M4_L)
68	1068	Periodic switching early warning	(MCHG)
69	1069	Pump control limit signal	(MLIM)
99	1099	Alarm output (for any alarm)	(ALM)

* Available for inverters having a ROM version 1400 or later.



A mark "-" in the Active OFF column means that a negative logic cannot be applied to the terminal function.

- Inverter running -- (RUN)
(Function code data = 0)

This output signal is used to tell the external equipment that the inverter is running at a starting frequency or higher. It comes ON when the output frequency exceeds the starting frequency, and it goes OFF when it is less than the stop frequency. It is also OFF when the DC braking is in operation.

If this signal is assigned in negative logic (Active OFF), it can be used as a signal indicating "inverter being stopped."

- Frequency arrival signal -- (FAR)
(Function code data = 1)

This output signal comes ON when the difference between the output frequency and reference frequency comes within the allowable error zone. (prefixed to 2.5 Hz).

- Frequency detected -- (FDT)
(Function code data = 2)

This output signal comes ON when the output frequency exceeds the frequency detection level specified by E31, and it goes OFF when the output frequency drops below the "Frequency detection level (E31) - Hysteresis width (E32)." To utilize this feature, you need to assign **FDT** (data = 2) to any of digital output terminals.

- Undervoltage detected -- (LU)
(Function code data = 3)

This output signal comes ON when the DC link bus voltage of the inverter drops below the specified undervoltage level, and it goes OFF when the voltage exceeds the level.

This signal is ON also when the undervoltage protective function is activated so that the motor is in an abnormal stop state (e.g., tripped).

When this signal is ON, a run command is disabled if given.

- Inverter output limiting -- (IOL)
(Function code data = 5)

This output signal comes ON when the inverter is limiting the output frequency by activating any of the following actions (minimum width of the output signal: 100 ms).

- Current limiting by software (F43 and F44: Current limiter (Mode selection) and (Level))
- Instantaneous overcurrent limiting by hardware (H12 = 1)
- Automatic deceleration (H69 = 3))

 **Note** When the (IOL) signal is ON, it may mean that the output frequency may have deviated from (or dropped below) the frequency specified by the frequency command because of this limiting function.

- Auto-restarting after momentary power failure -- (IPF)
(Function code data = 6)

This output signal is ON either during continuous running after a momentary power failure or during the period from when the inverter has detected an undervoltage condition and shut down the output until restart has been completed (the output has reached the reference frequency).

To enable this (IPF) signal, set F14 (Restart mode after momentary power failure) to "3: Enable restart (Continue to run)," "4: Enable restart (Restart at the frequency at which the power failure occurred)," or "5: Enable restart (Restart at the starting frequency)" beforehand.

- Motor overload early warning -- (OL)
(Function code data = 7)

This output signal is used to issue a motor overload early warning that enables you to take an corrective action before the inverter detects a motor overload alarm \overline{OL} and shuts down its output.

This signal comes ON when the current exceeds the level specified by E34 (Overload early warning).

Note Function code E34 is effective for not only the (OL) signal, but also for the "Current detected" signal (ID).

- Inverter ready to run -- (RDY)
(Function code data = 10)

This output signal comes ON when the inverter becomes ready to run by completing hardware preparation (such as initial charging of DC link bus capacitors and initialization of the control circuit) and no protective functions are activated.

- Select AX terminal function -- (AX)
(Function code data = 15)

In response to a run command (FWD), this output signal controls the magnetic contactor on the commercial-power supply side. It comes ON when the inverter receives a run command and it goes OFF after the motor decelerates to stop because of a stop command received.

This signal immediately goes OFF upon receipt of a coast-to-stop command or when an alarm occurs.

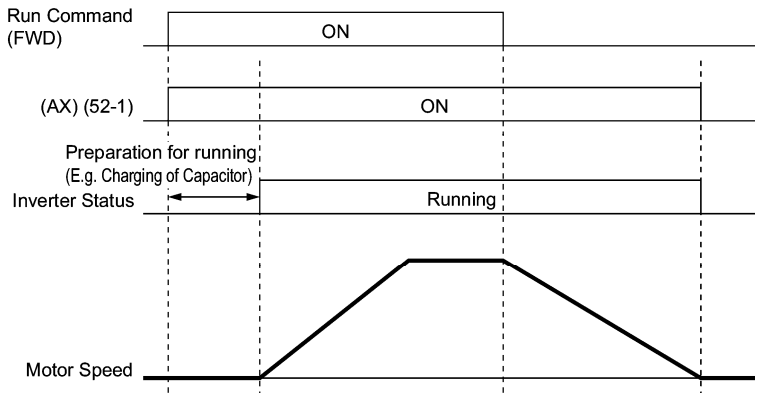
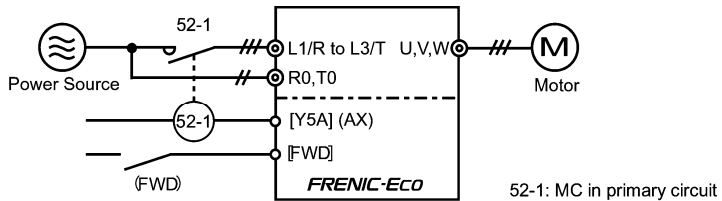

- Cooling fan in operation -- (FAN)
(Function code data = 25)

Under the cooling fan ON/OFF control enabled (H06 = 1), this output signal is ON when the cooling fan is in operation, and OFF when it is stopped. This signal can be used to make the cooling system of peripheral equipment interlocked for an ON/OFF control.

- Auto-resetting -- (TRY)
(Function code data = 26)

This output signal comes ON when auto resetting is in progress. The auto-resetting is specified by H04 and H05 (Auto-resetting). Refer to function codes H04 and H05 for details about the number of resetting times and reset interval.

- Universal DO -- (U-DO)
(Function code data = 27)

Assigning this output signal to an inverter's output terminal and connecting the terminal to a digital input terminal of peripheral equipment via the RS485 communications link or the field bus, allows the inverter to send commands to the peripheral equipment.

The universal DO can be used as an output signal independent of the inverter operation.

 For the procedure for access to Universal DO via the RS485 communications link or field bus, refer to the respective instruction manual.

- Heat sink overheat early warning -- (OH)
(Function code data = 28)

This output signal is used to issue a heat sink overheat early warning that enables you to take a corrective action before an overheat trip \overline{OH} / actually happens.

This signal comes ON when the temperature of the heat sink exceeds the "overheat trip \overline{OH} / temperature minus 5°C," and it goes OFF when it drops down to the "overheat trip \overline{OH} / temperature minus 8°C."

This signal comes ON also when the internal air circulation DC fan (45 kW or above for 200V series or 55 kW or above for 400V series) has locked.

- Service life alarm -- (LIFE)
(Function code data = 30)

This output signal comes ON when it is judged that the service life of any one of electrolytic capacitors on the PCBs, DC link bus capacitor and cooling fan has expired.

This signal comes ON also when the internal air circulation DC fan (45 kW or above for 200V series or 55 kW or above for 400V series) has locked.

This signal should be used as a guide for replacement of the capacitors and cooling fan. If this signal comes ON, use the specified maintenance procedure to check the service life of these parts and determine whether the parts should be replaced or not.

 For details, refer to Section 7.3, Table 7.3 "Criteria for Issuing a Lifetime Alarm."

- Command loss detected -- (REF OFF)
(Function code data = 33)

This output signal comes ON when an analog input used as a frequency command source is in a command loss state (as specified by E65) due to a wire break or a weak connection. This signal goes OFF when the operation under the analog input is resumed.

 For details of the command loss detection, refer to the descriptions of function code E65.

- Inverter output on -- (RUN2)
(Function code data = 35)

This output signal comes ON when the inverter is running at the starting frequency or below or the DC braking is in operation.

- Overload prevention control -- (OLP)
(Function code data = 36)

This output signal comes ON when the overload prevention control is activated. The minimum ON-duration is 100 ms.

 For details of the overload prevention control, refer to the descriptions of function code H70.

- Current detected -- (ID)
(Function code data = 37)

This output signal comes ON when the output current of the inverter exceeds the level specified by E34 (Current detection (Level)) for the time longer than the one specified by E35 (Current detection (Timer)). The minimum ON-duration is 100 ms.

This signal goes OFF when the output current drops below 90% of the rated operation level.

 **Note** Function code E34 is effective for not only the motor overload early warning (OL), but also for the operation level of the current detection (ID).

 For details of the current detection, refer to the descriptions of function codes E34 and E35.

- Low output torque detected -- (U-TL)
(Function code data = 45)

This output signal comes ON when the torque value calculated by the inverter decreases below the level specified by E80 (Detect low torque (Detection level)) for the time longer than the one specified by E81 (Detect low torque (Timer)). The minimum ON-duration is 100 ms.

 For details of the low output torque detection, refer to the description of function codes E80 and E81.

- Inverter in remote operation -- (RMT)
(Function code data = 54)

This output signal comes ON when the inverter switches from local to remote mode.

 For details about the remote and local modes, refer to Chapter 3, Section 3.3.3 "Switching between remote and local modes."

- Terminal [C1] wire break -- (C1OFF)
(Function code data = 59) *

This output signal comes ON when the inverter detects that the input current to terminal [C1] drops below 2 mA (after filtered by C38), interpreting it as a terminal [C1] wire break.

* Available for inverters having a ROM version 1400 or later.

 **Tip** The inverter's ROM version can be checked on Menu #5 "Maintenance Information" (5_ /4).

- Alarm output (for any alarm) -- (ALM)
(Function code data = 99)

This output signal comes ON if any of the protective functions is activated and the inverter enters Alarm mode.

E31	Frequency Detection (FDT) (Detection level)
E32*	Frequency Detection (FDT) (Hysteresis width)

When the output frequency exceeds the frequency detection level specified by E31, the **FDT** signal comes ON; when it drops below the "Frequency detection level (E31) - Hysteresis width (E32)," it goes OFF.

To utilize this feature, you need to assign **FDT** (data = 2) to any of digital output terminals.

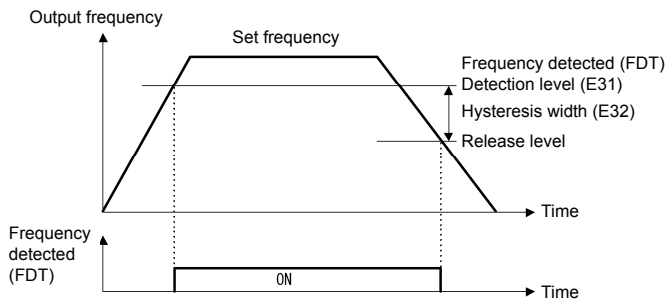

* Available for inverters having a ROM version 1400 or later.

Tip The inverter's ROM version can be checked on Menu #5 "Maintenance Information" (5-14).

E34	Overload Early Warning/Current Detection (Level)
E35	Overload Early Warning/Current Detection (Timer)

E34 and E35 specify, in conjunction with output terminal signals (OL) and (ID), the level and duration of overload and current beyond which an early warning will be issued.

■ Overload Early Warning

The warning signal (OL) is used to detect a symptom of an overload condition (alarm code \overline{OL} /) of the motor so that the user can take an appropriate action before the alarm actually happens. The signal turns on when the current level specified by E34 (Overload early warning) is exceeded. In typical cases, set E34 to 80-90% against data of F11 (Electronic thermal overload protection for motor (Overload detection level)). Specify also the thermal characteristics of the motor with F10 (Electronic thermal overload protection for motor (Select motor characteristics)) and F12 (Electronic thermal overload protection for motor (Thermal time constant)). To utilize this feature, you need to assign (OL) (Motor overload early warning) (data = 7) to any of the digital output terminals

■ Current Detection

The signal (ID) turns on when the output current of the inverter has exceeded the level specified by E34 (Current detection (Level)) and the output current continues longer than the period specified by E35 (Current detection (Timer)). The signal turns off when the output current drops below 90% of the rated operation level. (Minimum width of the output signal: 100 ms)

To utilize this feature, you need to assign (ID) (Current detection) (data = 37) to any of digital output terminals.

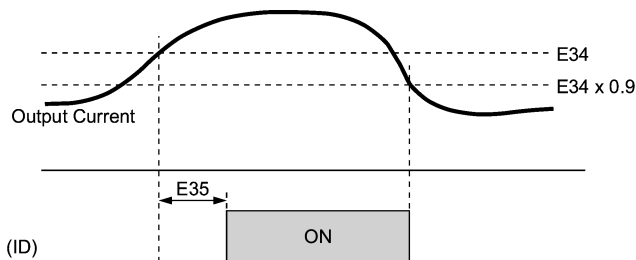

E51

Display Coefficient for Input Watt-hour Data

Use this coefficient (multiplication factor) for displaying the input watt-hour data ($S_{-} \text{ } \overline{17}$) in a part of maintenance information on the keypad.

The input watt-hour data will be displayed as follows:

E51 (Coefficient for input watt-hour data) \times Input watt-hour (kWh)

Note Setting E51 data to 0.000 clears the input watt-hour and its data to "0." After clearing, be sure to restore E51 data to the previous display coefficient; otherwise, input watt-hour data will not be accumulated.

 For the procedure for viewing maintenance information, refer to Chapter 3 "OPERATION USING THE KEYPAD."

E65

Command Loss Detection (Level)

When the analog frequency command (by frequency setting through terminals [12], [C1], and [V2]) has dropped below 10% of the expected frequency command within 400 ms, the inverter presumes that the analog frequency command wire has been broken and continues its operation at the frequency determined by the ratio specified by E65 to the reference frequency. When the frequency command level (in voltage or current) returns to a level higher than that specified by E65, the inverter presumes that the broken wire has been fixed and continues to run following the frequency command.

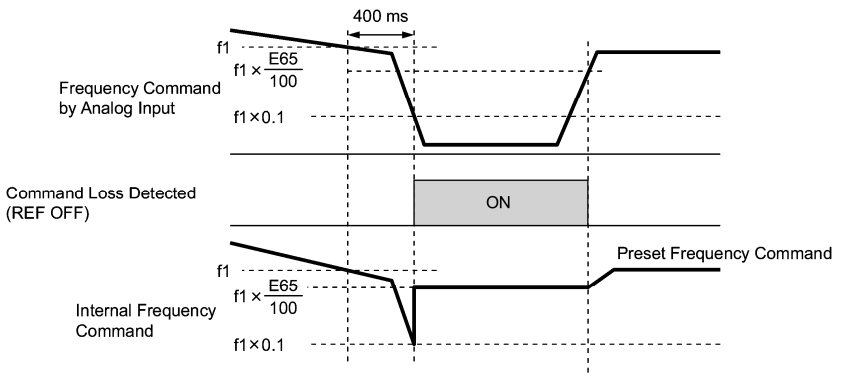

In the diagram above, f_1 is the level of the analog frequency command sampled at any given time. The sampling is repeated at regular intervals to continually monitor the wiring connection of the analog frequency command.

Note Avoid abrupt voltage or current change for the analog frequency command. Otherwise, a broken wire condition may be recognized.

When E65 is set at 999 (Disabled), though the command loss detection signal (REF OFF) is issued, the reference frequency remains unchanged (the inverter runs at the analog frequency command as specified).

When E65 is set at "0" or 999, the reference frequency level that the broken wire has been recognized as fixed is " $f_1 \times 0.2$."

When E65 is set at 100% or higher, the reference frequency level of the broken wire fixing is " $f_1 \times 1$."

The command loss detection is not affected by the setting of Analog input adjustment (filter time constants: C33, C38, and C43).

E80 Detect Low Torque (Detection level)
 E81 Detect Low Torque (Timer)

The signal (U-TL) turns on when the torque calculated by the inverter with reference to its output current has dropped below the level specified by E80 for the time longer than the one specified by E81. The signal turns off when the calculated torque exceeds the level specified by E80 + 5%. The minimum width of output signal is 100 ms.

You need to assign the "Low output torque detected" signal (U-TL) (data = 45) to the general-purpose output terminals.

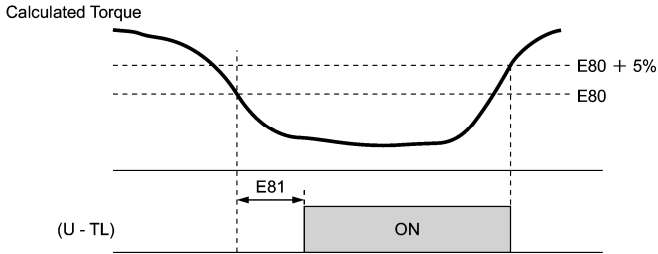

The detection level is set so that 100% corresponds to the rated torque of the motor.

In the inverter's low frequency operation, as a substantial error in torque calculation occurs, no low torque can be detected within the operation range at less than 20% of the base frequency (F04). (In this case, the result of recognition before entering this operation range is retained.)

The (U-TL) signal goes off when the inverter is stopped.

Since the motor parameters are used in the calculation of torque, it is recommended that auto-tuning be applied by function code P04 to achieve higher accuracy.

C33 Analog Input Adjustment for [12] (Filter time constant)
 C38 Analog Input Adjustment for [C1] (Filter time constant)
 C43 Analog Input Adjustment for [V2] (Filter time constant)

These function codes provide the filter time constants for the voltage and current of the analog input at terminals [12], [C1], and [V2]. Choose appropriate values for the time constants considering the response speed of the mechanical system as large time constants slow down the response. In case the input voltage fluctuates because of noise, specify large time constants.

P01 Motor (No. of poles)



P01 specifies the number of poles of the motor. Enter the value shown on the nameplate of the motor. This setting is used to display the motor speed on the LED monitor (refer to function code E43). The following formula is used for the conversion.

$$\text{Motor speed (r/min)} = \frac{120}{\text{No. of poles}} \times \text{Frequency (Hz)}$$

P02 Motor (Rated capacity)

P02 specifies the rated capacity of the motor. Enter the rated value shown on the nameplate of the motor.

Data for P02	Unit	Dependency on function code P99
0.01 to 1000	kW	P99 = 0, 3 or 4
	HP	P99 = 1

P03	Motor (Rated current)
<p>P03 specifies the rated current of the motor. Enter the rated value shown on the nameplate of the motor</p>	
P04	Motor (Auto-tuning)
<p>This function automatically detects the motor parameters and saves them in the inverter's internal memory. Basically, you do not need to perform tuning if you use a Fuji standard motor with a standard connection with the inverter.</p> <p>In any of the following cases, you may not obtain the best performance under auto torque boost, torque calculation monitoring, or auto energy saving operation, by default settings, since the motor parameters are different from that of Fuji standard motors. In such a case, perform auto tuning.</p> <ul style="list-style-type: none"> • The motor to be driven is made by other manufacturer or is a non-standard motor. • Cabling between the motor and the inverter is long. • A reactor is inserted between the motor and the inverter. <p> For details of auto tuning, refer to Chapter 4, Section 4.1.3 "Preparation before running the motor for a test -- Setting function code data."</p>	
P06 P07 P08	<p>Motor (No-load current) Motor (%R1) Motor (%X)</p>
<p>These function codes specify no load current, %R1, and %X. Obtain the appropriate values from the test report of the motor or by calling the manufacturer of the motor. If you perform auto tuning, these parameters are automatically set as well.</p> <ul style="list-style-type: none"> • No load current: Enter the value obtained from motor manufacturer. • %R1: Enter the value calculated by the following formula. $\%R1 = \frac{R1 + \text{Cable } R1}{V / (\sqrt{3} \times I)} \times 100 (\%)$ <p>where,</p> <p>R1: Primary resistance of the motor (Ω) Cable R1: Resistance of the output cable (Ω) V: Rated voltage of the motor (V) I: Rated current of the motor (A)</p> <ul style="list-style-type: none"> • %X: Enter the value calculated by the following formula: $\%X = \frac{X1 + X2 \times XM / (X2 + XM) + \text{Cable } X}{V / (\sqrt{3} \times I)} \times 100 (\%)$ <p>where,</p> <p>X1: Primary leakage reactance of the motor (Ω) X2: Secondary leakage reactance of the motor (converted to primary) (Ω) XM: Exciting reactance of the motor (Ω) Cable X: Reactance of the output cable (Ω) V: Rated voltage of the motor (V) I: Rated current of the motor (A)</p> <p> For reactance, choose the value at the base frequency (F04).</p>	

Automatic control (such as auto-torque boost and auto-energy saving) or electronic thermal motor overload protection uses the motor parameters and characteristics. To match the property of a control system with that of the motor, select characteristics of the motor and set H03 (Data Initialization) to "2" to initialize the old motor parameters stored in the inverter. When initialization is complete, data of P03, P06, P07, and P08 and the old related internal data are automatically updated.

For P99, enter the following data according to the motor type.

- P99 = 0: Fuji standard 8-series motors (Current standard)
- P99 = 3: Fuji standard 6-series motors (Conventional standard)
- P99 = 4 Other manufacturer's or unknown motors



If P99 = 4 (Other motors), the inverter runs following the motor characteristics of Fuji standard 8-series.

H03 initializes the current function code settings to the factory defaults or initializes the motor parameters.

To change the H03 data, it is necessary to press  and  keys or  and  keys simultaneously.

Data for H03	Function
0	Disable initialization (Settings manually made by the user will be retained.)
1	Initialize all function code data to the factory defaults
2	Initialize motor parameters in accordance with P02 (rated capacity) and P99 (motor selection) Function codes subject to initialization: P01, P03, P06, P07, and P08, including the internal control constants (These function codes will be initialized to the values listed in tables on the following pages.)

- To initialize the motor parameters, set the related function codes as follows.
 - 1) P02 Motor (Rated capacity) Set the rated capacity of the motor to be used in kW.
 - 2) P99 Motor Selection Select the characteristics of the motor. (Refer to the descriptions given for P99.)
 - 3) H03 Data Initializing Initialize the motor parameters. (H03=2)
 - 4) P03 Motor (Rated current) Set the rated current on the nameplate if the already set data differs from the rated current printed on the nameplate of the motor.
- Upon completion of the initialization, the data of function code H03 is reset to "0" (default setting).
- If a capacity other than that of applicable motor rating is set at P02, the capacity will be internally converted to the applicable motor rating (see the table on the following pages).

- When Fuji standard 8-series motors (P99 = 0) or other motors (P99 = 4) are selected, the motor parameters for P02 through P08 are as listed in following tables.

200 V series motors shipped for Taiwan and Korea (K)

Motor capacity (kW)	Applicable motor rating (kW)	Rated current (A)	No-load current (A)	%R (%)	%X (%)
P02		P03	P06	P07	P08
0.01 to 0.09	0.06	0.44	0.40	13.79	11.75
0.10 to 0.19	0.1	0.68	0.55	12.96	12.67
0.20 to 0.39	0.2	1.30	1.06	12.95	12.92
0.40 to 0.74	0.4	2.30	1.66	10.20	13.66
0.75 to 1.49	0.75	3.60	2.30	8.67	10.76
1.50 to 2.19	1.5	6.10	3.01	6.55	11.21
2.20 to 3.69	2.2	9.20	4.85	6.48	10.97
3.70 to 5.49	3.7	15.0	7.67	5.79	11.25
5.50 to 7.49	5.5	22.5	11.0	5.28	14.31
7.50 to 10.99	7.5	29.0	12.5	4.50	14.68
11.00 to 14.99	11	42.0	17.7	3.78	15.09
15.00 to 18.49	15	55.0	20.0	3.25	16.37
18.50 to 21.99	18.5	67.0	21.4	2.92	16.58
22.00 to 29.99	22	78.0	25.1	2.70	16.00
30.00 to 36.99	30	107	38.9	2.64	14.96
37.00 to 44.99	37	130	41.5	2.76	16.41
45.00 to 54.99	45	156	47.5	2.53	16.16
55.00 to 74.99	55	190	58.6	2.35	16.20
75.00 to 89.99	75	260	83.2	1.98	16.89
90.00 to 109.99	90	310	99.2	1.73	16.03
110.00 or above	110	376	91.2	1.99	20.86

400 V series motors shipped for Taiwan and Korea (K), and EU (E)

Motor capacity (kW)	Applicable motor rating (kW)	Rated current (A)	No-load current (A)	%R (%)	%X (%)
P02		P03	P06	P07	P08
0.01 to 0.09	0.06	0.22	0.20	13.79	11.75
0.10 to 0.19	0.10	0.35	0.27	12.96	12.67
0.20 to 0.39	0.20	0.65	0.53	12.95	12.92
0.40 to 0.74	0.4	1.15	0.83	10.20	13.66
0.75 to 1.49	0.75	1.80	1.15	8.67	10.76
1.50 to 2.19	1.5	3.10	1.51	6.55	11.21
2.20 to 3.69	2.2	4.60	2.43	6.48	10.97
3.70 to 5.49	3.7	7.50	3.84	5.79	11.25
5.50 to 7.49	5.5	11.5	5.50	5.28	14.31
7.50 to 10.99	7.5	14.5	6.25	4.50	14.68
11.00 to 14.99	11	21.0	8.85	3.78	15.09
15.00 to 18.49	15	27.5	10.0	3.25	16.37
18.50 to 21.99	18.5	34.0	10.7	2.92	16.58
22.00 to 29.99	22	39.0	12.6	2.70	16.00
30.00 to 36.99	30	54.0	19.5	2.64	14.96
37.00 to 44.99	37	65.0	20.8	2.76	16.41
45.00 to 54.99	45	78.0	23.8	2.53	16.16
55.00 to 74.99	55	95.0	29.3	2.35	16.20
75.00 to 89.99	75	130	41.6	1.98	16.89
90.00 to 109.99	90	155	49.6	1.73	16.03
110.00 to 131.99	110	188	45.6	1.99	20.86
132.00 to 159.99	132	224	57.6	1.75	18.90
160.00 to 199.99	160	272	64.5	1.68	19.73
200.00 to 219.99	200	335	71.5	1.57	20.02
220.00 to 249.99	220	365	71.8	1.60	20.90
250.00 to 279.99	250	415	87.9	1.39	18.88
280.00 to 314.99	280	462	93.7	1.36	19.18
315.00 to 354.99	315	520	120	0.84	16.68
355.00 to 399.99	355	580	132	0.83	16.40
400.00 to 449.99	400	670	200	0.62	15.67
450.00 to 529.99	450	770	270	0.48	13.03
530.00 or above	530	880	270	0.53	13.05

200 V series motors shipped for Asia (A)

Motor capacity (kW)	Applicable motor rating (kW)	Rated current (A)	No-load current (A)	%R (%)	%X (%)
P02		P03	P06	P07	P08
0.01 to 0.09	0.06	0.40	0.37	11.40	9.71
0.10 to 0.19	0.1	0.62	0.50	10.74	10.50
0.20 to 0.39	0.2	1.18	0.97	10.69	10.66
0.40 to 0.74	0.4	2.10	1.52	8.47	11.34
0.75 to 1.49	0.75	3.29	2.11	7.20	8.94
1.50 to 2.19	1.5	5.56	2.76	5.43	9.29
2.20 to 3.69	2.2	8.39	4.45	5.37	9.09
3.70 to 5.49	3.7	13.67	7.03	4.80	9.32
5.50 to 7.49	5.5	20.50	10.08	4.37	11.85
7.50 to 10.99	7.5	26.41	11.46	3.73	12.15
11.00 to 14.99	11	38.24	16.23	3.13	12.49
15.00 to 18.49	15	50.05	18.33	2.69	13.54
18.50 to 21.99	18.5	60.96	19.62	2.42	13.71
22.00 to 29.99	22	70.97	23.01	2.23	13.24
30.00 to 36.99	30	97.38	35.66	2.18	12.38
37.00 to 44.99	37	118.2	38.04	2.28	13.56
45.00 to 54.99	45	141.9	43.54	2.09	13.36
55.00 to 74.99	55	172.8	53.72	1.94	13.39
75.00 to 89.99	75	236.5	76.27	1.64	13.97
90.00 to 109.99	90	282.0	90.93	1.43	13.26
110.00 or above	110	342.0	83.60	1.65	17.25

400 V series motors shipped for Asia (A)

Motor capacity (kW)	Applicable motor rating (kW)	Rated current (A)	No-load current (A)	%R (%)	%X (%)
P02		P03	P06	P07	P08
0.01 to 0.09	0.06	0.19	0.16	12.54	10.68
0.10 to 0.19	0.1	0.31	0.21	12.08	11.81
0.20 to 0.39	0.2	0.58	0.42	12.16	12.14
0.40 to 0.74	0.4	1.07	0.66	9.99	13.38
0.75 to 1.49	0.75	1.72	0.91	8.72	10.82
1.50 to 2.19	1.5	3.10	1.20	6.89	11.80
2.20 to 3.69	2.2	4.54	1.92	6.73	11.40
3.70 to 5.49	3.7	7.43	3.04	6.04	11.73
5.50 to 7.49	5.5	11.49	4.35	5.55	15.05
7.50 to 10.99	7.5	14.63	4.95	4.78	15.59
11.00 to 14.99	11	21.23	7.01	4.02	16.06
15.00 to 18.49	15	28.11	7.92	3.50	17.61
18.50 to 21.99	18.5	35.01	8.47	3.16	17.97
22.00 to 29.99	22	40.11	9.98	2.92	17.32
30.00 to 36.99	30	55.21	15.44	2.84	16.10
37.00 to 44.99	37	66.88	16.47	2.99	17.77
45.00 to 54.99	45	80.43	18.84	2.75	17.54
55.00 to 74.99	55	97.91	23.20	2.55	17.58
75.00 to 89.99	75	133.8	32.93	2.15	18.30
90.00 to 109.99	90	159.4	39.27	1.87	17.35
110.00 to 131.99	110	195.3	36.10	2.18	22.81
132.00 to 159.99	132	232.4	45.60	1.91	20.64
160.00 to 199.99	160	282.7	51.06	1.84	21.58
200.00 to 219.99	200	349.1	56.60	1.72	21.96
220.00 to 249.99	220	381.0	56.84	1.76	22.96
250.00 to 279.99	250	432.5	69.59	1.52	20.71
280.00 to 314.99	280	481.9	74.18	1.49	21.06
315.00 to 354.99	315	541.0	95.00	0.92	18.27
355.00 to 399.99	355	603.6	104.5	0.91	17.96
400.00 to 449.99	400	691.5	158.3	0.67	17.02
450.00 to 529.99	450	788.5	213.7	0.52	14.05
530.00 or above	530	907.2	213.7	0.58	14.16

H04	Auto-resetting (Times)
H05	Auto-resetting (Reset interval)

While the auto-resetting feature is specified, even if the protective function subject to retry is activated and the inverter enters the forced-to-stop state (tripped state), the inverter will automatically attempt to reset the tripped state and restart without issuing an alarm (for any faults). If the protection function works in excess of the times specified by H04, the inverter will issue an alarm (for any faults) and not attempt to auto-reset the tripped state.

Listed below are the recoverable alarm statuses to be retried.

Alarm status	LED monitor displays:	Alarm status	LED monitor displays:
Instantaneous overcurrent protection	<i>OC 1, OC2 or OC3</i>	Motor overheated	<i>OH4</i>
Overvoltage protection	<i>OU 1, OU2 or OU3</i>	Motor overloaded	<i>OL 1</i>
Heat sink overheated	<i>OH 1</i>	Inverter overloaded	<i>OU</i>
Inverter overheated	<i>OH3</i>		

■ Number of resetting times (H04)

H04 specifies the number of auto-resetting "retry" times for automatically escaping the tripped state. If the protective function is activated more than the specified resetting (retry) times, the inverter issues an alarm (for any faults) and does not attempt to escape the tripped state.

⚠ WARNING
<p>If the "retry" function has been specified, the inverter may automatically restart and run the motor stopped due to a trip fault, depending on the cause of the tripping.</p> <p>Design the machinery so that human body and peripheral equipment safety is ensured even when the auto-resetting succeeds.</p> <p>Otherwise an accident could occur.</p>

■ Reset interval (H05)

H05 specifies the interval time to attempt performing auto-resetting the tripped state. Refer to the timing scheme diagram below.

<Operation timing scheme>

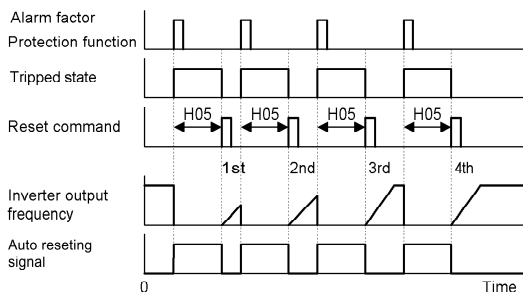

H06

Cooling Fan ON/OFF Control

To prolong the life of the cooling fan and to reduce fan noise during running, the cooling fan is stopped when the temperature inside the inverter drops below a certain level while the inverter is stopped. However, since frequent switching of the cooling fan shortens its life, it is kept running for 10 minutes once it is started.

This function code (H06: Cooling fan ON/OFF control) allows you to specify whether the cooling fan is to be kept running all the time or to be controlled ON/OFF.

Data for H06	Cooling fan ON/OFF
0	Disable (Always in operation)
1	Enable (ON/OFF controllable)

H07

Acceleration/Deceleration Pattern

H07 specifies the acceleration and deceleration patterns (Patterns to control output frequency).

Linear acceleration/deceleration

The inverter runs the motor with the constant acceleration and deceleration.

S-curve acceleration/deceleration

To reduce the impact on the inverter-driven motor and/or its mechanical load during acceleration/deceleration, the inverter gradually accelerates/decelerates the motor in both the acceleration/deceleration starting and ending zones. Two types of S-curve acceleration/deceleration are available; 5% (weak) and 10% (strong) of the maximum frequency, which are shared by the four inflection points. The acceleration/deceleration time command determines the duration of acceleration/deceleration in the linear period; hence, the actual acceleration/deceleration time is longer than the reference acceleration/deceleration time.

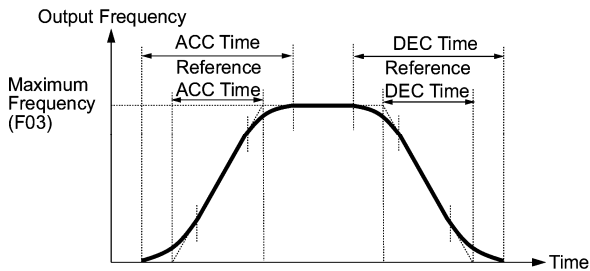

Acceleration/deceleration time

<S-curve acceleration/deceleration (weak): when the frequency change is more than 10% of the maximum frequency>

Acceleration/deceleration time (s): $(2 \times 5/100 + 90/100 + 2 \times 5/100) \times (\text{reference acceleration or deceleration time})$
 $= 1.1 \times (\text{reference acceleration or deceleration time})$

<S-curve acceleration/deceleration (strong): when the frequency change is more than 20% of the maximum frequency>

Acceleration/deceleration time (s): $(2 \times 10/100 + 80/100 + 2 \times 10/100) \times (\text{reference acceleration/deceleration time})$
 $= 1.2 \times (\text{reference acceleration/deceleration time})$

Curvilinear acceleration/deceleration

Acceleration/deceleration is linear below the base frequency (linear torque) but slows down above the base frequency to maintain a certain level of load factor (constant output).

This acceleration/deceleration pattern allows the motor to accelerate or decelerate with the maximum performance of the motor.

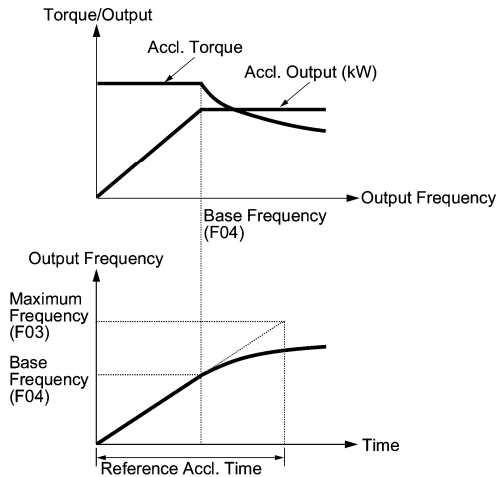

The figures at left show the acceleration characteristics. Similar characteristics apply to the deceleration.

Note Choose an appropriate acceleration/deceleration time considering the machinery's load torque.

H09
H17

Select Starting Characteristics (Auto search for idling motor speed)
Select Starting Characteristics (Frequency for idling motor speed)

H09 and H17 specify the auto search mode for idling motor speed and its frequency, respectively, to run the idling motor without stopping it.

The auto search mode can be switched by assigning the (STM) terminal command to one of digital input terminals (E01 to E05, function code data = 26). If no (STM) is assigned, the inverter interprets it as (STM) being ON by default.

Searching for idling motor speed

When a run command is turned ON with the (STM) being ON, the inverter starts the auto search operation at the auto search frequency specified by H17 to run the idling motor without stopping it. If there is a large difference between the motor speed and the auto search frequency, the current limiting control may be triggered. The inverter automatically reduces its output frequency to harmonize the idling motor speed. Upon completion of the harmonization, the inverter releases the current limiting control and accelerates the motor up to the reference frequency according to the preset acceleration time.

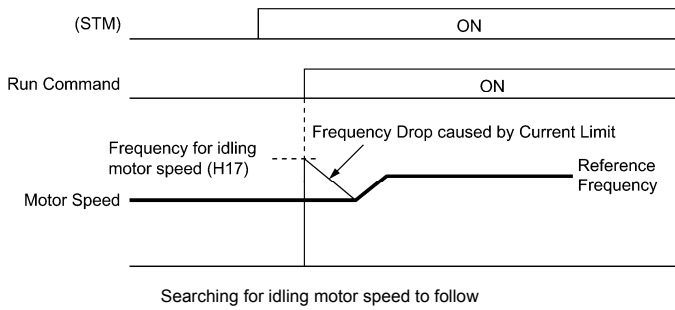

Note The frequency drop caused by the current limiting control during auto search for idling motor speed is determined by the frequency fall rate specified by H14.

To use the auto search, be sure to enable the instantaneous overcurrent limiting (H12 = 1).

■ Select starting characteristic (STM) (Digital input signal)

The (STM) terminal command specifies whether or not to perform auto search operation for idling motor speed at the start of running.

Data for H09	Auto search for idling motor speed	"Select starting characteristics" terminal command (STM)	Function
0	Disable	-	Start at the starting frequency
3, 4, 5	Enable	ON	Start at the auto search frequency specified by H17
		OFF	Start at the starting frequency

■ Frequency for idling motor speed (H17)

H17 specifies the auto search frequency for idling motor speed. Be sure to set a value higher than the idling motor speed. Otherwise, an overvoltage trip may occur. If the current motor speed is unknown, specify "999" that uses the maximum frequency at the start of auto search operation.

■ Auto search for idling motor speed (H09)

H09 specifies the starting rotational direction (forward/reverse) of the auto search and the starting pattern (patterns 1 to 4). If the motor is idling in the reverse direction that is against the specified direction because of natural convection, it is necessary to start it in the direction opposite to the rotational direction of the original reference frequency.

When the rotational direction of the idling motor is unknown, two starting patterns are provided as listed below, which start search from the forward rotation and, if not succeeded from the reverse rotation (e.g. H09 =5, pattern 3), start search from the reverse rotation (e.g. H09 =5, pattern 4).

Data for H09	Run command	Rotational direction at the start of auto search	Starting pattern
3	Run forward	Forward	Pattern 1
	Run reverse	Reverse	Pattern 2
4	Run forward	Forward	Pattern 3
	Run reverse	Reverse	Pattern 4
5	Run forward	Reverse	Pattern 4
	Run reverse	Forward	Pattern 3

Starting patterns

The inverter makes its frequency shift in accordance with the starting patterns shown below to search the speed and rotation direction of the idling motor. When harmonization is complete between the motor speed (including its rotation direction) and the inverter output frequency, the frequency shift by auto search operation is terminated.

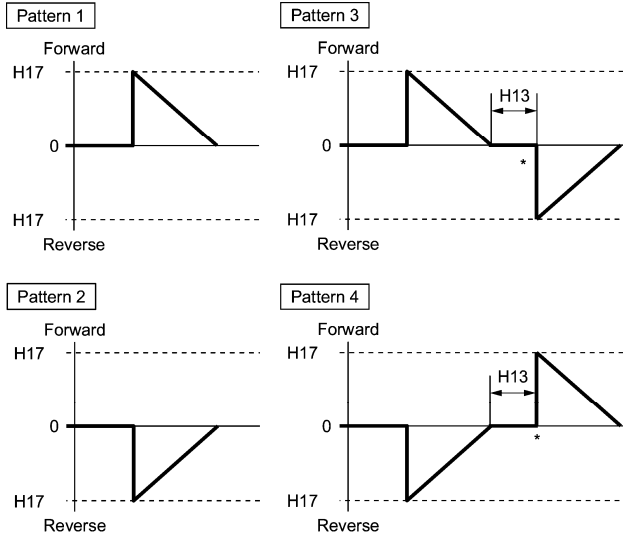

* Only when the auto search has not succeeded at the first trial, the starting from the opposite direction is attempted.

Starting Patterns

Note Auto search operation is attempted using one of the patterns shown above. If not succeeded, it will be tried again. If seven consecutive retries failed, the inverter will issue **OC3** alarm and stop.

H11

Deceleration Mode

H11 specifies the mode of deceleration when a run command is turned OFF.

Data for H11	Function
0	Normal deceleration The inverter decelerates and stops the motor according to deceleration commands specified by H07 (Acceleration/deceleration pattern) and F08 (Deceleration time 1).
1	Coast-to-stop The inverter immediately shuts down its output. The motor stops according to the inertia of motor and load machinery and their kinetic energy losses.

Note When the reference frequency is low, the inverter decelerates the motor according to the deceleration commands even if H11 = 1 (Coast-to-stop).

H12 specifies whether the inverter invokes the current limit processing or enters the overcurrent trip when its output current exceeds the instantaneous overcurrent limiting level. Under the current limit processing, the inverter immediately turns off its output gate to suppress the further current increase and continues to control the output frequency.

Data for H12	Function
0	Disable An overcurrent trip occurs at the instantaneous overcurrent limiting level.
1	Enable The current limiting operation is effective.

If any problem occurs when the motor torque temporarily drops during current limiting processing, it is necessary to cause an overcurrent trip (H12 = 0) and actuate a mechanical brake at the same time.

Note Function codes F43 and F44 have current limit functions similar to that of function code H12. Since the current limit functions of F43 and F44 implement the current control by software, an operation delay occurs. When you have enabled the current limit by F43 and F44, enable the current limit operation by H12 as well, to obtain a quick response current limiting.

Depending on the load, extremely short acceleration time may activate the current limiting to suppress the increase of the inverter output frequency, causing the system oscillation (hunting) or activating the inverter overvoltage trip (\overline{U} alarm). When setting the acceleration time, therefore, you need to take into account machinery characteristics and moment of inertia of the load.

H30
y98

Communications Link Function (Mode selection)
Bus Link Function (Function selection)

H30 and y98 specify the sources of a frequency command and run command—"inverter itself" and "computers or PLCs via the RS485 communications link (standard or option) or field bus (option)." H30 is for the RS485 communications link, and y98 for the field bus.

Using the communications link function allows you to monitor the operation information of the inverter and the function code data, set frequency commands, and issue run commands from a remote location.

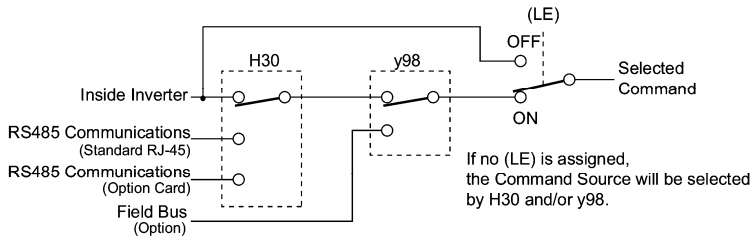

Command sources selectable

Command sources	Description
Inverter itself	Sources except RS485 communications link and field bus Frequency command source: Specified by F01 and C30, or multistep frequency command Run command source: Via the keypad or digital input terminals
Via RS485 communications link (standard)	Via the standard RJ-45 port used for connecting keypad
Via RS485 communications link (option card)	Via RS485 communications link (option card)
Via field bus (option)	Via field bus (option) using FA protocol such as DeviceNet or PROFIBUS-DP

Command sources specified by H30

Data for H30	Frequency command	Run command
0	Inverter itself (F01/C30)	Inverter itself (F02)
1	Via RS485 communications link (standard)	Inverter itself (F02)
2	Inverter itself (F01/C30)	Via RS485 communications link (standard)
3	Via RS485 communications link (standard)	Via RS485 communications link (standard)
4	Via RS485 communications link (option card)	Inverter itself (F02)
5	Via RS485 communications link (option card)	Via RS485 communications link (standard)
6	Inverter itself (F01/C30)	Via RS485 communications link (option card)
7	Via RS485 communications link (standard)	Via RS485 communications link (option card)
8	Via RS485 communications link (option card)	Via RS485 communications link (option card)

Command sources specified by y98

Data for y98	Frequency command	Run command
0	Follow H30 data	Follow H30 data
1	Via field bus (option)	Follow H30 data
2	Follow H30 data	Via field bus (option)
3	Via field bus (option)	Via field bus (option)

Combination of command source

		Frequency command			
		Inverter itself	Via RS485 communications link (standard)	Via RS485 communications link (option card)	Via field bus (option)
Run command	Inverter itself	H30 = 0 y98 = 0	H30 = 1 y98 = 0	H30=4 y98=0	H30=0 (1 or 4) y98=1
	Via RS485 communications link (standard)	H30 = 2 y98 = 0	H30 = 3 y98 = 0	H30=5 y98=0	H30=2 (3 or 5) y98=1
	Via RS485 communications link (option card)	H30 = 6 y98 = 0	H30 = 7 y98 = 0	H30=8 y98=0	H30=6 (7 or 8) y98=1
	Via field bus (option)	H30 = 0 (2 or 6) y98 = 2	H30 = 1 (3 or 7) y98 = 2	H30 = 4 (5 or 8) y98 = 2	H30 = 0 (1 to 8) y98 = 3

 For details, refer to the FRENIC-Eco User's Manual (MEH456), Chapter 4 "BLOCK DIAGRAMS FOR CONTROL LOGIC" and the RS485 communication User's Manual (MEH448a) or the Field Bus Option Instruction Manual.

- When the (LE) terminal command is assigned to a digital input terminal and the terminal is ON, the settings of function code H30 and y98 are effective. When the terminal is OFF, the settings of those function codes are ineffective, and both frequency commands and run commands specified from the inverter itself take control.

H69**Automatic Deceleration**

H69 specifies whether automatic deceleration control is to be enabled or disabled. During deceleration of the motor, if regenerative energy exceeds the level that can be handled by the inverter, overvoltage trip may happen. With automatic deceleration enabled, when the DC link bus voltage exceeds the level (internally fixed) for starting automatic deceleration, the output frequency is controlled to prevent the DC link bus voltage from rising further; thus regenerative energy is suppressed.



Note If automatic deceleration is enabled, deceleration may take a longer time. This is designed to limit the torque during deceleration, and is therefore of no use where there is a braking load.

Disable the automatic deceleration when a braking unit is connected. The automatic deceleration control may be activated at the same time when a braking unit starts operation, which may make the acceleration time fluctuate. In case the set deceleration time is so short, the DC link bus voltage of the inverter rises quickly, and consequently, the automatic deceleration may not follow the voltage rise. In such a case, prolong the deceleration time.

Even if the time period of 3 times of the deceleration time 1 (F08) has elapsed after the inverter entered automatic deceleration, there may be a case that the motor does not stop or the frequency does not decrease. In this case, cancel the automatic deceleration forcibly for safety and decelerate the motor according to the set deceleration time. Prolong the deceleration time also.

H70**Overload Prevention Control**

H70 specifies the rate of decreasing the output frequency to prevent an overload condition. Under this control, an overload trip is prevented by decreasing the output frequency of the inverter before the inverter trips because of the overheating of the cooling fan or the overloading of the inverter (with an alarm indication of $\overline{O.H.}$ or $\overline{O.L.L.}$). This control is useful for facilities such as pumps where a decrease in the output frequency leads to a decrease in the load and it is necessary to keep the motor running even when the output frequency goes low.

Data for H70	Function
0.00	Decelerate the motor by deceleration time 1 specified by F08
0.01 to 100.0	Decelerate the motor by deceleration rate 0.01 to 100.0 (Hz/s)
999	Disable overload prevention control



Note In applications where a decrease in the output frequency does not lead to a decrease in the load, this function is of no use and should not be enabled.

H91**PID Feedback Wire Break Detection ***

If all of the following conditions are satisfied during the period (0.1 to 60.0 s) specified by H91, an alarm $\overline{C.B.F.}$ will be issued. Setting H91 at 0.0 s disables wire break detection.

- The input current on the terminal [C1] is less than 2 mA.
- The terminal [C1] is used for the feedback input of PID control (E62=5).
- Under the PID control

* Available for inverters having a ROM version 1400 or later.



Tip The inverter's ROM version can be checked on Menu #5 "Maintenance Information" (5-14).



H94 Cumulative Run Time of Motor

You can view the cumulative run time of the motor on the keypad. This feature is useful for management and maintenance of the mechanical system. With this function code (H94), you can set the cumulative run time of the motor to any value you choose. For example, by specifying "0," you can clear the cumulative run time of the motor.

 **Note** The data for H94 is in hexadecimal notation. Check the cumulative run time of the motor on the keypad.

H97 Clear Alarm Data

H97 deletes the information such as alarm history and data at the time of alarm occurrence, including alarms that have occurred during the check-up or adjustment of the machinery. Data is then brought back to a normal state without an alarm.

Deleting the alarm information requires simultaneous keying of  and  keys.

Data for H97	Function
0	Disable
1	Clear all (This data clears all alarm data stored and returns to "0.")

H98 Protection/Maintenance Function

H98 specifies whether to enable or disable (a) automatic lowering of the carrier frequency, (b) protection against input phase loss, (c) protection against output phase loss, and (d) judgment on the DC link bus capacitor life, and the change of judgment criteria on the DC link bus capacitor life and the selection of handling on DC fan lock detection, in a style of combination.

Automatic lowering function of carrier frequency

You have to prevent important machinery from stopping as much as possible. Even if the inverter is in heat sink overheating or overload state because of excessive load, abnormal ambient temperature, or a trouble in the cooling system, with this function enabled, the inverter lowers the carrier frequency to avoid tripping (*OH1*, *OH3* or *OLL*). Note that if this feature is enabled the motor noise increases.

Protection against input phase loss (*L₁₇*)

Upon detecting an excessive stress inflicted on the apparatus connected to the main circuit because of phase loss or inter-phase imbalance in the 3-phase power supplied to the inverter, this feature stops the inverter and displays an alarm *L₁₇*.

 **Note** In configurations where only a light load is driven or a DC reactor is connected, a phase loss or an inter-phase imbalance may not be detected because of the relatively small stress on the apparatus connected to the main circuit.

Protection against output phase loss (*OP_L*: Output Phase Loss)

Upon detecting a phase loss in the output while the inverter is running, this feature stops the inverter and displays an alarm *OP_L*. Where a magnetic contactor is installed in the inverter output circuit, if the magnetic contactor goes OFF during operation, all the phases will be lost. In such a case, this protection feature does not work.

Selection of life judgment criteria of the DC link bus capacitors

Allows you to select the criteria for judging the life of the DC link bus capacitor/s (reservoir capacitor/s) between factory default setting and your own choice.



Before specifying the criteria of your own choice, measure and confirm the reference level in advance. For details, refer to Chapter 7 "MAINTENANCE AND INSPECTION."

Judgment on the life of DC link bus capacitors

Whether the DC link bus capacitor (reservoir capacitor) has reached its life is determined by measuring the length of time for discharging after power off. The discharging time is determined by the capacitance of the DC link bus capacitor and the load inside the inverter. Therefore, if the load inside the inverter fluctuates significantly, the discharging time cannot be accurately measured, and as a result, it may be mistakenly determined that the life has been reached. To avoid such an error, you can disable the judgment on the life of the DC link bus capacitor.

Load may vary significantly in the following cases. Disable the judgment on the life during operation, and either conduct the measurement with the judgment enabled under appropriate conditions during periodical maintenance or conduct the measurement under the actual use conditions.

- Auxiliary input for control power is used
- An option card or multi-function keypad is used
- Another inverter or equipment such as a PWM converter is connected to the terminals of the DC link bus.



For details, refer to Chapter 7 "MAINTENANCE AND INSPECTION."

Detection of DC fan lock (200 V series: 45 kW or above, 400 V series: 55 kW or above)

An inverter of 45 kW or above (200 V series), or of 55 kW or above (400 V series) is equipped with the internal air circulation DC fan. When the inverter detects that the DC fan is locked by a failure or other cause, you can select either continuing the inverter operation or entering into alarm state.

Entering alarm state: The inverter issues the alarm \square / and coasts to stop the motor.

Continuing operation: The inverter does not enter the alarm mode, and continues operation of the motor.

Note that, however, the inverter turns on (OH) and (LIFE) signals on the transistor output terminals whenever the DC fan lock is detected regardless your selection.



If ON/OFF control of the cooling fan is enabled (H06 = 1), the cooling fan may stop depending on operating condition of the inverter. In this case, the DC fan lock detection feature is considered normal (e.g.; the cooling fan is normally stopped by the stop fan command.) so that the inverter may turn off the (LIFE) or (OH) signal output, or enable to cancel the \square / alarm, even if the internal air circulation DC fan is locked due to a failure etc. (When you start the inverter in this state, it automatically issues the run fan command, then the inverter detects the DC fan lock state, and turn on the (LIFE) or (OH) output or enters the \square / alarm state.)

Note that, operating the inverter under the condition that the DC fan is locked for long time may shorten the life of electrolytic capacitors on the control PCB due to local high temperature inside the inverter. Be sure to check with the (LIFE) signal etc., and replace the broken fan as soon as possible.

To set data of the function code H98, assign functions to each bit (total 6 bits) and set it in decimal format. The table below lists functions assigned to each bit.

Bit	Bit 5	Bit 4	Bit 3	Bit 2	Bit 1	Bit 0
Function	Detect DC fan lock	Judge the life of DC link bus capacitor	Select life judgment criteria of DC link bus capacitor	Detect output phase loss	Detect input phase loss	Lower the carrier frequency automatically
Data = 0	Enter into the alarm state	Disable	Use the factory default	Disable	Disable	Disable
Data = 1	Continue the operation	Enable	Use the user setting	Enable	Enable	Enable
Example of decimal expression (19)	Enter into the alarm state (0)	Enable (1)	Use the factory default (0)	Disable (0)	Enable (1)	Enable (1)

Conversion table (Decimal to/from binary)

Decimal	Binary						Decimal	Binary					
	Bit 5	Bit 4	Bit 3	Bit 2	Bit 1	Bit 0		Bit 5	Bit 4	Bit 3	Bit 2	Bit 1	Bit 0
0	0	0	0	0	0	0	32	1	0	0	0	0	0
1	0	0	0	0	0	1	33	1	0	0	0	0	1
2	0	0	0	0	1	0	34	1	0	0	0	1	0
3	0	0	0	0	1	1	35	1	0	0	0	1	1
4	0	0	0	1	0	0	36	1	0	0	1	0	0
5	0	0	0	1	0	1	37	1	0	0	1	0	1
6	0	0	0	1	1	0	38	1	0	0	1	1	0
7	0	0	0	1	1	1	39	1	0	0	1	1	1
8	0	0	1	0	0	0	40	1	0	1	0	0	0
9	0	0	1	0	0	1	41	1	0	1	0	0	1
10	0	0	1	0	1	0	42	1	0	1	0	1	0
11	0	0	1	0	1	1	43	1	0	1	0	1	1
12	0	0	1	1	0	0	44	1	0	1	1	0	0
13	0	0	1	1	0	1	45	1	0	1	1	0	1
14	0	0	1	1	1	0	46	1	0	1	1	1	0
15	0	0	1	1	1	1	47	1	0	1	1	1	1
16	0	1	0	0	0	0	48	1	1	0	0	0	0
17	0	1	0	0	0	1	49	1	1	0	0	0	1
18	0	1	0	0	1	0	50	1	1	0	0	1	0
19	0	1	0	0	1	1	51	1	1	0	0	1	1
20	0	1	0	1	0	0	52	1	1	0	1	0	0
21	0	1	0	1	0	1	53	1	1	0	1	0	1
22	0	1	0	1	1	0	54	1	1	0	1	1	0
23	0	1	0	1	1	1	55	1	1	0	1	1	1
24	0	1	1	0	0	0	56	1	1	1	0	0	0
25	0	1	1	0	0	1	57	1	1	1	0	0	1
26	0	1	1	0	1	0	58	1	1	1	0	1	0
27	0	1	1	0	1	1	59	1	1	1	0	1	1
28	0	1	1	1	0	0	60	1	1	1	1	0	0
29	0	1	1	1	0	1	61	1	1	1	1	0	1
30	0	1	1	1	1	0	62	1	1	1	1	1	0
31	0	1	1	1	1	1	63	1	1	1	1	1	1

When the inverter is stopped, dew condensation on the motor can be prevented, by feeding DC power to the motor at regular intervals to keep the temperature of the motor above a certain level. To utilize this feature, you need to assign a terminal command (DWP) (dew condensation prevention) to one of general-purpose digital input terminals (function code data = 39).

■ Enabling Dew Condensation Prevention

To enable dew condensation prevention, turn ON the condensation prevention command (DWP) while the inverter is stopped. Then, this feature starts.

■ Dew Condensation Prevention (Duty) (J21)

The magnitude of the DC power applied to the motor is the same as the setting of F21 (DC Braking, Braking level) and its duration inside each interval is the same as the setting of F22 (DC Braking, Braking time). The interval T is determined so that the ratio of the duration of the DC power to T is the value (Duty) set for J21.

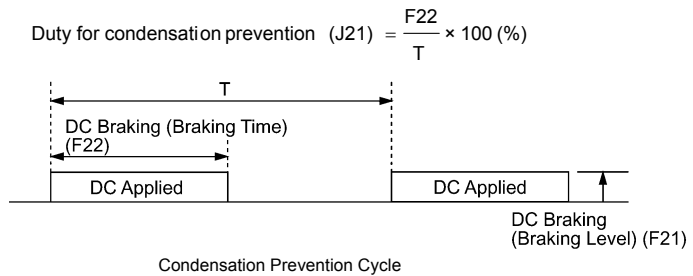

Chapter 6 TROUBLESHOOTING

6.1 Before Proceeding with Troubleshooting

⚠ WARNING ⚠

If any of the protective functions have been activated, first remove the cause. Then, after checking that the all run commands are set to off, reset the alarm. Note that if the alarm is reset while any run commands are set to on, the inverter may supply the power to the motor which may cause the motor to rotate.

Injury may occur.

- Even though the inverter has interrupted power to the motor, if the voltage is applied to the main circuit power input terminals L1/R, L2/S and L3/T, voltage may be output to inverter output terminals U, V, and W.
- Turn OFF the power and wait more than five minutes for models of 30 kW or below, or ten minutes for models of 37 kW or above. Make sure that the LED monitor and charging lamp (on models of 37 kW or above) are turned OFF. Further, make sure, using a multimeter or a similar instrument, that the DC link bus voltage between the terminals P (+) and N (-) has dropped below the safe voltage (+25 VDC).

Electric shock may occur.

Follow the procedure below to solve problems.

- (1) First, check that the inverter is correctly wired, referring to Chapter 2 Section 2.3.6 "Wiring for main circuit terminals and grounding terminals."
- (2) Check whether an alarm code is displayed on the LED monitor.

- No alarm code appears on the LED monitor

Abnormal motor operation

- [1] The motor does not rotate.
- [2] The motor rotates, but the speed does not increase.
- [3] The motor runs in the opposite direction to the command.
- [4] If the speed variation and current vibration (such as hunting) occur at the constant speed
- [5] If grating sound can be heard
- [6] The motor does not accelerate and decelerate at the set time.
- [7] Even if the power recovers after an instantaneous power failure, the motor does not restart.

→ Go to Section 6.2.1

Problems with inverter settings

- [1] Nothing appears on the LED monitor.
- [2] The desired menu is not displayed.
- [3] Data of function codes cannot be changed

→ Go to Section 6.2.2

- If an alarm code appears on the LED monitor

→ Go to Section 6.3

- If an abnormal pattern appears on the LED monitor while no alarm code is displayed

→ Go to Section 6.4

If any problems persist after the above recovery procedure, contact your Fuji Electric representative.

6.2 If No Alarm Code Appears on the LED Monitor

6.2.1 Motor is running abnormally

[1] The motor does not rotate.

Possible Causes	What to Check and Suggested Measures
(1) No power supplied to the inverter.	<p>Check the input voltage, output voltage and interphase voltage unbalance.</p> <ul style="list-style-type: none"> → Turn ON a molded case circuit breaker, an earth leakage circuit breaker (with overcurrent protection) or a magnetic contactor. → Check for voltage drop, phase loss, poor connections, or poor contacts, and fix them if necessary. → If only auxiliary control power is supplied, turn ON the main power.
(2) No forward/reverse operation command was inputted, or both the commands were inputted simultaneously (external signal operation).	<p>Check the input status of the forward/reverse command with Menu #4 "I/O Checking" using the keypad.</p> <ul style="list-style-type: none"> → Input a run command. → Set either the forward or reverse operation command to off if both commands are being inputted. → Correct the assignment of commands (FWD) and (REV) to function codes E98 and E99. → Connect the external circuit wires to control circuit terminals [FWD] and [REV] correctly. → Make sure that the sink/source slide switch on the printed circuit board is properly configured.
(3) No indication of rotation direction (keypad operation).	<p>Check the input status of the forward/reverse rotation direction command with Menu #4 "I/O Checking" using the keypad.</p> <ul style="list-style-type: none"> → Input the rotation direction (F02=0), or select the keypad operation with which the rotation direction is fixed (F02=2 or 3).
(4) The inverter could not accept any run commands from the keypad since it was in Programming mode.	<p>Check which operation mode the inverter is in, using the keypad.</p> <ul style="list-style-type: none"> → Shift the operation mode to Running mode and enter a run command.
(5) A run command with higher priority than the one attempted was active, and the run command was stopped.	<p>While referring to the block diagram of the drive command generator*, check the higher priority run command with Menu #2 "Data Checking" and Menu #4 "I/O Checking" using the keypad.</p> <p>*Refer to the FRENIC-Eco User's Manual (MEH456), Chapter 4.</p> <ul style="list-style-type: none"> → Correct any incorrect function code data settings (in H30, y98, etc.) or cancel the higher priority run command.
(6) The frequency command was set below the starting or stop frequency.	<p>Check that a frequency command has been entered, with Menu #4 "I/O Checking" using the keypad.</p> <ul style="list-style-type: none"> → Set the value of the frequency command to the same or higher than that of the starting or stop frequency (F23 or F25). → Reconsider the starting and stop frequencies (F23 and F25), and if necessary, change them to lower values. → Inspect the frequency command, signal converters, switches, or relay contacts. Replace any ones that are faulty. → Connect the external circuit wires correctly to terminals [13], [12], [11], [C1], and [V2].
(7) A frequency command with higher priority than the one attempted was active.	<p>Check the higher priority run command with Menu #2 "Data Checking" and Menu #4 "I/O Checking" using the keypad, referring to the block diagram of the drive command generator*.</p> <p>*Refer to the FRENIC-Eco User's Manual (MEH456), Chapter 4.</p> <ul style="list-style-type: none"> → Correct any incorrect function code data settings (e.g. cancel the higher priority run command).
(8) The upper and lower frequencies for the frequency limiters were set incorrectly.	<p>Check the data of function codes F15 (Frequency limiter (high)) and F16 (Frequency limiter (low)).</p> <ul style="list-style-type: none"> → Change the settings of F15 and F16 to the correct ones.





Possible Causes	What to Check and Suggested Measures
(9) The coast-to-stop command was effective.	<p>Check the data of function codes E01, E02, E03, E04, E05, E98 and E99 and the input signal status with Menu #4 "I/O Checking" using the keypad.</p> <p>→ Release the coast-to-stop command setting.</p>
(10) Broken wire, incorrect connection or poor contact with the motor.	<p>Check the cabling and wiring (Measure the output current).</p> <p>→ Repair the wires to the motor, or replace them.</p>
(11) Overload	<p>Measure the output current.</p> <p>→ Lighten the load (In winter, the load tends to increase.)</p>
	<p>Check that a mechanical brake is in effect.</p> <p>→ Release the mechanical brake, if any.</p>
(12) Torque generated by the motor was insufficient.	<p>Check that the motor starts running if the value of torque boost (F09) is increased.</p> <p>→ Increase the value of torque boost (F09) and try to run the motor.</p>
	<p>Check the data of function codes F04, F05, H50, and H51.</p> <p>→ Change the V/f pattern to match the motor's characteristics.</p>
	<p>Check whether the frequency command signal is below the slip-compensated frequency of the motor.</p> <p>→ Change the frequency command signal so that it becomes higher than the slip-compensated frequency of the motor.</p>
(13) Miss-/weak-connection of the DC reactor (DCR)	<p>Check the wiring connection. A DC reactor is built-in for 75 kW or above models. FRENIC-Eco inverter cannot run without a DC reactor.</p> <p>→ Connect the DC reactor correctly. Repair or replace wires for the DC reactor.</p>

[2] The motor rotates, but the speed does not increase.

Possible Causes	What to Check and Suggested Measures
(1) The maximum frequency currently specified was too low.	<p>Check the data of function code F03 (Maximum frequency).</p> <p>→ Readjust the data of F03.</p>
(2) The data of frequency limiter currently specified was too low.	<p>Check the data of function code F15 (Frequency limiter (high)).</p> <p>→ Readjust the data of F15.</p>
(3) The reference frequency currently specified was too low.	<p>Check the signals for the frequency command from the control circuit terminals with Menu #4 "I/O Checking" on the keypad.</p> <p>→ Increase frequency of the command.</p> <p>→ If an external potentiometer for frequency command, signal converter, switches, or relay contacts are malfunctioning, replace them.</p> <p>→ Connect the external circuit wires to terminals [13], [12], [11], [C1], and [V2] correctly.</p>
(4) A frequency command (e.g., multistep frequency or via communications) with higher priority than the one expected was active and its reference frequency was too low.	<p>Check the data of the relevant function codes and what frequency commands are being received, through Menu #1 "Data Setting," Menu #2 "Data Checking" and Menu #4 "I/O Checking," on the keypad by referring to the block diagram of the frequency command".</p> <p>*Refer to the FRENIC-Eco User's Manual (MEH456), Chapter 4.</p> <p>→ Correct any incorrect data of function code (e.g. The higher priority run command is mistakenly canceled, etc.).</p>
(5) The acceleration time was too long.	<p>Check the data of function code F07 (Acceleration time 1)</p> <p>→ Change the acceleration/deceleration time to match the load.</p>

Possible Causes	What to Check and Suggested Measures
(6) Overload	Measure the output current. → Lighten the load.
	Check if mechanical brake is working. → Release the mechanical brake (Adjust the dumper of the fan or the valve of the pump). (In winter, the load tends to increase.)
(7) Mismatch with the characteristics of the motor	In case auto-torque boost or auto-energy saving operation is under way, check whether P02, P03, P06, P07, and P08 agree with the parameters of the motor. → Set P02, P03, and P06 properly and perform auto-tuning in accordance with P04.
(8) The current limiting operation did not increase the output frequency.	Make sure that F43 (Current limiter (mode selection)) is set to "2" and check the setting of F44 (Current limiter (level)). → If the current limiting operation is not needed, set F43 to "0" (disabled).
	Decrease the value of torque boost (F09), then turn the power OFF and back on again and check if the speed increases. → Adjust the value of the torque boost (F09).
	Check the data of function codes F04, F05, H50, and H51 to ensure that the V/f pattern is right. → Match the V/f pattern values with the motor ratings.
(9) Bias and gain set incorrectly.	Check the data of function codes F18, C50, C32, C34, C37, C39, C42, and C44. → Readjust the bias and gain to appropriate values.

[3] The motor runs in the opposite direction to the command.

Possible Causes	What to Check and Suggested Measures
(1) Wiring has been connected to the motor incorrectly.	Check the wiring to the motor. → Connect terminals U, V, and W of the inverter to the respective U, V, and W terminals of the motor.
(2) Incorrect connection and settings for run commands and rotation direction command (FWD) and (REV)	Check the data of function codes E98 and E99 and the connection to terminals [FWD] and [REV]. → Correct the data of the function codes and the connection.
(3) The setting for the rotation direction via keypad operation is incorrect.	Check the data of function code F02 (Run command). → Change the data of function code F02 to "2: Enable  /  keys on keypad (forward)" or "3: Enable  /  keys on keypad (reverse)."

[4] If the speed variation and current vibration (such as hunting) occur at the constant speed

Possible Causes	What to Check and Suggested Measures
(1) The frequency command fluctuated.	Check the signals for the frequency command with Menu #4 "I/O Checking" using the keypad. → Increase the filter constants (C33, C38, and C43) for the frequency command.

Possible Causes	What to Check and Suggested Measures
(2) The external frequency command source device was used.	<p>Check that there is no noise in the control signal wires from external sources.</p> <ul style="list-style-type: none"> → Isolate the control signal wires from the main circuit wires as far as possible. → Use shielded or twisted wires for the control signal.
	<p>Check whether the frequency command source has not failed because of noise from the inverter.</p> <ul style="list-style-type: none"> → Connect a capacitor to the output terminal of the frequency command source or insert a ferrite core in the signal wire. (Refer to Chapter 2 Section 2.3.7 "Wiring for control circuit terminals.")
(3) Frequency switching or multistep frequency command was enabled.	<p>Check whether the relay signal for switching the frequency command is chattering.</p> <ul style="list-style-type: none"> → If the relay has a contact problem, replace the relay.
(4) The connection between the inverter and the motor was too long.	<p>Check whether auto-torque boost or auto-energy saving operation is enabled.</p> <ul style="list-style-type: none"> → Set P02, P03, and P06 properly and perform auto-tuning in accordance with P04. → Enable load selection for higher startup torque (F37 = 1) and check for any vibration. → Make the output wire as short as possible.
(5) The inverter output is hunting due to vibration caused by low stiffness of the load. Or the current is irregularly oscillating due to special motor parameters.	<p>Cancel the automatic control system--automatic torque boost and energy saving operation (F37), overload prevention control (H70), and current limiter (F43), then check that the motor vibration is suppressed.</p> <ul style="list-style-type: none"> → Cancel the functions causing the vibration. → Readjust the data of the oscillation suppression gain (H80) currently set to appropriate values. <p>Check that the motor vibration is suppressed if you decrease the level of F26 (Motor sound (carrier frequency)) or set F27 (Motor sound (tone)) to "0".</p> <ul style="list-style-type: none"> → Decrease the carrier frequency (F26) or set the tone to "0" (F27=0).

[5] If grating sound can be heard from motor

Possible Causes	What to Check and Suggested Measures
(1) The carrier frequency was set too low.	<p>Check the data of function codes F26 (Motor sound (carrier frequency)) and F27 (Motor sound (tone)).</p> <ul style="list-style-type: none"> → Increase the carrier frequency (F26). → Readjust the setting of F27 to appropriate value.
(2) The ambient temperature of the inverter was too high (when automatic lowering of the carrier frequency was enabled by H98).	<p>Measure the temperature inside the enclosure of the inverter.</p> <ul style="list-style-type: none"> → If it is over 40°C, lower it by improving the ventilation. → Lower the temperature of the inverter by reducing the load. (In the case of a fan or a pump, lower the setting data of the frequency limiter (F15).) <p>Note: If you disable H98, an <i>OH1</i>, <i>OH3</i> or <i>OLU</i> alarm may occur.</p>
(3) Resonance with the load	<p>Check the precision of the mounting of the load or check whether there is resonance with the enclosure or likes.</p> <ul style="list-style-type: none"> → Disconnect the motor and run it without the inverter, and determine where the resonance comes from. Upon locating the cause, improve the characteristics of the source of the resonance. → Adjust the settings of C01 (Jump frequency 1) to C04 (Jump frequency (band)) so as to avoid continuous running in the frequency range causing resonance.

[6] The motor does not accelerate and decelerate at the set time.

Possible Causes	What to Check and Suggested Measures
(1) The inverter ran the motor by S-curve or curvilinear pattern.	Check the data of function code H07 (Acceleration/deceleration pattern). → Select the linear pattern (H07 = 0). → Shorten the acceleration/deceleration time (F07, F08).
(2) The current limiting prevented the output frequency from increasing (during acceleration).	Make sure that F43 (Current limiter (mode selection)) is set to "2: Enable during acceleration and at constant speed," then check that the setting of F44 (Current limiter (level)) is reasonable. → Readjust the setting of F44 to appropriate value, or disable the function of current limiter in F43. → Increase the acceleration/deceleration time (F07/F08).
(3) The automatic regenerative braking was active.	Check the data of function code H69 (Automatic deceleration). → Increase the deceleration time (F08).
(4) Overload	Measure the output current. → Lighten the load (In the case of a fan or a pump load, lower the setting data of the F15 (Frequency limiter (high)). (In winter, the load tends to increase.).
(5) Torque generated by the motor was insufficient.	Check that the motor starts running if the value of the torque boost (F09) is increased. → Increase the value of the torque boost (F09).
(6) An external frequency command is being used.	Check that there is no noise in the external signal wires. → Isolate the control signal wires from the main circuit wires as far as possible. → Use shielded wire or twisted wire for the control signal wires. → Connect a capacitor to the output terminal of the frequency command or insert a ferrite core in the signal wire. (Refer to Chapter 2 Section 2.3.7 "Wiring for control circuit terminals.")
(7) The V2/PTC switch was turned to PTC (when V2 was being used).	Check whether control terminal [V2] is not set to the PTC thermistor input mode. → Turn the V2/PTC switch on the printed circuit board to V2.

[7] Even if the power recovers after a momentary power failure, the motor does not restart.

Possible Causes	What to Check and Suggested Measures
(1) The data of function code F14 is either 0 or 1.	Check if an undervoltage trip occurs. → Change the data of function code F14 (Restart mode after momentary power failure (mode selection)) to 3, 4 or 5.
(2) The run command stayed off even after power has been restored.	Check the input signal with Menu #4 "I/O Checking" using the keypad. → Check the power recovery sequence with an external circuit. If necessary, consider the use of a relay that can keep the run command on. While in 3-wire operation, the power source to the inverter's control circuit went down because of a long momentary power failure; or, the (HOLD) signal was turned OFF once. → Change the design or the setting so that a run command can be issued again within 2 seconds after power has been restored.

6.2.2 Problems with inverter settings



[1] Nothing appears on the LED monitor.

Possible Causes	What to Check and Suggested Measures
(1) No power supplied to the inverter (main circuit power, auxiliary power for control circuit).	<p>Check the input voltage, output voltage and interphase voltage unbalance.</p> <p>→ Connect a molded case circuit breaker, an earth leakage circuit breaker (with overcurrent protection) or a magnetic contactor.</p> <p>→ Check for voltage drop, phase loss, poor connections, or poor contacts, and fix them if necessary.</p>
(2) The power for the control circuit did not reach a high enough level.	<p>Check if the short bar has been removed between terminals P1 and P (+) or if there is poor contact between the short bar and the terminals.</p> <p>→ Connect the short bar or DC reactor between terminals P1 and P (+) or retighten the screws.</p>
(3) The keypad was not properly connected to the inverter.	<p>Check whether the keypad is properly connected to the inverter.</p> <p>→ Remove the keypad, put it back, and see whether the problem persists.</p> <p>→ Replace the keypad with another one and check whether the problem persists.</p>
	<p>When running the inverter remotely, ensure that the extension cable is securely connected both to the keypad and to the inverter.</p> <p>→ Disconnect the cable, reconnect it, and see whether the problem persists.</p> <p>→ Replace the keypad with another one and check whether the problem persists.</p>

[2] The desired menu is not displayed.

Causes	Check and Measures
(1) The limiting menus function was not selected appropriately.	<p>Check the data of function code E52 (Keypad (menu display mode)).</p> <p>→ Change the data of function code E52 so that the desired menu can be displayed.</p>

[3] Data of function codes cannot be changed

Possible Causes	What to Check and Suggested Measures
(1) An attempt was made to change function code data that cannot be changed when the inverter is running.	<p>Check if the inverter is running with Menu #3 "Drive Monitoring" using the keypad and then confirm whether the data of the function codes can be changed when the motor is running by referring to the function code tables.</p> <p>→ Stop the motor then change the data of the function codes.</p>
(2) The data of the function codes is protected.	<p>Check the data of function code F00 (Data protection).</p> <p>→ Change the setting of F00 from "1" to "0."</p>
(3) The WE-KP command ("Enable editing of function code data from keypad") is not input though it has been assigned to a digital input terminal.	<p>Check the data of function codes E01, E02, E03, E04, E05, E98 and E99 and the input signals with Menu #4 "I/O Checking" using the keypad.</p> <p>→ Change the setting of F00 from "1" to "0," or input a WE-KP command through a digital input terminal.</p>
(4) The  key was not pressed.	<p>Check whether you have pressed the  key after changing the function code data.</p> <p>→ Press the  key after changing the function code data.</p>
(5) The setting data of function code F02 could not be changed.	<p>The inputs to the terminals of (FWD) and (REV) commands are concurrently turned ON.</p> <p>→ Turn OFF both (FWD) and (REV).</p>

6.3 If an Alarm Code Appears on the LED Monitor

■ Quick reference table of alarm codes

Alarm code	Name	Refer to	Alarm code	Name	Refer to
<i>OC1</i>	Instantaneous overcurrent	6-8	<i>PbF</i>	Charger circuit fault	6-13
<i>OC2</i>			<i>OL1</i>	Electronic thermal overload relay	6-14
<i>OC3</i>			<i>OLU</i>	Overload	6-14
<i>EF</i>	Ground fault	6-9	<i>Er1</i>	Memory error	6-15
<i>OU1</i>	Overvoltage	6-9	<i>Er2</i>	Keypad communications error	6-15
<i>OU2</i>			<i>Er3</i>	CPU error	6-15
<i>OU3</i>			<i>Er4</i>	Option card communications error	6-16
<i>LU</i>	Undervoltage	6-10	<i>Er5</i>	Option card error	6-16
<i>Lin</i>	Input phase loss	6-10	<i>Er6</i>	Incorrect operation error	6-16
<i>OPL</i>	Output phase loss	6-11	<i>Er7</i>	Tuning error	6-17
<i>OH1</i>	Heat sink overheat	6-11	<i>Er8</i>	RS485 communications error	6-17
<i>OH2</i>	Alarm issued by an external device	6-12	<i>ErF</i>	Data saving error during undervoltage	6-18
<i>OH3</i>	Inside of the inverter overheat	6-12	<i>ErP</i>	RS485 communications error (Option card)	6-18
<i>OH4</i>	Motor protection (PTC thermistor)	6-12	<i>ErH</i>	LSI error (Power PCB)	6-19
<i>FUS</i>	Fuse blown	6-13	<i>CoF</i>	Terminal [C1] wire break	6-19

[1] *OCn* Instantaneous overcurrent

Problem The inverter momentary output current exceeded the overcurrent level.

OC1 Overcurrent occurred during acceleration.

OC2 Overcurrent occurred during deceleration.

OC3 Overcurrent occurred when running at a constant speed.

Possible Causes	What to Check and Suggested Measures
(1) The inverter output terminals were short-circuited.	Remove the wires connected to the inverter output terminals (U, V, and W) and measure the interphase resistance of the wires. Check if the resistance is too low. → Remove the part that short-circuited (including replacement of the wires, relay terminals and motor).
(2) Ground faults occurred at the inverter output terminals.	Remove the wires connected to the inverter output terminals (U, V, and W) and perform a Megger test. → Remove the part that short-circuited (including replacement of the wires, relay terminals and motor).
(3) Loads were too heavy.	Measure the motor current with a measuring device, and to trace the current trend. Therefore, use this information to judge if the trend is over the calculated load value for your system design. → If the load is too heavy, decrease it or raise the inverter capacity. Trace the current trend and check if there are any sudden changes in the current. → If there are any sudden changes, make the load variation smaller or raise the inverter capacity. → Enable instantaneous overcurrent limiting (H12 = 1).

Possible Causes	What to Check and Suggested Measures
(4) The value set for torque boost (F09) was too large. (F37 = 0, 1, 3, or 4)	Check that the output current decreases and the motor does not come to stall if you set a lower value than the current one for F09. → Lower the value for torque boost (F09) if the motor is not going to stall.
(5) The acceleration/ deceleration time was too short.	Check that the motor generates enough torque required during acceleration/deceleration. That torque is calculated from the moment of inertia for the load and the acceleration/deceleration time. → Increase the acceleration/deceleration time (F07 and F08). → Enable current limiting (F43). → Raise the inverter capacity.
(6) Malfunction caused by noise	Check if noise control measures are appropriate (e.g., correct grounding and routing of control and main circuit wires). → Implement noise control measures. For details, refer to "Appendix A" of the FRENIC-Eco User's Manual (MEH456). → Enable the auto-resetting (H04). → Connect a surge absorber to the coil or solenoid of the magnetic contactor causing the noise.

[2] *EF* Ground fault (90 kW or above)

Problem A ground fault current flew from the output terminal of the inverter.

Possible Causes	What to Check and Suggested Measures
(1) The output terminal of the inverter is short-circuited to the ground (ground fault, or earthed).	Disconnect the wires from the output terminals ([U], [V], and [W]) and perform a megger test. → Remove the earthed path (including the replacement of the wires, the terminals, or the motor as necessary).

[3] *OLh* Overvoltage

Problem The DC link bus voltage was over the detection level of overvoltage.

OL1 Overvoltage occurs during the acceleration.

OL2 Overvoltage occurs during the deceleration.

OL3 Overvoltage occurs during running at constant speed.

Possible Causes	What to Check and Suggested Measures
(1) The power supply voltage was over the range of the inverter's specifications.	Measure the input voltage. → Decrease the voltage to within that of the specifications.
(2) A surge current entered the input power source.	If within the same power source a phase-advancing capacitor is turned ON or OFF or a thyristor converter is activated, a surge (temporary precipitous rise in voltage or current) may be caused in the input power. → Install a DC reactor.
(3) The deceleration time was too short for the moment of inertia for load.	Recalculate the deceleration torque from the moment of inertia for load and the deceleration time. → Increase the deceleration time (F08). → Enable the regenerative braking (H69 = 3), or automatic deceleration (H71 = 1). → Set the rated voltage (at base frequency) (F05) to "0" to improve braking ability.
(4) The acceleration time was too short.	Check if the overvoltage alarm occurs after rapid acceleration. → Increase the acceleration time (F07). → Select the S-curve pattern (H07).

Possible Causes	What to Check and Suggested Measures
(5) Braking load was too heavy.	Compare the braking torque of the load with that of the inverter. → Set the rated voltage (at base frequency) (F05) to 0 to improve braking ability.
(6) Malfunction caused by noise.	Check if the DC link bus voltage was below the protective level when the alarm occurred. → Improve noise control. For details, refer to "Appendix A" of the FRENIC-Eco User's Manual (MEH456). → Enable the auto-resetting (H04). → Connect a surge absorber to the coil or solenoid of the magnetic contactor causing the noise.

[4] $\underline{\underline{U}}$ Undervoltage

Problem DC link bus voltage was below the undervoltage detection level.

Possible Causes	What to Check and Suggested Measures
(1) A momentary power failure occurred.	→ Reset the alarm. → If you want to restart running the motor by not treating this condition as an alarm, set F14 to "3," "4" or "5," depending on the load.
(2) The power to the inverter was switched back on too soon (with F14 = 1).	Check if the power to the inverter was switched back on although its control circuit was still operating. → Switch ON the power again after the display on the keypad has disappeared.
(3) The power supply voltage did not reach the range of the inverter's specifications.	Measure the input voltage. → Increase the voltage to within that of the specifications.
(4) Peripheral equipment for the power circuit malfunctioned, or the connection was incorrect.	Measure the input voltage to find where the peripheral equipment malfunctioned or which connection is incorrect. → Replace any faulty peripheral equipment, or correct any incorrect connections.
(5) Other loads were connected to the same power source and required a large current to start running to the extent that it caused a temporary voltage drop on the supply side.	Measure the input voltage and check the voltage variation. → Reconsider the power system configuration.
(6) Inverter's inrush current caused the power voltage drop because power transformer capacity was insufficient.	Check if the alarm occurs when you switch on a molded case circuit breaker, an earth leakage circuit breaker (with overcurrent protection) or a magnetic contactor. → Reconsider the capacity of the power source transformer.

[5] $\underline{\underline{L}}$ Input phase loss

Problem Input phase loss occurred, or interphase voltage unbalance rate was large.

Possible Causes	What to Check and Suggested Measures
(1) Main circuit power input wires broken.	Measure the input voltage. → Repair or replace the wires.
(2) The terminal screws for the main circuit power input of the inverter were not tight enough.	Check if the screws on the inverter input terminals have become loose. → Tighten the terminal screws to the recommended torque.

Possible Causes	What to Check and Suggested Measures
(3) Interphase unbalance rate of three-phase voltage was too large.	Measure the input voltage. → Connect an AC reactor (ACR) to lower the voltage unbalance between input phases. → Raise the inverter capacity.
(4) Overload cyclically occurred.	Measure ripple wave of DC link bus voltage. → If the ripple is large, raise the inverter capacity
(5) Single-phase voltage was input to the inverter instead of three-phase voltage input.	Check the inverter type. → Apply three-phase power. FRENIC-Eco cannot be driven by single-phase power source.

 **Note** You can disable input phase loss protection using the function code H98.

[6] *OPL* Output phase loss

Problem Output phase loss occurred.

Possible Causes	What to Check and Suggested Measures
(1) Inverter output wires are broken.	Measure the output current. → Replace the output wires.
(2) Wires for motor winding are broken.	Measure the output current. → Replace the motor.
(3) The terminal screws for inverter output were not tight enough.	Check if any screws on the inverter output terminals have become loose. → Tighten the terminal screws to the recommended torque.
(4) A single-phase motor has been connected.	→ Single-phase motors cannot be used. Note that the FRENIC-Eco only drives three-phase induction motors.

[7] *OH* / Heat sink overheat

Problem Temperature around heat sink rose.

Possible Causes	What to Check and Suggested Measures
(1) Temperature around the inverter exceeded that of inverter specifications.	Measure the temperature around the inverter. → Lower the temperature around the inverter (e.g., ventilate the enclosure well).
(2) Air vent is blocked.	Check if there is sufficient clearance around the inverter. → Increase the clearance.
	Check if the heat sink is not clogged. → Clean the heat sink.
(3) Accumulated running time of the cooling fan exceeded the standard period for replacement, or the cooling fan malfunctioned.	Check the cumulative running time of the cooling fan. Refer to Chapter 3, Section 3.4.6 "Reading maintenance information – "Maintenance Information"." → Replace the cooling fan.
	Visually check whether the cooling fan rotates abnormally. → Replace the cooling fan.
(4) Load was too heavy.	Measure the output current. → Lighten the load (e.g. lighten the load before the overload protection occurs using the overload early warning (E34). (In winter, the load tends to increase.) → Decrease the motor sound (carrier frequency) (F26). → Enable the overload protection control (H70).

Note The 200V series inverters with a capacity of 45 kW or above and the 400V series inverters with a capacity of 55 kW or above each have a cooling fan/fans for heat sinks and a DC fan for internal air circulation (dispersing the heat generated inside the inverter). For their locations, refer to Chapter 1, Section 1.2 "External View and Terminal Blocks."

[8] *OH2* Alarm issued by an external device

Problem External alarm was inputted (THR).
(in case external alarm (THR) is assigned to one of digital input terminals [X1] through [X5], [FWD], or [REV])

Possible Causes	What to Check and Suggested Measures
(1) An alarm function of the external equipment was activated.	Inspect external equipment operation. → Remove the cause of the alarm that occurred.
(2) Connection has been performed incorrectly.	Check if the wire for the external alarm signal is correctly connected to the terminal to which the "Alarm from external equipment" has been assigned (Any of E01, E02, E03, E04, E05, E98, and E99 is set to "9"). → Connect the wire for the alarm signal correctly.
(3) Incorrect settings.	Check if the "Alarm from external equipment" has not been assigned to an unassigned terminal assigned (E01, E02, E03, E04, E05, E98, or E99). → Correct the assignment.
	Check whether the assignment (normal/negative logic) of the external signal agrees with that of thermal command (THR) set by E01, E02, E03, E04, E05, E98, and E99. → Ensure that the polarity matches.

[9] *OH3* Inside of the inverter overheat

Problem The temperature inside the inverter exceeded the allowable limit.

Possible Causes	What to Check and Suggested Measures
(1) The ambient temperature exceeded the allowable limit specified for the inverter.	Measure the ambient temperature. → Lower the ambient temperature by improving the ventilation.

[10] *OH4* Motor protection (PTC thermistor)

Problem Temperature of the motor rose abnormally.

Possible Causes	What to Check and Suggested Measures
(1) Temperature around the motor exceeded that of motor specifications.	Measure the temperature around the motor. → Lower the temperature.
(2) Cooling system for the motor malfunctioned.	Check if the cooling system of the motor is operating normally. → Repair or replace the cooling system of the motor.
(3) Load was too heavy.	Measure the output current. → Lighten the load (e.g., lighten the load before overload occurs using the overload early warning (E34) function) (In winter, the load tends to increase.). → Lower the temperature around the motor. → Increase the motor sound (carrier frequency) (F26).

Possible Causes	What to Check and Suggested Measures
(4) The set activation level (H27) of the PTC thermistor for motor overheat protection was inadequate.	Check the thermistor specifications and recalculate the detection voltage. → Reconsider the data of function code H27.
(5) A PTC thermistor and pull-up resistor were connected incorrectly or the resistance was inadequate.	Check the connection and the resistance of the pull-up resistor. → Correct the connections and replace the resistor with one with an appropriate resistance.
(6) The value set for the torque boost (F09) was too high.	Check the data of function code F09 and readjust the data so that the motor does not stall even if you set the data to a lower value. → Readjust the data of the function code F09.
(7) The V/f pattern did not match the motor.	Check if the base frequency (F04) and rated voltage at base frequency (F05) match the values on the nameplate on the motor. → Match the function code data to the values on the nameplate of the motor.
(8) Wrong settings	Although no PTC thermistor is used, the V2/PTC switch is turned to PTC, which means that the thermistor input is active on the PTC (H26). → Set H26 (PTC thermistor Input) to "0" (inactive).

[11] *F_{LS}* Fuse blown (90 kW or above)

Problem The fuse inside the inverter blew.

Possible Causes	What to Check and Suggested Measures
(1) The fuse blew because of a short-circuiting inside the inverter.	Check whether there has been any excess surge or noise coming from outside. → Take measures against surges and noise. → Have the inverter repaired.

[12] *F_{LF}* Charger circuit fault (45 kW or above (200 V Series), 55 kW or above (400 V Series))

Problem The magnetic contactor for short-circuiting the resistor for charging failed to work.

Possible Causes	What to Check and Suggested Measures
(1) Control power was not supplied to the magnetic contactor intended for short-circuiting the charging resistor.	Check whether, in normal connection of the main circuit (not connection via the DC link bus), the connector (CN) on the power supply printed circuit board is not inserted to [NC] . → Insert the connector to [FAN] .
	Check whether you have quickly turned the circuit breaker ON and OFF to confirm safety after cabling/wiring. → Wait until the DC link bus voltage has dropped to a sufficiently low level and then reset the current alarm, and turn ON the power again. (Do not turn the circuit breaker ON and OFF quickly.) (Turning ON the circuit breaker supplies power to the control circuit to the operation level (lighting LEDs on the keypad) in a short period. Immediately turning it OFF even retains the control circuit power for a time, while it shuts down the power to the magnetic contactor intended for short-circuiting the charging resistor since the contactor is directly powered from the main power.) Under such conditions, the control circuit can issue a turn-on command to the magnetic contactor, but the contactor not powered can produce nothing. This state is regarded as abnormal, causing an alarm.)

[13] / Electronic thermal overload relay

Problem Electronic thermal function for motor overload detection was activated.

Possible Causes	What to Check and Suggested Measures
(1) The characteristics of electronic thermal did not match those of the motor overload.	Check the motor characteristics. → Reconsider the data of function codes P99, F10 and F12. → Use an external thermal relay.
(2) Activation level for the electronic thermal relay was inadequate.	Check the continuous allowable current of the motor. → Reconsider and change the data of function code F11.
(3) The acceleration/ deceleration time was too short.	Check that the motor generates enough torque for acceleration/ deceleration. This torque is calculated from the moment of inertia for the load and the acceleration/ deceleration time. → Increase the acceleration/ deceleration time (F07 and F08).
(4) Load was too heavy.	Measure the output current. → Lighten the load (e.g., lighten the load before overload occurs using the overload early warning (E34)). (In winter, the load tends to increase.)

[14] Overload

Problem Temperature inside inverter rose abnormally.

Possible Causes	What to Check and Suggested Measures
(1) Temperature around the inverter exceeded that of inverter specifications.	Measure the temperature around the inverter. → Lower the temperature (e.g., ventilate the enclosure well).
(2) The torque boost setting (F09) was too high.	Check the setting of F09 (torque boost) and make sure that lowering it would not cause the motor to stall. → Adjust the setting of F09.
(3) The acceleration/ deceleration time was too short.	Recalculate the required acceleration/deceleration torque and time from the moment of inertia for the load and the deceleration time. → Increase the acceleration/deceleration time (F07 and F08).
(4) Load was too heavy.	Measure the output current. → Lighten the load (e.g., lighten the load before overload occurs using the overload early warning (E34)). (In winter, the load tends to increase.) → Decrease the motor sound (carrier frequency) (F26). → Enable overload protection control (H70).
	Check if there is sufficient clearance around the inverter. → Increase the clearance.
(5) Air vent is blocked.	Check if the heat sink is not clogged. → Clean the heat sink.
	Check the cumulative running time of cooling fan. Refer to Chapter 3, Section 3.4.6 " Reading maintenance information – "Maintenance Information"." → Replace the cooling fan.
(6) The service life of the cooling fan has expired or the cooling fan malfunctioned.	Visually check that the cooling fan rotates normally. → Replace the cooling fan.
	Measure the leakage current. → Insert an output circuit filter (OFL).
(7) The wires to the motor are too long and caused a large amount of current to leak from them.	

[15] E_r / Memory error

Problem Error occurred in writing the data to the memory in the inverter.

Possible Causes	What to Check and Suggested Measures
(1) While the inverter was writing data (especially initializing data or copying data), power supply was turned OFF and the voltage for the control circuit dropped.	<p>Check if pressing the PRO RES key resets the alarm after the function code data are initialized by setting the data of H03 to 1.</p> <p>→ Return the initialized function code data to their previous settings, then restart the operation.</p>
(2) A high intensity noise was given to the inverter while data (especially initializing data) was being written.	<p>Check if appropriate noise control measures have been implemented (e.g., correct grounding and routing of control and main circuit wires). Also, perform the same check as described in (1) above.</p> <p>→ Improve noise control. Alternatively, return the initialized function code data to their previous settings, then restart the operation.</p>
(3) The control circuit failed.	<p>Initialize the function code data by setting H03 to 1, then reset the alarm by pressing the PRO RES key and check that the alarm goes on.</p> <p>→ This problem was caused by a problem of the printed circuit board (PCB) (on which the CPU is mounted). Contact your Fuji Electric representative.</p>

[16] E_r2 Keypad communications error

Problem A communications error occurred between the remote keypad and the inverter.

Possible Causes	What to Check and Suggested Measures
(1) Break in the communications cable or poor contact.	<p>Check continuity of the cable, contacts and connections.</p> <p>→ Re-insert the connector firmly.</p> <p>→ Replace the cable.</p>
(2) A high intensity noise was given to the inverter.	<p>Check if appropriate noise control measures have been implemented (e.g., correct grounding and routing of control and main circuit wires).</p> <p>→ Improve noise control. For details, refer to "Appendix A" of the FRENIC-Eco User's Manual (MEH456).</p>
(3) The keypad malfunctioned.	<p>Check that alarm E_r2 does not occur if you connect another keypad to the inverter.</p> <p>→ Replace the keypad.</p>

[17] E_r3 CPU error

Problem A CPU error (e.g. erratic CPU operation) occurred.

Possible Causes	What to Check and Suggested Measures
(1) A high intensity noise was given to the inverter.	<p>Check if appropriate noise control measures have been implemented (e.g. correct grounding and routing of control and main circuit wires and communications cable).</p> <p>→ Improve noise control.</p>

[18] E_r-4 Option card communications error

Problem A communications error occurred between the option card and the inverter.

Possible Causes	What to Check and Suggested Measures
(1) There was a problem with the connection between the bus option card and the inverter.	Check whether the connector on the bus option card is properly mating with the connector of the inverter. → Reload the bus option card into the inverter.
(2) There was a high intensity noise from outside.	Check whether appropriate noise control measures have been implemented (e.g. correct grounding and routing of control and main circuit wires and communications cable). → Reinforce noise control measures.

[19] E_r-5 Option card error

An error detected by the option card. Refer to the instruction manual of the option card for details.

[20] E_r-6 Incorrect operation error

Problem You incorrectly operated the inverter.

Possible Causes	What to Check and Suggested Measures
(1) The  key was pressed when H96 = 1 or 3.	Although a Run command had been inputted from the input terminal or through the communications port, the inverter was forced to decelerate to stop. → If this was not intended, check the setting of H96.
(2) The start check function was activated when H96 = 2 or 3.	With a Run command being inputted, any of the following operations has been performed: - Turning the power ON - Releasing the alarm - Switching the enable communications link (LE) operation → Review the running sequence to avoid input of a Run command when this error occurs. If this was not intended, check the setting of H96. (To reset the alarm, turn the Run command OFF.)
(3) The forced stop digital input (STOP) was turned ON.	Turning ON the forced stop digital input (STOP) decelerated the inverter to stop according to the specified deceleration period (H96). → If this was not intended, check the settings of E01 through E05 on terminals X1 through X5.

[21] *E-7* Tuning error

Problem Auto-tuning failed.

Possible Causes	What to Check and Suggested Measures
(1) A phase was missing (There was a phase loss) in the connection between the inverter and the motor.	→ Properly connect the motor to the inverter.
(2) V/f or the rated current of the motor was not properly set.	Check whether the data of function codes F04, F05, H50, H51, P02, and P03 agrees with the specifications of the motor.
(3) The connection between the inverter and the motor was too long.	Check whether the connection length between the inverter and the motor is not exceeding 50m. → Review, and if necessary, change the layout of the inverter and the motor to shorten the connection wire. Alternatively, minimize the connection wire length without changing the layout. → Disable both auto-tuning and auto-torque (set F37 to "1").
(4) The rated capacity of the motor was significantly different from that of the inverter.	Check whether the rated capacity of the motor is smaller than that of the inverter by three or more orders of class or larger by two or more orders of class. → Check whether it is possible to replace the inverter with one with an appropriate capacity. → Manually specify the values for the motor parameters P06, P07, and P08. → Disable both auto-tuning and auto-torque boost (set F37 to "1").
(5) The motor was a special type such as a high-speed motor.	→ Disable both auto-tuning and auto-torque boost (set F37 to "1").

 For details of tuning errors, refer to "Errors during Tuning" in Chapter 4, Section 4.1.3 "Preparation before running the motor for a test – Setting function code data."

[22] *E-8* RS485 communications error

Problem A communications error occurred during RS485 communications.

Possible Causes	What to Check and Suggested Measures
(1) Conditions for communications differ between the inverter and host equipment.	Compare the settings of the y codes (y01 to y10) with those of the host equipment. → Correct any settings that differ.
(2) Even though no response error detection time (y08) has been set, communications is not performed within the specified cycle.	Check the host equipment. → Change the settings of host equipment software, or make the no response error detection time be ignored (y08=0).
(3) Host equipment (e.g., PLCs and personal computers) did not operate due to incorrect settings and/or defective software/hardware.	Check the host equipment. → Remove the cause of the equipment error.
(4) Relay converters (e.g., RS485 relay converter) did not operate due to incorrect connections and settings, or defective hardware.	Check the RS485 relay converter (e.g., check for poor contact). → Change the various RS485 converter settings, reconnect the wires, or replace hardware (such as recommended devices) as appropriate.
(5) Broken communications cable or poor contact.	Check continuity of the cable, contacts and connections. → Replace the cable.

Possible Causes	What to Check and Suggested Measures
(6) A high intensity noise was given to the inverter.	<p>Check if appropriate noise control measures have been implemented (e.g., correct grounding and routing of control and main circuit wires).</p> <p>→ Improve noise control.</p> <p>→ Improve noise reduction measures on the host side.</p> <p>→ Replace the RS485 relay converter with a recommended insulated converter.</p>

[23] E_rF Data saving error during undervoltage

Problem The inverter was unable to save data such as the frequency commands and PID process command set through the keypad when the power was switched off.

Possible Causes	What to Check and Suggested Measures
(1) The control circuit voltage dropped suddenly while data was being saved when the power was turned OFF, because the DC link bus was rapidly discharged.	<p>Check how long it takes for the DC link bus voltage to drop to the preset voltage when power is turned OFF.</p> <p>→ Remove whatever is causing the rapid discharge of the DC link bus electricity. After pressing the PRG/RESET key and releasing the alarm, set, using a remote keypad, the data of the relevant function codes (such as the frequency commands and PID process command) back to the original values and then restart the operation.</p>
(2) A high intensity noise affected the operation of the inverter while data was being saved when the power was turned OFF.	<p>Check if appropriate noise control measures have been implemented (e.g., correct grounding and routing of control and main circuit wires).</p> <p>→ Improve noise control. After pressing the PRG/RESET key and releasing the alarm, set, using a remote keypad, the data of the relevant function codes (such as the frequency commands and PID process command) back to the original values and then restart the operation.</p>
(3) The control circuit failed.	<p>Check if E_rF occurs each time power is switched on.</p> <p>→ This problem was caused by a problem of the printed circuit board (PCB) (on which the CPU is mounted). Contact your Fuji Electric representative.</p>

[24] E_rP RS485 communications error (Option card)

Problem A communications error occurred during RS485 communications (Option card).

Possible Causes	What to Check and Suggested Measures
(1) Conditions for communications differ between the inverter and host equipment.	<p>Compare the settings of the y codes (y01 to y10) with those of the host equipment.</p> <p>→ Correct any settings that differ.</p>
(2) Even though no response error detection time (y18) has been set, communications did not occur cyclically.	<p>Check the host equipment.</p> <p>→ Change the settings of host equipment software, or make the no response error detection time invalid (y18=0).</p>
(3) Host equipment (e.g., PLCs and personal computers) did not operate due to incorrect settings and/or defective software/hardware.	<p>Check the host equipment.</p> <p>→ Remove the cause of the equipment error.</p>
(4) Relay converters (e.g., RS485 relay converter) did not operate due to incorrect connections and settings, and defective hardware.	<p>Check the RS485 relay converter (e.g., check for poor contact).</p> <p>→ Change the various RS485 converter settings, reconnect the wires, or replace hardware (such as recommended devices) as appropriate.</p>

Possible Causes	What to Check and Suggested Measures
(5) Broken communications cable or poor contact.	Check continuity of the cable, contacts and connections. → Replace the cable.
(6) A high intensity noise was given to the inverter.	Check if appropriate noise control measures have been implemented (e.g., correct grounding and routing of control and main circuit wires). → Improve noise control. → Improve noise reduction measures on the host side. → Replace the RS485 relay converter with a recommended insulated converter.
(7) The RS485 communications card malfunctioned.	→ Replace the card.

[25] *E_rH* LSI error (Power PCB) (45 kW or above (200 V series); 55 kW or above (400 V series))

Problem An error occurred in the LSI on the power printed circuit board (power PCB).

Possible Causes	What to Check and Suggested Measures
(1) The capacity is not set properly on the control printed circuit board.	The inverter capacity needs to be modified again. → Contact your Fuji Electric representative.
(2) The contents of the memory on the power supply printed circuit board are corrupted.	The power supply printed circuit board needs to be replaced. → Contact your Fuji Electric representative.
(3) Connection problem between the control printed circuit board and the power supply printed circuit board	Either the control printed circuit board or the power supply printed circuit board needs to be replaced. → Contact your Fuji Electric representative.

[26] *L_oF* Terminal [C1] wire break



Problem The terminal [C1] wire is broken.

Possible Causes	What to Check and Suggested Measures
(1) The wiring to the terminal [C1] is broken.	Check whether the wire is broken. → Replace the wire.
(2) Wrong wiring	Check whether the wire is connected across the terminals [C1] and [11]. → Correct the wiring.
(3) Wrong setting	Check whether H91 is properly set. → Correct the setting.

6.4 If an Abnormal Pattern Appears on the LED Monitor while No Alarm Code is Displayed

[1] ---- (center bar) appears

Problem A center bar (----) has appeared on the LCD monitor.

Possible Causes	What to Check and Suggested Measures
<p>(1) When PID control had been disabled (J01=0), you changed E43 (display selection) to 10 or 12.</p> <p>You disabled PID control (J01=0) when the LED monitor had been set to display the PID final command value or PID feedback value by pressing the  key.</p>	<p>Make sure that when you wish to view other monitor items, E43 is not set to "10: PID process command (final)" or "12: PID feedback value."</p> <p>→ Set E43 to a value other than "10" or "12."</p> <p>Make sure that when you wish to view a PID process command or a PID feedback value, PID control is still in effect or J01 is not set to 0.</p> <p>→ Set J01 to "1: Enable (normal operation)" or "2: Enable (inverse operation)."</p>
<p>(2) Connection to the keypad was in poor connection.</p>	<p>Prior to proceed, check that pressing the  key does not take effect for the LED display.</p> <p>Check connectivity of the extension cable for the keypad used in remote operation.</p> <p>→ Replace the cable.</p>

[2] _ _ _ _ (under bar) appears

Problem An under bar (_ _ _ _) appeared on the LED monitor when you pressed the  key or entered a run forward command (FWD) or a run reverse command (REV). The motor did not start.

Possible Causes	What to Check and Suggested Measures
<p>(1) The voltage of the DC link bus was low.</p>	<p>Select <u>5.01</u> under Menu #5 "Maintenance Information" in Programming mode on the keypad, and check the voltage of the DC link bus, which should be: 200 VDC or below for 3-phase 200V, and 400 VDC or below for 3-phase 400V.</p> <p>→ Connect the inverter to a power supply that meets its input specifications.</p>
<p>(2) The main power is not ON, while the auxiliary input power to the control circuit is supplied.</p>	<p>Check that the main power is turned ON.</p> <p>→ If it is not ON, turn it ON.</p>

[3] [] appears

Problem Parentheses ([]) has appeared on the screen while the keypad displaying the Drive Monitor.

Possible Causes	What to Check and Suggested Measures
<p>(1) The data to be displayed could not fit the LED monitor (e.g. overflow).</p>	<p>Check that the product of the output frequency and the display coefficient (E50) does not exceed 9999.</p> <p>→ Adjust the setting of E50.</p>

Chapter 7 MAINTENANCE AND INSPECTION

Perform daily and periodic inspection to avoid trouble and keep reliable operation for a long time. Take care of the following items during work.

WARNING

- Before proceeding to the maintenance/inspection jobs, turn OFF the power and wait more than five minutes for models of 30 kW or below, or ten minutes for models of 37 kW or above. Make sure that the LED monitor and charging lamp (on models of 37 kW or above) are turned OFF. Further, make sure, using a multimeter or a similar instrument, that the DC link bus voltage between the terminals P (+) and N (-) has dropped below the safe voltage (+25 VDC).

Electric shock may occur.

- Maintenance, inspection, and parts replacement should be made only by authorized persons.
- Take off the watch, rings and other metallic matter before starting work.
- Use insulated tools.
- Never modify the inverter.

Electric shock or injuries could occur.

7.1 Daily Inspection

Visually inspect errors in the state of operation from the outside without removing the covers while the inverter operates or while it is turned ON.

- Check if the expected performance (satisfying the standard specification) is obtained.
- Check if the surrounding environment satisfies Chapter 2, Section 2.1 "Operating Environment."
- Check that the LED monitor displays normally.
- Check for abnormal noise, odor, or excessive vibration.
- Check for traces of overheat, discoloration and other defects.

7.2 Periodic Inspection

Perform periodic inspection by following the items of the list of periodic inspection in Table 7.1. Before performing periodic inspection, be sure to stop the motor, turn OFF the inverter, and shut down power supply. Then remove the covers of the control and main circuit terminal blocks.

Table 7.1 List of Periodic Inspections

Check part	Check item	How to inspect	Evaluation criteria
Environment	1) Check the ambient temperature, humidity, vibration and atmosphere (dust, gas, oil mist, or water drops). 2) Check if tools or other foreign matter or dangerous objects are left around the equipment.	1) Check visually or measure using apparatus. 2) Visual inspection	1) The standard specification must be satisfied. 2) No foreign or dangerous objects are left.
Voltage	Check if the voltages of the main and control circuit are correct.	Measure the voltages using a multimeter or the like.	The standard specification must be satisfied.
Keypad	1) Check if the display is clear. 2) Check if there is missing parts in the characters.	1), 2) Visual inspection	1), 2) The display can be read and there is no fault.

Table 7.1 Continued

Check part		Check item	How to inspect	Evaluation criteria
Structure such as frame and cover		1) Abnormal noise and excessive vibration 2) Loosen bolts (tightened parts) 3) Deformation and breakage 4) Discoloration and deformation caused by overheat 5) Check for foulness and dust.	1) Visual or hearing inspection 2) Retighten. 3), 4), 5) Visual inspection	1), 2), 3), 4), 5) No abnormalities
Main circuit	Common	1) Check if bolts and screws are tight and not missing. 2) Check the devices and insulators for deformation, cracks, breakage and discoloration caused by overheat and deterioration. 3) Check for foulness and dust.	1) Retighten. 2), 3) Visual inspection	1), 2), 3) No abnormalities
	Conductor and wire	1) Check the conductor for discoloration and distortion caused by overheat. 2) Check the sheath of the cable for cracks and discoloration.	1), 2) Visual inspection	1), 2) No abnormalities
	Terminal block	Check that the terminals are not damaged.	Visual inspection	No abnormalities
	Filtering capacitor	1) Check for electrolyte leakage, discoloration, cracks and swelling of the case. 2) Check if the safety valve does not protrude remarkably. 3) Measure the capacitance if necessary.	1), 2) Visual inspection 3) Measure discharge time with capacitance probe.	1), 2) No abnormalities 3) The discharge time is not shorter than time specified by the replacement manual.
	Transformer and reactor	Check for abnormal roaring noise and odor.	Hearing, visual and smelling inspection	No abnormalities
	Magnetic contactor and relay	1) Check for chatters during operation. 2) Check for rough contacts.	1) Hearing inspection 2) Visual inspection	1), 2) No abnormalities
Control circuit	Printed circuit board	1) Check for loose screws and connectors. 2) Check for odor and discoloration. 3) Check for cracks, breakage, deformation and remarkable rust. 4) Check the capacitors for electrolyte leaks and deformation.	1) Retighten. 2) Smelling and visual inspection 3), 4) Visual inspection	1), 2), 3), 4) No abnormalities
Cooling system	Cooling fan	1) Check for abnormal noise and excessive vibration. 2) Check for loose bolts. 3) Check for discoloration caused by overheat.	1) Hearing and visual inspection, or turn manually (be sure to turn the power OFF). 2) Retighten. 3) Visual inspection	1) Smooth rotation 2), 3) No abnormalities
	Ventilation path	Check the heat sink, intake and exhaust ports for clogging and foreign matter.	Visual inspection	No abnormalities

If the inverter is stained, wipe it off with a chemically neutral cloth to remove dust and use a vacuum cleaner.

7.3 List of Periodical Replacement Parts

Each part of the inverter has its own service life that will vary according to the environmental and operating conditions. It is recommended that the following parts be replaced at the specified intervals.

When the replacement is necessary, contact your Fuji Electric representative.

Note: The standard replacement interval differs by inverter's ROM version as listed below.

Table 7.2 Replacement Parts

Part name	Standard replacement intervals (Note)	
	ROM version earlier than 1400	ROM version 1400 or later
DC link bus capacitor	7 years	10 years
Electrolytic capacitors on the printed circuit boards	7 years	10 years
Cooling fan	7 years (5.5 kW or below) 4.5 years (7.5 to 30 kW) 3 years (37 kW or above)	10 years (5.5 kW or below) 10 years (7.5 to 30 kW) 7 years (37 kW or above)
Fuse	10 years (90 kW or above)	10 years (90 kW or above)

(Note) These replacement intervals are based on the estimated service life of the inverter at an ambient temperature of 40°C under 80% of full load. In environments with an ambient temperature above 40°C or a large amount of dust or dirt, the replacement intervals may need to be reduced.

7.3.1 Judgment on service life

(1) Viewing data necessary for judging service life; Measurement procedures

Through Menu #5 "Maintenance Information" in Programming mode, you can view on the keypad various data (as a guideline) necessary for judging whether key components such as the DC link bus capacitor, the electrolytic capacitor on the printed circuit board, and the cooling fan are approaching their service life.

① -1 Measuring the capacitance of the DC link bus capacitor (in comparison with that at factory shipment)

Measure the capacitance of the DC link bus capacitor according to the procedure given below. The result will be displayed on the keypad as a ratio (%) to the initial capacitance at the time of factory shipment.

----- Procedure for measuring capacitance -----

1) To ensure validity in the comparative measurement, put the condition of the inverter back to the state at factory shipment.

- Remove the option card (if already in use) from the inverter.
- In case another inverter is connected via the DC link bus to the P(+) and N(-) terminals of the main circuit, disconnect the wires. (You do not need to disconnect a DC reactor (optional), if any.)
- Disconnect power wires for the auxiliary input to the control circuit (R0, T0).
- In case the standard keypad has been replaced with a multi-function keypad after the purchase, put back the original standard keypad.
- Turn OFF all the digital input signals fed to terminals [FWD], [REV], and [X1] through [X5] of the control circuit.
- If a potentiometer is connected to terminal [13], disconnect it.
- If an external apparatus is attached to terminal [PLC], disconnect it.
- Ensure that transistor output signals ([Y1] - [Y3]) and relay output signals ([Y5A/C] and [30A/B/C]) will not be turned ON.

Note If negative logic is specified for the transistor output and relay output signals, they are considered ON when the inverter is not running. Specify positive logic for them.

- Keep the ambient temperature within 25 ±10°C.

2) Switch ON the main circuit power.

3) Confirm that the cooling fan is rotating and the inverter is in stopped state.

4) Switch OFF the main circuit power.

5) Start the measurement of the capacitance of the DC link bus capacitor. Make sure that ". . . ." appears on the LED monitor.

Note If ". . . ." does not appear on the LED monitor, the measurement will not start. Check the conditions listed in 1).

6) Once ". . . ." has disappeared from the LED monitor, switch ON the main circuit power again.

7) Select Menu #5 "Maintenance Information" in Programming mode and note the reading (relative capacitance (%)) of the DC link bus capacitor.

① -2 Measuring the capacitance of the DC link bus capacitor (during power-off time under ordinary operating condition)

In general, the discharging condition of the DC link bus capacitor during a power-off time under the ordinary operating condition at the end user's installation is different from that under which the initial measurement is conducted at the time of factory shipment. As a result, the measured data for the DC link bus capacitor may not be updated. A method is provided, therefore, that allows you to measure the capacitance of the DC link bus capacitor during an ordinary power-off time by taking on (assuming) its discharging condition during a power-off time under the ordinary operation condition at the end user's installation.

Presented below is the procedure for taking on the discharging condition during a power-off time under the ordinary operating condition at the end user's installation.

----- **Procedure for setting up measurement condition** -----

- 1) Set function code H98 (Protection/maintenance function) to enable the user to specify the judgment criteria for the service life of the DC link bus capacitor (Bit 3) (refer to function code H98).
- 2) Place the inverter in stopped state.
- 3) Place the inverter in the state of power-off under ordinary operating conditions.
- 4) Set both function codes H42 (Capacitance of DC link bus capacitor) and H47 (Initial capacitance of DC link bus capacitor) to "0000."
- 5) Switch OFF the inverter.

Measure the discharging time of the DC link bus capacitor and save the result in function code H47 (Initial capacitance of DC link bus capacitor).

The condition under which the measurement has been conducted will be automatically collected and saved. During the measurement, ". . . ." will appear on the LED monitor.

- 6) Switch ON the inverter again. Confirm that H42 (Capacitance of DC link bus capacitor) and H47 (Initial capacitance of DC link bus capacitor) hold right values. Move to Menu #5 "Maintenance Information" and confirm that the relative capacitance (ratio to full capacitance) is 100%.

 **Note** If the measurement has failed, "0001" is entered into both H42 and H47. Check whether there has been any mistake in operation and conduct the measurement again.

To change the settings back to the state at the time of factory shipment, set H47 (Initial capacitance of DC link bus capacitor) to "0002"; the original values will be restored.

Hereafter, each time the inverter is switched OFF, the discharging time of the DC link bus capacitor is automatically measured if the above condition is met.

 **Note** The condition given above produces a rather large measurement error. If this mode gives you a lifetime alarm, set H98 (Maintenance operation) back to the default setting (Bit 3 (Specify service life criteria for replacing the DC link bus capacitor) = 0) and conduct the measurement under the condition at the time of factory shipment.

② Electrolytic capacitor on the printed circuit board

Move to Menu #5 "Maintenance Information" in Programming mode and check the accumulated run time of the electrolytic capacitor on the printed circuit board. This value is calculated from the cumulative total number of hours a voltage has been applied on the electrolytic capacitor, adjusted with ambient temperature, and is used as the basis for judging whether it has reached its service life. The value is displayed on the LED monitor in units of 1000 hours.

③ Cooling fan

Select Menu #5 "Maintenance Information" and check the accumulated run time of the cooling fan. The inverter accumulates hours for which the cooling fan has run. The display is in units of 1000 hours. The accumulated time should be used just a guide since the actual service life will be significantly affected by the temperature and operation environment.

(2) Early warning of lifetime alarm

For the components listed in Table 7.3, the inverter can issue an early warning of lifetime alarm **LIFE** at one of the transistor output terminals ([Y1] to [Y3]) and relay contact terminals ([Y5A] - [Y5C] and [30A/B/C]) as soon as any component exceeds its judgment level.

Note: The judgment level differs by inverter's ROM version as listed below.

The early warning signal is also turned ON when a lock condition on the internal air circulation DC fan (on 200 V series inverters with 45 kW or above; on 400 V series inverters with 55 kW or above) has been detected.

Table 7.3 Criteria for Issuing a Lifetime Alarm

Inverter's ROM version	Version earlier than 1400	Version 1400 or later	Note
Parts to be replaced	Judgment level		
DC link bus capacitor	85% or lower of the capacitance than that of the factory setting		
Electrolytic capacitor on the printed circuit board	Accumulated run time ≥ 61000 hours	Accumulated run time ≥ 87000 hours	
	Accumulated run time ≥ 25000 hours	Accumulated run time ≥ 61000 hours	
Cooling fan	Accumulated run time ≥ 61000 hours	Accumulated run time ≥ 87000 hours	5.5 kW or below
	Accumulated run time ≥ 40000 hours	Accumulated run time ≥ 87000 hours	7.5 to 30 kW
	Accumulated run time ≥ 25000 hours	Accumulated run time ≥ 61000 hours	37 kW or above
(estimated service life at the inverter's ambient temperature of 40°C under 80% of full load)			

 Tip The inverter's ROM version can be checked on Menu #5 "Maintenance Information" (5.14).

7.4 Measurement of Electrical Amounts in Main Circuit







Because the voltage and current of the power supply (input, primary circuit) of the main circuit of the inverter and those of the motor (output, secondary circuit) include harmonic components, the readings may vary with the type of the meter. Use meters indicated in Table 7.4 when measuring with meters for commercial frequencies.

The power factor cannot be measured by a commercially available power-factor meter that measures the phase difference between the voltage and current. To obtain the power factor, measure the power, voltage and current on each of the input and output sides and calculate in the following formula.

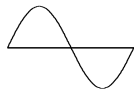
■ Three-phase input

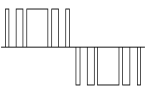
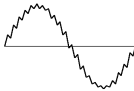
$$\text{Power factor} = \frac{\text{Electric power (W)}}{\sqrt{3} \times \text{Voltage (V)} \times \text{Current (A)}} \times 100 \%$$

Table 7.4 Meters for Measurement of Main Circuit

Item	Input (primary) side			Output (secondary) side			DC link bus voltage (P (+)-N (-))
Waveform	Voltage 		Current 	Voltage 		Current 	
Name of meter	Ammeter AR, AS, AT	Voltmeter VR, VS, VT	Wattmeter WR, WT	Ammeter Au, Av, Aw	Voltmeter Vu, Vv, Vw	Wattmeter Wu, Ww	DC voltmeter V
Type of meter	Moving iron type	Rectifier or moving iron type	Digital AC power meter	Digital AC power meter	Digital AC power meter	Digital AC power meter	Moving coil type
Symbol of meter			—	—	—	—	

 Note It is not recommended that meters other than a digital AC power meter be used for measuring the output voltage or output current since they may cause larger measurement errors or, in the worst case, they may be damaged.

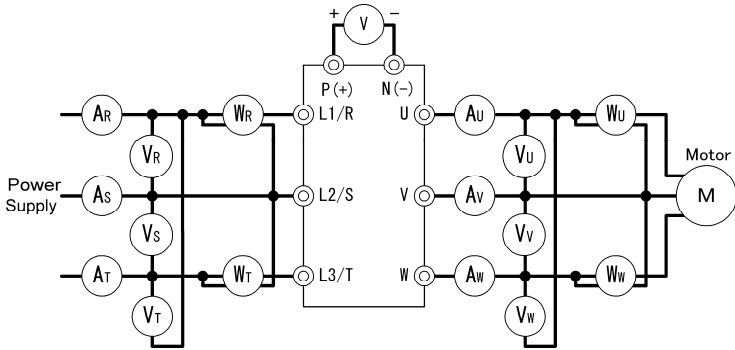

Figure 7.1 Connection of Meters

7.5 Insulation Test

Because an insulation test is made in the factory before shipment, avoid a Megger test.

If a Megger test is unavoidable, follow the procedure below. Because a wrong test procedure will cause breakage of the inverter, take sufficient care.

A dielectric strength test will cause breakage of the inverter similarly to the Megger test if the test procedure is wrong. When the dielectric strength test is necessary, contact your Fuji Electric representative.

(1) Megger test of main circuit

- 1) Use a 500 VDC Megger and shut off the main power supply without fail during measurement.
- 2) If the test voltage leaks to the control circuit due to the wiring, disconnect all the control wiring.
- 3) Connect the main circuit terminals with a common cable as shown in Figure 7.2.
- 4) The Megger test must be limited to across the common line of the main circuit and the ground terminal (⊕).
- 5) 5 MΩ (1 MΩ for the EMC filter built-in type of inverters) or a larger value displayed at the Megger indicates a correct state. (The value is for a discrete inverter.)

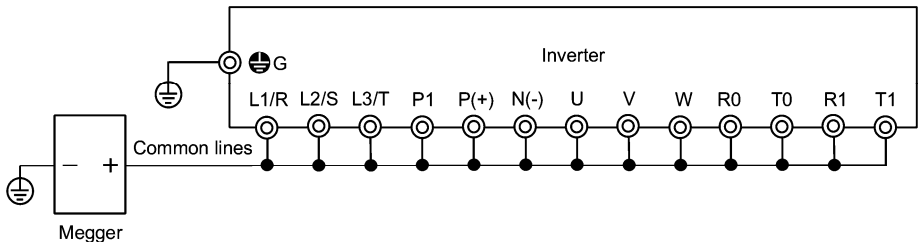

Figure 7.2 Megger Test

(2) Dielectric strength test of control circuit

Do not perform a Megger test or dielectric strength test for the control circuit. Prepare a high resistance range tester for the control circuit.

- 1) Disconnect all the external wiring from the control circuit terminals.
- 2) Perform a continuity test to the ground. 1 MΩ or a larger measurement indicates a correct state.

(3) Dielectric strength test of external main circuit and sequence control circuit

Disconnect all the inverter terminals so that the test voltage is not applied.

7.6 Inquiries about Product and Guarantee

7.6.1 When making an inquiry

Upon breakage of the product, uncertainties, failure or inquiries, inform your Fuji Electric representative of the following information.

- 1) Inverter type (Refer to Chapter 1, Section 1.1.)
- 2) SER No. (serial number of equipment) (Refer to Chapter 1, Section 1.1.)
- 3) Function codes and their data that you changed (Refer to Chapter 3, Section 3.4.3.)
- 4) ROM version (Refer to Chapter 3, Section 3.4.6.)
- 5) Date of purchase
- 6) Inquiries (for example, point and extent of breakage, uncertainties, failure phenomena, and other circumstances)
- 7) Production year (Refer to Chapter 1, Section 1.1.)

7.6.2 Product warranty

To all our customers who purchase Fuji Electric Systems' products:

Please take the following items into consideration when placing your order.

When requesting an estimate and placing your orders for the products included in these materials, please be aware that any items such as specifications which are not specifically mentioned in the contract, catalog, specifications or other materials will be as mentioned below.

In addition, the products included in these materials are limited in the use they are put to and the place where they can be used, etc., and may require periodic inspection. Please confirm these points with your sales representative or directly with this company.

Furthermore, regarding purchased products and delivered products, we request that you take adequate consideration of the necessity of rapid receiving inspections and of product management and maintenance even before receiving your products.

[1] Free of charge warranty period and warranty range

(1) Free of charge warranty period

- 1) The product warranty period is "1 year from the date of purchase" or 24 months from the manufacturing date imprinted on the name place, whichever date is earlier.
- 2) However, in cases where the use environment, conditions of use, use frequency and times used, etc., have an effect on product life, this warranty period may not apply.
- 3) Furthermore, the warranty period for parts restored by Fuji Electric's Service Department is "6 months from the date that repairs are completed."

(2) Warranty range

- 1) In the event that breakdown occurs during the product's warranty period which is the responsibility of Fuji Electric, Fuji Electric will replace or repair the part of the product that has broken down free of charge at the place where the product was purchased or where it was delivered. However, if the following cases are applicable, the terms of this warranty may not apply.
 - ① The breakdown was caused by inappropriate conditions, environment, handling or use methods, etc. which are not specified in the catalog, operation manual, specifications or other relevant documents.
 - ② The breakdown was caused by the product other than the purchased or delivered Fuji's product.
 - ③ The breakdown was caused by the product other than Fuji's product, such as the customer's equipment or software design, etc.
 - ④ Concerning the Fuji's programmable products, the breakdown was caused by a program other than a program supplied by this company, or the results from using such a program.
 - ⑤ The breakdown was caused by modifications or repairs affected by a party other than Fuji Electric.
 - ⑥ The breakdown was caused by improper maintenance or replacement using consumables, etc. specified in the operation manual or catalog, etc.
 - ⑦ The breakdown was caused by a science or technical problem that was not foreseen when making practical application of the product at the time it was purchased or delivered.

- ⑧ The product was not used in the manner the product was originally intended to be used.
 - ⑨ The breakdown was caused by a reason which is not this company's responsibility, such as lightning or other disaster.
- 2) Furthermore, the warranty specified herein shall be limited to the purchased or delivered product alone.
- 3) The upper limit for the warranty range shall be as specified in item (1) above and any damages (damage to or loss of machinery or equipment, or lost profits from the same, etc.) consequent to or resulting from breakdown of the purchased or delivered product shall be excluded from coverage by this warranty.

(3) Trouble diagnosis

As a rule, the customer is requested to carry out a preliminary trouble diagnosis. However, at the customer's request, this company or its service network can perform the trouble diagnosis on a chargeable basis. In this case, the customer is asked to assume the burden for charges levied in accordance with this company's fee schedule.

[2] Exclusion of liability for loss of opportunity, etc.

Regardless of whether a breakdown occurs during or after the free of charge warranty period, this company shall not be liable for any loss of opportunity, loss of profits, or damages arising from special circumstances, secondary damages, accident compensation to another company, or damages to products other than this company's products, whether foreseen or not by this company, which this company is not be responsible for causing.

[3] Repair period after production stop, spare parts supply period (holding period)

Concerning models (products) which have gone out of production, this company will perform repairs for a period of 7 years after production stop, counting from the month and year when the production stop occurs. In addition, we will continue to supply the spare parts required for repairs for a period of 7 years, counting from the month and year when the production stop occurs. However, if it is estimated that the life cycle of certain electronic and other parts is short and it will be difficult to procure or produce those parts, there may be cases where it is difficult to provide repairs or supply spare parts even within this 7-year period. For details, please confirm at our company's business office or our service office.

[4] Transfer rights

In the case of standard products which do not include settings or adjustments in an application program, the products shall be transported to and transferred to the customer and this company shall not be responsible for local adjustments or trial operation.

[5] Service contents

The cost of purchased and delivered products does not include the cost of dispatching engineers or service costs. Depending on the request, these can be discussed separately.

[6] Applicable scope of service

Above contents shall be assumed to apply to transactions and use of the country where you purchased the products.

Consult the local supplier or Fuji for the detail separately.

Chapter 8 SPECIFICATIONS

8.1 Standard Models

8.1.1 Three-phase 200 V series

Item		Specifications																
Type (FRN_ _ _ F1S-2□)		0.75	1.5	2.2	3.7	5.5	7.5	11	15	18.5	22	30	37	45	55	75	90	110
Nominal applied motor (kW) *1		0.75	1.5	2.2	3.7	5.5	7.5	11	15	18.5	22	30	37	45	55	75	90	110
Output ratings	Rated capacity (kVA) *2	1.6	2.6	4.0	6.3	9.0	12	17	22	27	32	43	53	64	80	105	122	148
	Rated voltage (V) *3	Three-phase, 200 V/50 Hz, 200, 220, 230, 240 V/60 Hz (With AVR function)																
	Rated current (A) *4, *5	4.2	7.0	10.6	16.7	23.8 (22.5)	31.8 (29)	45 (42)	58 (55)	73 (68)	85 (80)	114 (107)	140 (130)	170 (156)	211 (198)	276 (270)	322 (320)	390 (384)
Overload capability		120% of rated current for 1 min																
Rated frequency		50, 60 Hz																
Input ratings	Main power supply	Three-phase, 200 to 240 V, 50/60 Hz											Three-phase, 200 to 220 V/50 Hz Three-phase, 200 to 230 V/60 Hz					
		Auxiliary control power input											Single-phase, 200 to 240 V, 50/60 Hz for the terminals					
	Phases, voltage, frequency	Single-phase, 200 to 240 V, 50/60 Hz for the terminals											Single-phase, 200 to 220 V/50 Hz Single-phase, 200 to 230 V/60 Hz					
		Auxiliary fan power input *6											None					
Voltage/frequency variations		Voltage: +10 to -15% (Voltage unbalance: 2% or less)*10, Frequency: +5 to -5%																
Rated current (A) *7	(with DCR)	3.2	6.1	8.9	15.0	21.1	28.8	42.2	57.6	71.0	84.4	114	138	167	203	282	334	410
	(without DCR)	5.3	9.5	13.2	22.2	31.5	42.7	60.7	80.1	97.0	112	151	185	225	270	—	—	—
Required power supply capacity (kVA) *8		1.2	2.2	3.1	5.3	7.4	10	15	20	25	30	40	48	58	71	98	116	142
Braking	Torque (%) *9	20											10 to 15					
	DC braking	Starting frequency: 0.0 to 60.0 Hz, Braking time: 0.0 to 30.0 s, Braking level: 0 to 60%																
DC reactor (DCR)		Option															Standard	
Applicable safety standards		UL508C, C22.2 No.14, EN50178:1997 (Applying)																
Enclosure (IEC60529)		IP20, UL open type											IP00, UL open type					
Cooling method		Natural cooling			Fan cooling													
Mass (kg)		3.1	3.2	3.3	3.4	3.4	5.8	6.0	6.9	9.5	9.7	11.5	23	33	34	41		

*1 Fuji 4-pole standard motor

*2 Rated capacity is calculated by assuming the output rated voltage as 220 V for three-phase 200 V series.

*3 Output voltage cannot exceed the power supply voltage.

*4 An excessively low setting of the carrier frequency may result in the higher motor temperature or tripping of the inverter by its overcurrent limiter setting. Lower the continuous load or maximum load instead. (When setting the carrier frequency (F26) to 1 kHz, reduce the load to 80% of its rating.)

*5 When an inverter is continuously running with the carrier frequency of 3 kHz or more in the ambient temperature of 40 °C or higher, manage its load current to be within the rated ones denoted in parentheses ().

*6 Use [R1, T1] terminals for driving AC cooling fans of an inverter powered by the DC link bus, such as by a high power factor PWM converter. (In ordinary operation, the terminals are not used.)

*7 Calculated under Fuji-specified conditions.

*8 Obtained when a DC reactor (DCR) is used.

*9 Average braking torque (Varies with the efficiency of the motor.)

*10 Voltage unbalance (%) = $\frac{\text{Max. voltage (V)} - \text{Min. voltage (V)}}{\text{Three-phase average voltage (V)}} \times 67$ (IEC61800-3 (5.2.3))

If this value is 2 to 3%, use an AC reactor (ACR).

Note: A box (□) in the above table replaces A, K, or E depending on the shipping destination.

8.1.2 Three-phase 400 V series

■ 0.75 to 55 kW

Item		Specifications														
Type (FRN__ _F1S-4 □)		0.75	1.5	2.2	3.7 (4.0)* ⁹	5.5	7.5	11	15	18.5	22	30	37	45	55	
Nominal applied motor (kW)		*1	0.75	1.5	2.2	3.7 (4.0)* ⁹	5.5	7.5	11	15	18.5	22	30	37	45	55
Output ratings	Rated capacity (kVA)	*2	1.9	2.8	4.1	6.8	9.5	12	17	22	28	33	44	54	64	80
	Rated voltage (V)	*3	Three-phase, 380, 400 V/50 Hz, 380, 400, 440, 460 V/60 Hz (with AVR function)													
	Rated current (A)	*4	2.5	3.7	5.5	9.0	12.5	16.5	23	30	37	44	59	72	85	105
	Overload capability	120% of rated current for 1 min														
	Rated frequency	50, 60 Hz														
Input ratings	Phases, voltage, frequency	Main power supply	Three-phase, 380 to 480 V, 50/60 Hz											Three-phase, 380 to 440 V/50 Hz Three-phase, 380 to 480 V/60 Hz		
		Auxiliary control power input	Single-phase, 380 to 480 V, 50/60 Hz											Single-phase, 380 to 440 V/50 Hz Single-phase, 380 to 480 V/60 Hz		
		Auxiliary fan power input	*5	None											*10	
	Voltage/frequency allowance		Voltage: +10 to -15% (Voltage unbalance: 2% or less)* ¹¹ , Frequency: +5 to -5%													
Braking	Rated current (A)	(with DCR)	1.6	3.0	4.5	7.5	10.6	14.4	21.1	28.8	35.5	42.2	57.0	68.5	83.2	102
		(without DCR)	*6	3.1	5.9	8.2	13.0	17.3	23.2	33.0	43.8	52.3	60.6	77.9	94.3	114
	Required power supply capacity (kVA)	*7	1.2	2.2	3.1	5.3	7.4	10	15	20	25	30	40	48	58	71
Torque (%)	*8	20										10 to 15				
	DC braking	Starting frequency: 0.0 to 60.0 Hz, Braking time: 0.0 to 30.0 s, Braking level: 0 to 60%														
DC reactor (DCR)		Option														
Applicable safety standards		UL508C, C22.2 No.14, EN50178:1997 (Applying)														
Enclosure (IEC60529)		IP20, UL open type										IP00, UL open type				
Cooling method		Natural cooling				Fan cooling										
Mass (kg)		3.1	3.2	3.3	3.4	3.4	5.8	6.0	6.9	9.4	9.9	11.5	23	24	33	

*1 Fuji 4-pole standard motor

*2 Rated capacity is calculated by assuming the output rated voltage as 440 V for three-phase 400 V series.

*3 Output voltage cannot exceed the power supply voltage.

*4 An excessively low setting of the carrier frequency may result in the higher motor temperature or tripping of the inverter by its overcurrent limiter setting. Lower the continuous load or maximum load instead. (When setting the carrier frequency (F26) to 1 kHz, reduce the load to 80% of its rating.)

*5 Use [R1, T1] terminals for driving AC cooling fans of an inverter powered by the DC link bus, such as by a high power factor PWM converter. (In ordinary operation, the terminals are not used.)

*6 Calculated under Fuji-specified conditions.

*7 Obtained when a DC reactor (DCR) is used.

*8 Average braking torque (Varies with the efficiency of the motor.)

*9 The nominal applied motor of FRN4.0F1S-4E to be shipped for EU is 4.0 kW.

*10 Single-phase, 380 to 440 V/50 Hz or Single-phase, 380 to 480 V/60 Hz

Max. voltage (V) - Min. voltage (V)

*11 Voltage unbalance (%) = $\frac{\text{Three-phase average voltage (V)} \times 67}{\text{Three-phase average voltage (V)}} \times 67$ (IEC61800-3 (5.2.3))

If this value is 2 to 3%, use an AC reactor (ACR).

Note: A box (□) in the above table replaces A, K, or E depending on the shipping destination.

■ 75 to 500 kW

Item		Specifications													
Type (FRN__ _F1S-4□)		75	90	110	132	160	200	220	280	315	355	400	450	500	
Nominal applied motor (kW)	*1	75	90	110	132	160	200	220	280	315	355	400	450	500	
Output ratings	Rated capacity (kVA)	*2	105	128	154	182	221	274	316	396	445	495	563	640	731
	Rated voltage (V)	*3	Three-phase, 380, 400 V/50 Hz, 380, 400, 440, 460 V/60 Hz (with AVR function)												
	Rated current (A)	*4	139	168	203	240	290	360	415	520	585	650	740	840	960
	Overload capability		120% of rated current for 1 min												
	Rated frequency		50, 60 Hz												
Input ratings	Phases, voltage, frequency	Main power supply	Three-phase, 380 to 440 V, 50 Hz or Three-phase, 380 to 480 V, 60 Hz												
		Auxiliary control power input	Single-phase, 380 to 480 V, 50/60 Hz												
		Auxiliary fan power input	Single-phase, 380 to 440 V/50 Hz Single-phase, 380 to 480 V/60 Hz												
	Voltage/frequency allowance		Voltage: +10 to -15% (Voltage unbalance: 2% or less)*9, Frequency: +5 to -5%												
Rated current (A)	*6	(with DCR)	138	164	201	238	286	357	390	500	559	628	705	789	881
		(without DCR)	—	—	—	—	—	—	—	—	—	—	—	—	—
Required power supply capacity (kVA)	*7	96	114	140	165	199	248	271	347	388	435	489	547	611	
Braking	Torque (%)	*8	10 to 15												
	DC braking		Starting frequency: 0.0 to 60.0 Hz, Braking time: 0.0 to 30.0 s, Braking level: 0 to 60%												
DC reactor (DCR)		Standard													
Applicable safety standards		UL508C, C22.2 No.14, EN50178:1997 (Applying)													
Enclosure (IEC60529)		IP00, UL open type													
Cooling method		Fan cooling													
Mass (kg)		34	42	45	63	67	96	98							

*1 Fuji 4-pole standard motor

*2 Rated capacity is calculated by assuming the output rated voltage as 440 V for three-phase 400 V series.

*3 Output voltage cannot exceed the power supply voltage.

*4 An excessively low setting of the carrier frequency may result in the higher motor temperature or tripping of the inverter by its overcurrent limiter setting. Lower the continuous load or maximum load instead. (When setting the carrier frequency (F26) to 1 kHz, reduce the load to 80% of its rating.)

*5 Use [R1, T1] terminals for driving AC cooling fans of an inverter powered by the DC link bus, such as by a high power factor PWM converter. (In ordinary operation, the terminals are not used.)

*6 Calculated under Fuji-specified conditions.

*7 Obtained when a DC reactor (DCR) is used.

*8 Average braking torque (Varies with the efficiency of the motor.)

*9 Voltage unbalance (%) = $\frac{\text{Max. voltage (V)} - \text{Min. voltage (V)}}{\text{Three-phase average voltage (V)}} \times 67$ (IEC61800-3 (5.2.3))

If this value is 2 to 3%, use an AC reactor (ACR).

Note: A box (□) in the above table replaces A, K, or E depending on the shipping destination.

8.2 Specifications of Keypad Related

8.2.1 General specifications of keypad

Table 8.1 General Specifications

Items	Specification	Remarks
Protective structure	Front side: IP40, Back (mounting) side: IP20	
Site to be installed	In door	
Ambient temperature	-10 to 50°C	
Ambient humidity	5 to 95% RH, no condensation allowed	
Ambient air	No corrosive gas, no inflammable gas, no dust, and no direct sunlight allowed	
Altitude	1000m or less	(Note)
Air pressure	86 to 106 kPa	
Vibration	3 mm (maximum amplitude): 9.8 m/s ² : 2 m/s ² : 1 m/s ² : Within 2 to 9 Hz Within 9 to 20 Hz Within 20 to 55 Hz Within 55 to 200 Hz	
Storage ambient temperature	-25 to 70°C	
Storage ambient humidity	5 to 95% RH (no condensation allowed)	
External dimension	Refer to Section 8.5.3 "Keypad"	
Mass	55 grams	

(Note) When using an inverter in a place of an altitude within 1000 m to 3000 m, you need to lower the output current of the inverter. For details, refer to Chapter 2, Section 2.1 "Operating Environment."

8.2.2 Communications specifications of keypad

Table 8.2 Hardware specifications

Items	Specification	Remarks
No. of linkable unit	One-to-one connection with an inverter	For a remote site operation.
Link cable	US ANSI TIA/EIA-568A category 5 compliant straight type cable (10BASE-T/100BASE-TX straight type)	Extension cable for the remote site operation (CB-5S, CB-3S, CB-1S and etc.)
Maximum cable length	20m	
Connector	Standard RJ-45 connector/jack	Refer to Table 8.3

Table 8.3 Pin Assignment of RJ-45 Connector









Pin number	Signal	Description	Remarks
1 and 8	Vcc	Power supply lines for keypad	5 VDC
2 and 7	GND	Grounding lines	0 V to the ground
3 and 6	NC	Reserved	
4	DX-	RS485 communications data line (-)	
5	DX+	RS485 communications data line (+)	

8.2.3 Data transmission specifications

Table 8.4 Data Transmission Specification

Items	Specification	Remarks
Station address	No need to specify.	To use any keypad, no setup is needed for RS485 communications related function codes y01 to y10 because their data is ignored.
Communications protocol	Modbus-RTU	
Synchronization system	Asynchronous start-stop system	
Communications system	Half-duplex	
Transmission speed	19,200 bps	
Parity	Even	
Stop bits	1 bit	
Error checking	CRC-16	

8.3 Common Specifications

	Item	Explanation	Remarks	
Output frequency	Setting range	Maximum frequency	25 to 120 Hz	
		Base frequency	25 to 120 Hz	
		Starting frequency	0.1 to 60.0 Hz	
		Carrier frequency	<ul style="list-style-type: none"> • 0.75 to 15 kHz (200 V/400 V: 0.75 to 22 kW) • 0.75 to 10 kHz (200 V/400 V: 30 to 75 kW) • 0.75 to 6 kHz (200 V/400 V: 90 to 500 kW) 	The carrier frequency may drop automatically according to the ambient temperature or output current to protect the inverter. This protective operation can be canceled by function code H98.
	Accuracy (Stability)	<ul style="list-style-type: none"> • Analog setting: $\pm 0.2\%$ of maximum frequency (at $25\pm 10^{\circ}\text{C}$) • Keypad setting: $\pm 0.01\%$ of maximum frequency (at -10 to $+50^{\circ}\text{C}$) 		
	Setting resolution	<ul style="list-style-type: none"> • Analog setting: 1/1000 of maximum frequency (ex. 0.06 Hz at 60 Hz, 0.12 Hz at 120 Hz) • Keypad setting: 0.01 Hz (99.99 Hz or less), 0.1 Hz (100.0 Hz or more) • Link setting: Selectable from 2 types- <ul style="list-style-type: none"> • 1/20000 of maximum frequency (ex. 0.003 Hz at 60 Hz, 0.006 Hz at 120 Hz) • 0.01 Hz (fixed) 	Setting with  /  key.	
Control	Control method	V/f control		
	Voltage/freq. characteristic (Non-linear V/f setting)	Possible to set output voltage at base frequency and at maximum output frequency (common spec.). AVR control can be turned ON or OFF.	Three-phase 200 V: 80 to 240 V Three-phase 400 V: 160 to 500 V	
		----- 1 point (Arbitrary voltage and frequency can be set.)	Three-phase 200 V: 0 to 240 V/0 to 120 Hz Three-phase 400 V: 0 to 500 V/0 to 120 Hz	
	Torque boost (Load selection)	Torque boost can be set with the function code F09.	Set when 0, 1, 3, or 4 is selected at F37.	
		Select application load type with the function code F37. 0: Variable torque load 1: Variable torque load (for high starting torque) 2: Auto-torque boost 3: Auto-energy-saving operation (variable torque load in acceleration/deceleration) 4: Auto-energy-saving operation (variable torque load (for high starting torque) for acceleration/deceleration) 5: Auto-energy-saving operation (auto-torque boost in acceleration/deceleration)		
	Starting torque	50% or over		
	Start/stop	Keypad operation	Start (FWD/REV) and stop with  and  keys	Keypad (standard)
			Start and stop with  or  , and  keys	Multifunction keypad (option)
		External signals (7 digital inputs): Forward (reverse) rotation, stop command (capable of 3-wire operation), second operation command, coast-to-stop command, external alarm, alarm reset, etc.		
		Link operation: Operation through RS485 communication and Field Bus communication (option) Operation command switch: Remote/local switch, link switch, second operation command switch		
Frequency command source	Keypad operation: Can be set with  /  key.			
	External potentiometer (1 to 5 k Ω , 1/2 W): Prepared by users		Connected to analog input terminals [13], [12], [11].	
	Analog input	Can be set with external voltage/current input. 0 to 10 VDC (0 to 5 VDC) /0 to 100% (terminal [12], [V2]) 4 to 20mA DC/0 to 100% (terminal [C1])	E.g.: 0 to 5 VDC/1 to 5 VDC is applicable with bias/gain for analog input.	
		Multistep frequency: Selectable from 8 steps (step 0 to 7)		
	UP/DOWN operation: The frequency rises or lowers while the digital input signal is turned on.			
	Link operation: Can be set with RS485 communications and field bus communications (option).			
	Frequency setting change: Two types of frequency settings can be switched with an external signal (digital input). Changeover between remote and local (keypad operation) or frequency setup through communication is also possible.			
	Auxiliary frequency setting: Inputs at terminal [12], [C1] or [V2] can be added to the main setting as auxiliary frequency settings.			
	Inverse operation: The digital input signal and function code setting sets or switches between the normal and inverse operations. • 10 to 0 VDC/0 to 100% (Terminal [12], [V2]) • 20 to 4 mA DC/0 to 100% (Terminal [C1])			
	Acceleration/ deceleration time	0.00 to 3600 s • Acceleration and deceleration pattern can be selected from 4 types: Linear, S-curve (weak), S-curve (strong), Curve (constant output max. capacity). • Shutoff of the operation command coasts the motor to decelerate and stop.		

	Item	Explanation	Remarks
Control	Frequency limiter	High and low limiters can be set (setting range: 0 to 120 Hz)	Selection can be made between continuation of operation and stopping at frequencies equal to or smaller than the lower limit.
	Bias frequency	Bias of frequency and PID commands can be set in the range between 0 and $\pm 100\%$.	
	Gain for frequency setting	The analog input gain can be set in the range from 0 to 200%.	Voltage signals (terminal [12], [V2]) and current signal (terminal [C1]) can be set independently.
	Jump frequency setting	3 operation points and their common jump hysteresis width (0 to 30 Hz) can be set.	
	Restart after momentary power failure	<ul style="list-style-type: none"> The inverter restarts upon recovery from power failure without stopping the motor. In the "operation continuation mode," recovery of the power supply is waited for while the output frequency slightly drops. Selection can be made among starting at 0 Hz, starting at the frequency immediately before the momentary power failure, and starting at the frequency specified in the starting mode after power recovery. 	
	Current limit	Keeps the current under the preset value during operation.	
	Line/inverter switching	<ul style="list-style-type: none"> Line/inverter switching (starting at line frequency) can be made with a digital input signal (SW50, SW60). A built-in line/inverter switching sequence performs sequence control with a digital input signal (ISW50, ISW60) to output a signal (SW88, SW52-1, SW52-2) for controlling an external magnetic contactor (MC). As a built-in sequence, two types can be selected, including the one switching automatically to the line upon an inverter alarm. 	
	PID control	<p>Capable of PID regulator control for process</p> <p>Process commands</p> <ul style="list-style-type: none"> Key operation (UP and DOWN keys): 0 to 100% Analog input (terminal [12], [V2]): 0 to 10 VDC/0 to 100% Analog input (terminal [C1]): 4 to 20 mA DC/0 to 100% UP/DOWN (digital input): 0 to 100% Communication (RS485, Bus option): 0 to 20,000/0 to 100% <p>Feedback value</p> <ul style="list-style-type: none"> Analog input (terminal [12], [V2]): 0 to 10 VDC/0 to 100% Analog input (terminal [C1]): 4 to 20 mA DC/0 to 100% <p>Accessory functions</p> <ul style="list-style-type: none"> Alarm output (absolute value alarm, deviation alarm) • Normal operation/inverse operation Sleep function • Anti reset windup function PID output limiter • Integration reset/hold 	
	Auto search for idling motor's speed	Starting at the preset frequency, the inverter automatically searches the idling motor speed to be harmonized and starts to drive it without stopping it.	
	Automatic deceleration	Upon a DC link bus voltage exceeding the overvoltage limit level during deceleration, the deceleration time automatically extends to avoid an \overline{UV} trip.	
	Deceleration characteristic	The motor loss increases during deceleration to reduce the load energy regenerating at the inverter to avoid an \overline{UV} trip upon mode selection.	
	Automatic energy-saving operation	The output voltage is controlled to minimize the total sum of the motor loss and inverter loss at a constant speed.	
	Overload protection control	The output frequency is automatically reduced to suppress the overload protection trip of the inverter caused by an increase in the ambient temperature or motor load, or by other operating conditions.	
Auto-tuning	The motor parameters are automatically tuned.		
Cooling fan ON/OFF control	Detects inverter internal temperature and stops cooling fan when the temperature is low.	An external output can be issued in a transistor or relay output signal.	
Pump control	<p>An inverter controls multiple driving pumps at a time combining with driving sources of the inverter and commercial power. The inverter's integrated PID controller controls them in the flowrate, pressure and so on. The inverter controls each member of pump control sequences issuing the power source switching signal between the inverter output and commercial power. Two control modes are available. One is a fixed motor-driving mode where the inverter exclusively controls the single pump. Another is a cyclic motor-driving mode where the inverter cyclically controls a member of pumps.</p> <ul style="list-style-type: none"> Fixed motor-driving mode: Pumps under control = one inverter driven + four commercial power driven Cyclic motor-driving mode: Pumps under control = three inverter/commercial power driven (In this mode, a relay output card option (OPC-F1S-RY) is required.) <p>Furthermore, this control features a constantly periodic switching function, an average time drive-switching function, a cumulative pump run time monitor, a cumulative relay activating times monitor and so on.</p>		
Indication	Running/stopping	<ul style="list-style-type: none"> Speed monitor, output current (A), output voltage (V), torque calculation value, input power (kW), PID reference value, PID feedback value, PID output, load factor, motor output Select the speed monitor to be displayed from the following. Output frequency (Hz), motor speed (r/min), load shaft speed (r/min), % indication 	
	Lifetime early warning	Shows the lifetime early warnings of the electrolytic capacitors on the printed circuit boards, the DC link bus capacitor, and the cooling fan.	An external output can be issued in a transistor or relay output signal.
	Cumulative run time	Shows the cumulative running hours of the motor and inverter, and the input watt-hour.	

Item	Explanation	Remarks	
Indication	Displays the cause of trip by codes. <ul style="list-style-type: none"> • <i>OC 1</i> (Overcurrent during acceleration) • <i>OC 3</i> (Overcurrent during running at constant speed) • <i>L 1n</i> (Input phase loss) • <i>OPL</i> (Output phase loss) • <i>OU 2</i> (Overvoltage during deceleration) • <i>OH 1</i> (Overheating of the heat sink) • <i>OH 3</i> (Inverter overheat) • <i>OL 1</i> (Motor overload) • <i>FUS</i> (Blown fuse) • <i>Er 1</i> (Memory error) • <i>Er 3</i> (CPU error) • <i>Er 5</i> (Option error) • <i>Er 7</i> (Tuning error) • <i>Er F</i> (Data save error due to undervoltage) • <i>Er H</i> (LSI error) 	<ul style="list-style-type: none"> • <i>OC 2</i> (Overcurrent during deceleration) • <i>EF</i> (Grounding fault) • <i>LU</i> (Undervoltage) • <i>OU 1</i> (Overvoltage during acceleration) • <i>OU 3</i> (Overvoltage during running at constant speed) • <i>OH 4</i> (External alarm) • <i>OH 4</i> (Motor protection (PTC thermistor)) • <i>OL U</i> (Inverter overload) • <i>PbF</i> (Charging circuit fault) • <i>Er 2</i> (Keypad communication error) • <i>Er 4</i> (Optional communication error) • <i>Er 5</i> (Operation action error) • <i>Er 8</i> (RS485 communication error) • <i>Er P</i> (RS485 communication error (option)) 	
	Trip history	Saves and displays the last 4 trip error codes and their detailed description.	
Protection	Refer to Section 8.6 "Protective Functions."		
Environment	Refer to Chapter 1, Section 1.4 "Storage Environment" and Chapter 2, Section 2.1 "Operating Environment"		

8.4 Terminal Specifications

8.4.1 Terminal functions

For details about the main and control circuit terminals, refer to Chapter 2, Section 2.3.6 and Section 2.3.7 (Table 2.11), respectively.

8.4.2 Running the inverter with keypad

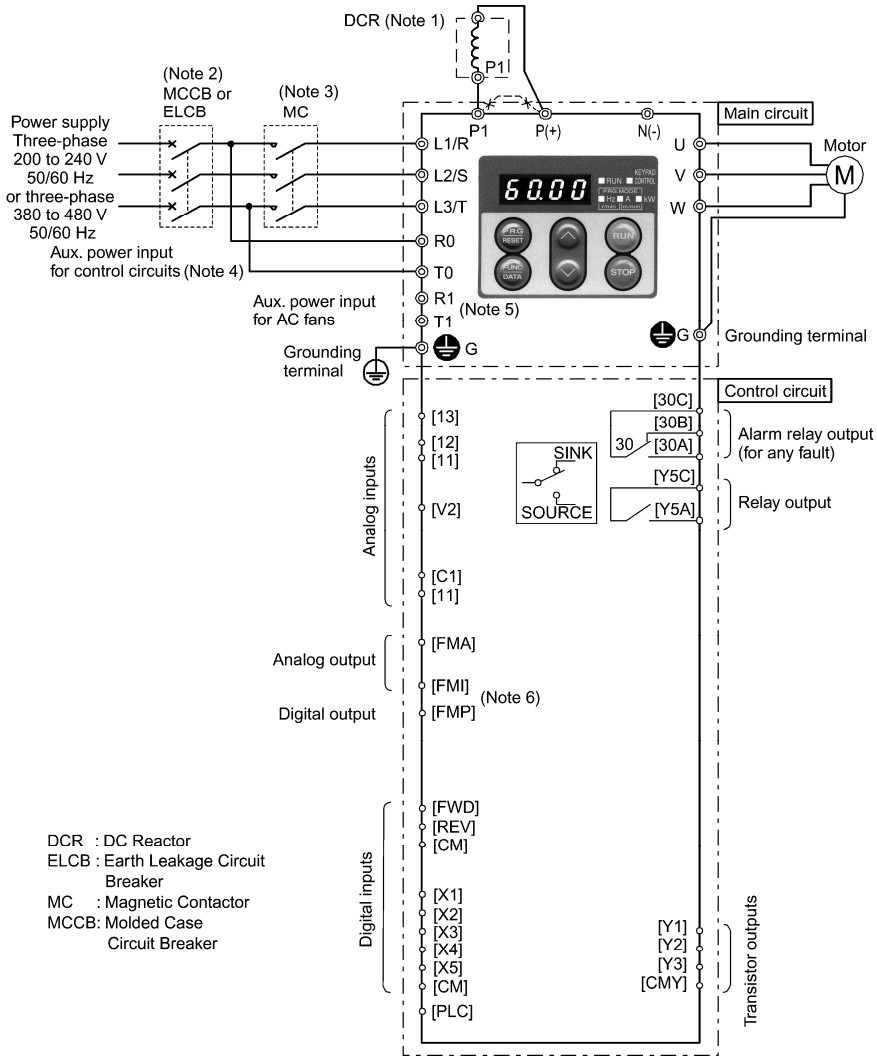

(Note 1) When connecting a DC reactor (DCR), first remove the short bar between terminals [P1] and [P+]. A DCR is optional for inverters below 75 kW but standard for inverters of 75 kW or above. For inverters of 75 kW or above, be sure to connect a DCR.

(Note 2) To protect wiring, insert a molded case circuit breaker (MCCB) or an earth leakage circuit breaker (ELCB) (with overcurrent protection) of the type recommended for the inverter between the commercial power supply and the inverter. Do not use a circuit breaker with a capacity exceeding the recommended capacity.

(Note 3) In addition to an MCCB or ELCB, insert, if necessary, a magnetic contactor (MC) of the type recommended for the inverter to cut off the commercial power supply to the inverter. Furthermore, if the coil of the MC or solenoid comes into close contact with the inverter, install a surge absorber in parallel.

(Note 4) To put the inverter on standby by making the control circuit only active with the main circuit power supply being opened, connect this pair of wires to terminals [R0] and [T0]. Without connecting this pair of wires to these terminals, you can still run the inverter as long as the main wires of the commercial power supply to the main circuit are properly connected.

(Note 5) Normally no need to be connected. Use these terminals when the inverter is equipped with a high power factor PWM converter with a regenerative facility.

(Note 6) The inverter has either [FMP] or [FMI] depending on the type of the control printed circuit board (control PCB).

8.4.3 Running the inverter by terminal commands

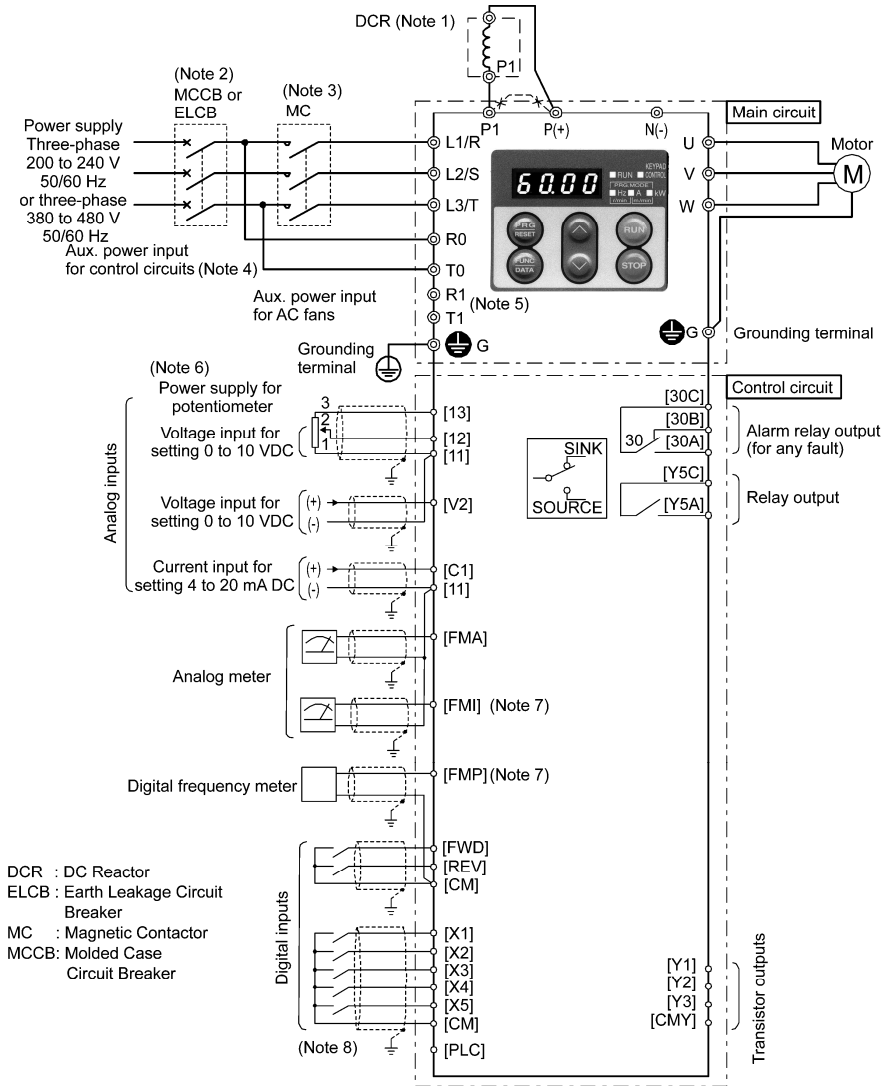

- (Note 1) When connecting a DC reactor (DCR), first remove the short bar between terminals [P1] and [P+]. A DCR is optional for inverters below 75 kW but standard for inverters of 75 kW or above. For inverters of 75 kW or above, be sure to connect a DCR.
- (Note 2) To protect wiring, insert a molded case circuit breaker (MCCB) or an earth leakage circuit breaker (ELCB) (with overcurrent protection) of the type recommended for the inverter between the commercial power supply and the inverter. Do not use a circuit breaker with a capacity exceeding the recommended capacity.
- (Note 3) In addition to an MCCB or ELCB, insert, if necessary, a magnetic contactor (MC) of the type recommended for the inverter to cut off the commercial power supply to the inverter. Furthermore, if the coil of the MC or solenoid comes into close contact with the inverter, install a surge absorber in parallel.
- (Note 4) To put the inverter on standby by making the control circuit only active with the main circuit power supply being opened, connect this pair of wires to terminals [R0] and [T0]. Without connecting this pair of wires to these terminals, you can still run the inverter as long as the main wires of the commercial power supply to the main circuit are properly connected.

- (Note 5) Normally no need to be connected. Use these terminals when the inverter is equipped with a high power factor PWM converter with a regenerative facility.
- (Note 6) You can select the frequency command source either electronically by supplying a DC voltage signal (within the range of 0 to 10 V, 0 to 5 V, or 1 to 5 V) between terminals [12] and [11], or manually by connecting a frequency command potentiometer to terminals [13], [12], and [11].
- (Note 7) The inverter has either [FMP] or [FMI] depending on the type of the control printed circuit board (control PCB).
- (Note 8) For the wiring of the control circuit, use shielded or twisted wires. When using shielded wires, connect the shields to earth. To prevent malfunction due to noise, keep the control circuit wires as far away as possible from the main circuit wires (recommended distance: 10 cm or longer), and never put them in the same wire duct. Where a control circuit wire needs to cross a main circuit wire, route them so that they meet at right angles.

8.5 External Dimensions

8.5.1 Standard models

Unit: mm

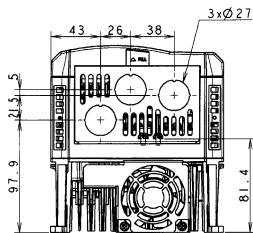
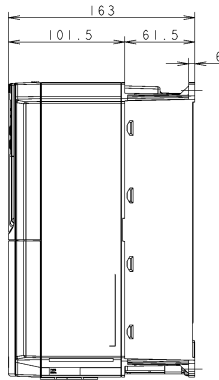
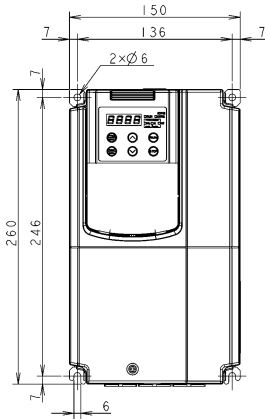

Power supply voltage	Type
Three-phase 200 V	FRN0.75F1S-2□
	FRN1.5F1S-2□
	FRN2.2F1S-2□
	FRN3.7F1S-2□
	FRN5.5F1S-2□
Three-phase 400 V	FRN0.75F1S-4□
	FRN1.5F1S-4□
	FRN2.2F1S-4□
	FRN3.7F1S-4□
	FRN4.0F1S-4E *
	FRN5.5F1S-4□

* The applicable motor rating of FRN4.0F1S-4E to be shipped for EU is 4.0 kW.

Note: A box (□) in the above table replaces A, K, or E depending on the shipping destination.

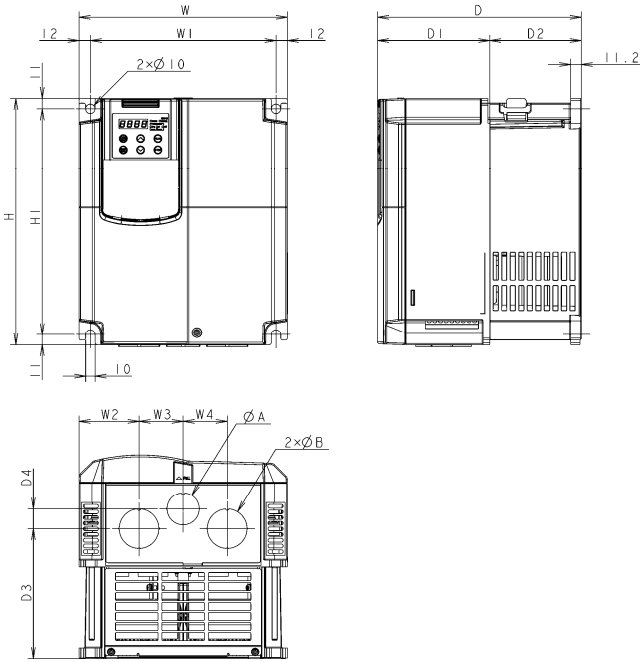

Power supply voltage	Type	Dimensions (mm)													
		W	W1	W2	W3	W4	H	H1	D	D1	D2	D3	D4	φA	φB
Three-phase 200 V	FRN7.5F1S-2□	220	196	63.5	46.5	46.5	260	238	215	118.5	96.5	141.7	16	28	35
	FRN11F1S-2□											136.7	21	34	42
	FRN15F1S-2□	250	226	67	58	58	400	378		85	130	166.2	2	35	44
	FRN18.5F1S-2□			-	-	-	-	-		-	-	-	-	-	
	FRN22F1S-2□			-	-	-	-	-		-	-	-	-	-	-
FRN30F1S-2□	-	-	-	-	-	-	-	-	-	-	-	-	-		
Three-phase 400 V	FRN7.5F1S-4□	220	196	63.5	46.5	46.5	260	238	215	118.5	96.5	141.7	16	28	35
	FRN11F1S-4□											136.7	21	34	42
	FRN15F1S-4□	250	226	67	58	58	400	378		85	130	166.2	2	35	44
	FRN18.5F1S-4□			-	-	-	-	-		-	-	-	-	-	
	FRN22F1S-4□			-	-	-	-	-		-	-	-	-	-	-
FRN30F1S-4□	-	-	-	-	-	-	-	-	-	-	-	-	-		

Note: A box (□) in the above table replaces A, K, or E depending on the shipping destination.

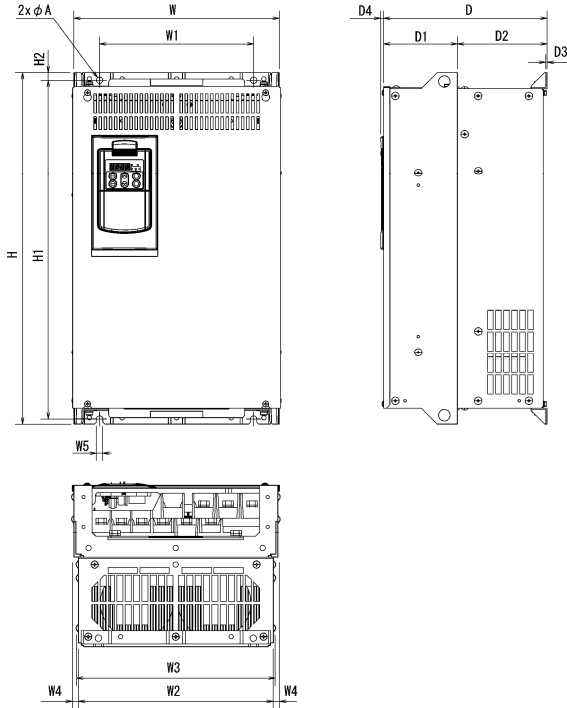

Power supply voltage	Type	Dimensions (mm)														
		W	W1	W2	W3	W4	W5	H	H1	H2	D	D1	D2	D3	D4	φA
Three-phase 200 V	FRN37F1S-2□	320	240	304	310.2	8	10	550	530	12	255	115	140	4	4.5	10
	FRN45F1S-2□	355	275	339	345.2			615	595		270		155			
	FRN55F1S-2□					740	720	300	145							
	FRN75F1S-2□					740	720									
Three-phase 400 V	FRN37F1S-4□	320	240	304	310.2	8	10	550	530	12	255	115	140	4	4.5	10
	FRN45F1S-4□	355	275	339	345.2			615	595		270		155			
	FRN55F1S-4□					740	720	315	135							
	FRN75F1S-4□					740	720									
	FRN90F1S-4□	530	430	503	509.2	13.5	15	710	15.5	360	180	180	6	15		
	FRN110F1S-4□							710		360	180	180				
	FRN132F1S-4□							1000	970							
	FRN160F1S-4□	1000	970	15.5	360	180	180	6	15							
	FRN200F1S-4□															
	FRN220F1S-4□															

Note: A box (□) in the above table replaces A, K, or E depending on the shipping destination.

8.5.2 DC reactor

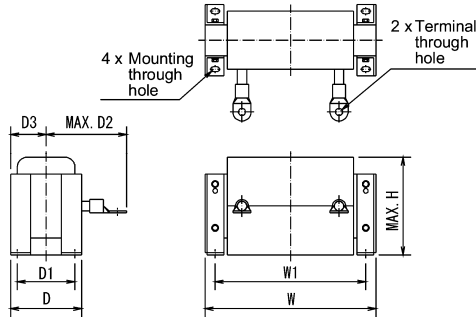

Power supply voltage	Inverter type	Reactor	Dimension (mm)									Mass
			W	W1	D	D1	D2	D3	H	Mounting through hole for:	Terminal through hole for:	
Three-phase 200 V	FRN37F1S-2□	DCR2-37C	210 ± 10	185	101 ± 2	81	125	50.5 ± 1	125	M6	M10	7.4
	FRN45F1S-2□	DCR2-45C	210 ± 10	185	106 ± 2	86	135	53 ± 1	125	M6	M12	8.4
	FRN55F1S-2□	DCR2-55C	255 ± 10	225	96 ± 2	76	140	48 ± 1	145	M6	M12	10.2
	FRN75F1S-2□	DCR2-75C	255 ± 10	225	106 ± 2	86	145	53 ± 1	145	M6	M12	11.4
Three-phase 400 V	FRN37F1S-4□	DCR4-37C	210 ± 10	185	101 ± 2	81	105	50.5 ± 1	125	M6	M8	7.4
	FRN45F1S-4□	DCR4-45C	210 ± 10	185	106 ± 2	86	120	53 ± 1	125	M6	M8	8.4
	FRN55F1S-4□	DCR4-55C	255 ± 10	225	96 ± 2	76	120	48 ± 1	145	M6	M10	10.3
	FRN75F1S-4□	DCR4-75C	255 ± 10	225	106 ± 2	86	125	53 ± 1	145	M6	M10	12.4
	FRN90F1S-4□	DCR4-90C	255 ± 10	225	116 ± 2	96	140	58 ± 1	145	M6	M12	14.7
	FRN110F1S-4□	DCR4-110C	300 ± 10	265	116 ± 2	90	175	58 ± 1	155	M8	M12	18.4
	FRN132F1S-4□	DCR4-132C	300 ± 10	265	126 ± 4	100	180	63 ± 2	160	M8	M12	22.0
	FRN160F1S-4□	DCR4-160C	350 ± 10	310	131 ± 4	103	180	65.5 ± 2	190	M10	M12	25.5
	FRN200F1S-4□	DCR4-200C	350 ± 10	310	141 ± 4	113	185	70.5 ± 2	190	M10	M12	29.5
FRN220F1S-4□	DCR4-220C	350 ± 10	310	146 ± 4	118	200	73 ± 2	190	M10	M12	32.5	

Note 1) For inverters of 75 kW or above types (FRN75F1S-2□, FRN75F1S-4□ or above), a DC reactor is attached as standard.

2) A box (□) in the above table replaces A, K, or E depending on the shipping destination.

8.5.3 Keypad

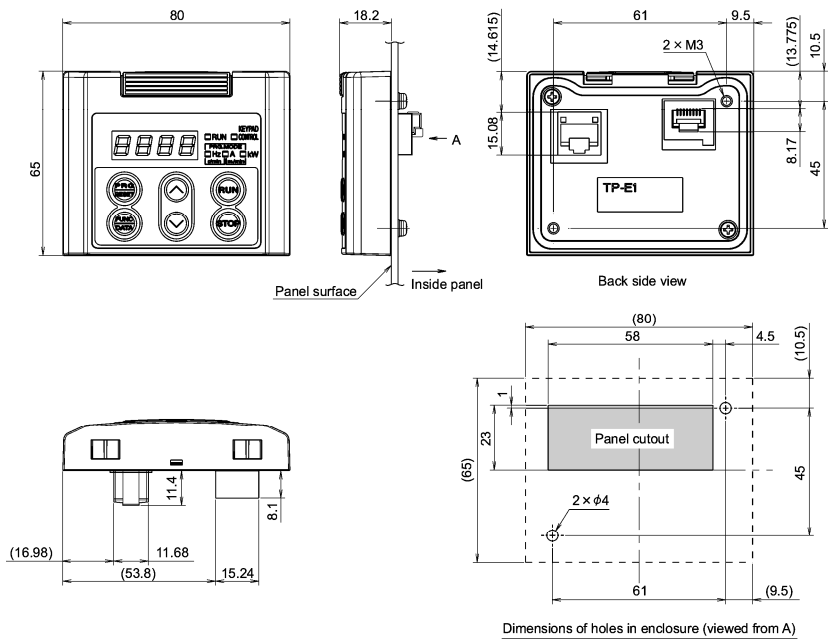

Unit : mm



8.6 Protective Functions

Name	Description	LED monitor displays	Alarm output [30A/B/C]
Overcurrent protection	Stops the inverter output to protect the inverter from an overcurrent resulting from overload.	OC1	Yes
Short-circuit protection	Stops the inverter output to protect the inverter from overcurrent due to a short-circuiting in the output circuit.	OC2	
		OC3	
Ground fault protection	Stops the inverter output to protect the inverter from overcurrent due to a ground fault in the output circuit. This protection is effective only during startup of the inverter. If you turn ON the inverter without removing the ground fault, this protection may not work. (Applicable to inverters of 75 kW or below (3-phase 200 V) or 220 kW or below (3-phase 400 V))	GF	Yes
	Upon detection of zero-phase current in the output power, this function stops the inverter output to protect the inverter from overcurrent due to a ground fault in the output circuit. (Applicable to inverters of 90 kW or above (3-phase 200 V) or 280 kW or above (3-phase 400 V))	EF	
Overvoltage protection	The inverter stops the inverter output upon detection of an overvoltage condition (400 VDC for 3-phase 200V, 800 VDC for 3-phase 400V series) in the DC link bus. This protection is not assured if extremely large AC line voltage is applied inadvertently.	OU1	Yes
		OU2	
		OU3	
Undervoltage protection	Stops the inverter output when the DC link bus voltage drops below the undervoltage level (200 VDC for 3-phase 200V, 400 VDC for 3-phase 400 V series). However, if data "3, 4, or 5" is selected for F14, no alarm is output even if the DC link bus voltage drops.	LU	Yes*1
Input phase loss protection	Detects input phase loss, stopping the inverter output. This function prevents the inverter from undergoing heavy stress that may be caused by input phase loss or inter-phase voltage unbalance and may damage the inverter. If connected load is light or a DC reactor is connected to the inverter, this function will not detect input phase loss if any.	LI	Yes
Output phase loss protection	Detects breaks in inverter output wiring at the start of running and during running, stopping the inverter output.	OP	Yes
Overheat protection	- Stops the inverter output upon detecting excess heat sink temperature in case of cooling fan failure or overload. - Detects a failure of the internal air circulation DC fan and alarm-stops the inverter (For models of 45 kW or above in 200 V series, 55 kW or above in 400 V series)	OH1	Yes
	Stops the inverter output upon detecting an excessively high ambient temperature inside the inverter caused by a failure or an overload condition of the cooling fan.	OH3	Yes
Overload protection	Stops the inverter output if the Insulated Gate Bipolar Transistor (IGBT) internal temperature calculated from the output current and temperature of inside the inverter is over the preset value.	OL	Yes
External alarm input	Places the inverter in alarm-stop state upon receiving digital input signal (THR).	OH2	Yes

*1 This alarm on [30A/B/C] should be ignored depending upon the function code setting.

Name	Description		LED monitor displays	Alarm output [30A/B/C]
Blown fuse	Upon detection of a fuse blown in the inverter's main circuit, this function stops the inverter output. (Applicable to 90 kW or above (for both 3-phase 200 V and 3-phase 400 V))		<i>FUS</i>	Yes
Abnormal condition in charger circuit	Upon detection of an abnormal condition in the charger circuit inside the inverter, this function stops the inverter output. (Applicable to 45 kW or above (3-phase 200 V) or 55 kW or above (3-phase 400 V))		<i>ABF</i>	Yes
Motor protection	Electronic thermal overload	In the following cases, the inverter stops running the motor to protect the motor in accordance with the electronic thermal overload protection setting. - Protects general-purpose motors over the entire frequency range (F10 = 1.) - Protects inverter motors over the entire frequency range (F0 = 2.) * The operation level and thermal time constant can be set by F11 and F12.	<i>OL 1</i>	Yes
	PTC thermistor	A PTC thermistor input stops the inverter output for motor protection. Connect a PTC thermistor between terminals [V2] and [11] and set the function codes and slide switch on the control PCB accordingly.	<i>TH</i>	Yes
	Overload early warning	Outputs a preliminary alarm at a preset level before the motor is stopped by the electronic thermal overload protection for the motor.	—	—
Stall prevention	Operates when instantaneous overcurrent limiting is active. - Instantaneous overcurrent limiting: Operates if the inverter's output current exceeds the instantaneous overcurrent limit level, avoiding tripping of the inverter (during constant speed operation or during acceleration).		—	—
Alarm relay output (for any fault)	- The inverter outputs a relay contact signal when the inverter issues an alarm and stops the inverter output. < Alarm reset > The alarm stop state is reset by pressing the  key or by the digital input signal (RST). < Saving the alarm history and detailed data > The information on the previous 4 alarms can be saved and displayed.		—	Yes
Memory error detection	The inverter checks memory data after power-on and when the data is written. If a memory error is detected, the inverter stops.		<i>Er 1</i>	Yes
Keypad communications error detection	The inverter stops by detecting a communications error between the inverter and the keypad during operation using the standard keypad or the multi-function keypad (optional).		<i>Er 2</i>	Yes
CPU error detection	If the inverter detects a CPU error or LSI error caused by noise or some other factors, this function stops the inverter		<i>Er 3</i>	Yes
Option communications error detection	Upon detection of an error in the communication between the inverter and an optional card, stops the inverter output.		<i>Er 4</i>	—
Option error detection	When an option card has detected an error, this function stops the inverter output.		<i>Er 5</i>	—
Operation error detection	STOP key priority	Pressing the  key on the keypad forces the inverter to decelerate and stop the motor even if the inverter is running by any run command given via the terminals or communications link. After the motor stops, the inverter issues alarm <i>Er 5</i> .	<i>Er 5</i>	Yes

"—": Not applicable.

Name	Description		LED monitor displays	Alarm output [30A/B/C]
Operation error detection	Start check function	The inverter prohibits any run operations and displays $E-5$ on the 7-segment LED monitor if any run command is present when: <ul style="list-style-type: none"> - Powering up - An alarm is released (the  key is turned ON or an alarm reset (RST) is input.) - "Enable communications link (LE)" has been activated and the run command is active in the linked source. 	$E-5$	Yes
Tuning error detection	During tuning of motor parameters, the tuning has failed or has aborted, or an abnormal condition has been detected in the tuning result, the inverter stops its output.		$E-7$	Yes
RS485 communications error detection	When the inverter is connected to a communications network via the RS485 port designed for the keypad, detecting a communications error stops the inverter output and displays an error code $E-B$.		$E-B$	Yes
Data save error during undervoltage	If the data could not be saved during activation of the undervoltage protection function, the inverter displays the alarm code.		$E-F$	Yes
RS485 communications error detection (optional)	When the inverter is connected to a communications network via an optional RS485 communications card, detecting a communications error stops the inverter output and displays an error code $E-P$.		$E-P$	Yes
LSI error detection (Power PCB)	When an error occurred in the LSI on the power printed circuit board (power PCB), this function stops the inverter. (Applicable to: 200 V series 45 kW or above, and 400 V series 55 kW or above)		$E-H$	Yes
Retry	When the inverter has stopped because of a trip, this function allows the inverter to automatically reset itself and restart. (You can specify the number of retries and the latency between stop and reset.)		—	—
Surge protection	Protects the inverter against a surge voltage which might appear between one of the power lines for the main circuit and the ground.		—	—
Command loss detected	Upon detecting a loss of a frequency command (because of a broken wire, etc.), this function issues an alarm and continues the inverter operation at the preset reference frequency (specified as a ratio to the frequency just before the detection).		—	—
Protection against momentary power failure	Upon detecting a momentary power failure lasting more than 15 ms, this function stops the inverter output. If restart after momentary power failure is selected, this function invokes a restart process when power has been restored within a predetermined period.		—	—
Overload prevention control	In the event of overheating of the heat sink or an overload condition (alarm code: $OL1$ or $OL2$), the output frequency of the inverter is reduced to keep the inverter from tripping.		—	—

"—": Not applicable.

Chapter 9 LIST OF PERIPHERAL EQUIPMENT AND OPTIONS

The table below lists the main peripheral equipment and options that are connected to the FRENIC-Eco. Use them in accordance with your system requirements.

 For details, refer to the FRENIC-Eco User's Manual (MEH456), Chapter 6 "SELECTING PERIPHERAL EQUIPMENT."

	Name of peripheral equipment	Function and application																																																																																																																																																						
Main peripheral equipment	Molded case circuit breaker (MCCB)	MCCBs are designed to protect the power circuits between the power control board and inverter's main terminals (L1/R, L2/S and L3/T) from overload or short-circuit which in turn prevents secondary disasters caused by the inverter malfunctioning.																																																																																																																																																						
	Residual-current-operated protective device (RCD) /Earth leakage circuit breaker (ELCB)*	RCDs/ELCBs function in the same way as MCCBs. Use the MCCBs and RCDs/ELCBs that satisfy the recommended rated current listed below.																																																																																																																																																						
	* with overcurrent protection	<table border="1"> <thead> <tr> <th data-bbox="331 400 423 488" rowspan="2">Input power source (3-phase)</th> <th data-bbox="423 400 557 488" rowspan="2">Applicable motor rating (kW)</th> <th data-bbox="557 400 732 488" rowspan="2">Inverter type</th> <th colspan="2" data-bbox="732 400 1039 456">Rated current of MCCB and ELCB (A)</th> </tr> <tr> <th data-bbox="732 456 889 488">w/ DCR</th> <th data-bbox="889 456 1039 488">w/o DCR</th> </tr> </thead> <tbody> <tr> <td rowspan="14" style="text-align: center;">200 V</td> <td>0.75</td> <td>FRN0.75F1S-2□</td> <td>5</td> <td>10</td> </tr> <tr> <td>1.5</td> <td>FRN1.5F1S-2□</td> <td rowspan="3">10</td> <td>15</td> </tr> <tr> <td>2.2</td> <td>FRN2.2F1S-2□</td> <td>20</td> </tr> <tr> <td>3.7</td> <td>FRN3.7F1S-2□</td> <td>30</td> </tr> <tr> <td>5.5</td> <td>FRN5.5F1S-2□</td> <td>30</td> <td>50</td> </tr> <tr> <td>7.5</td> <td>FRN7.5F1S-2□</td> <td>40</td> <td>75</td> </tr> <tr> <td>11</td> <td>FRN11F1S-2□</td> <td>50</td> <td>100</td> </tr> <tr> <td>15</td> <td>FRN15F1S-2□</td> <td>75</td> <td>125</td> </tr> <tr> <td>18.5</td> <td>FRN18.5F1S-2□</td> <td>100</td> <td>150</td> </tr> <tr> <td>22</td> <td>FRN22F1S-2□</td> <td>100</td> <td>175</td> </tr> <tr> <td>30</td> <td>FRN30F1S-2□</td> <td>150</td> <td>200</td> </tr> <tr> <td>37</td> <td>FRN37F1S-2□</td> <td>175</td> <td>250</td> </tr> <tr> <td>45</td> <td>FRN45F1S-2□</td> <td>200</td> <td>300</td> </tr> <tr> <td>55</td> <td>FRN55F1S-2□</td> <td>250</td> <td>350</td> </tr> <tr> <td>75</td> <td>FRN75F1S-2□</td> <td>350</td> <td>-</td> </tr> <tr> <td rowspan="19" style="text-align: center;">400 V</td> <td>0.75</td> <td>FRN0.75F1S-4□</td> <td rowspan="3">5</td> <td>5</td> </tr> <tr> <td>1.5</td> <td>FRN1.5F1S-4□</td> <td>10</td> </tr> <tr> <td>2.2</td> <td>FRN2.2F1S-4□</td> <td>15</td> </tr> <tr> <td>3.7</td> <td>FRN3.7F1S-4□</td> <td rowspan="2">10</td> <td rowspan="2">20</td> </tr> <tr> <td>(4.0)*</td> <td>FRN4.0F1S-4E</td> </tr> <tr> <td>5.5</td> <td>FRN5.5F1S-4□</td> <td>15</td> <td>30</td> </tr> <tr> <td>7.5</td> <td>FRN7.5F1S-4□</td> <td>20</td> <td>40</td> </tr> <tr> <td>11</td> <td>FRN11F1S-4□</td> <td>30</td> <td>50</td> </tr> <tr> <td>15</td> <td>FRN15F1S-4□</td> <td>40</td> <td>60</td> </tr> <tr> <td>18.5</td> <td>FRN18.5F1S-4□</td> <td>40</td> <td>75</td> </tr> <tr> <td>22</td> <td>FRN22F1S-4□</td> <td>50</td> <td>100</td> </tr> <tr> <td>30</td> <td>FRN30F1S-4□</td> <td>75</td> <td>125</td> </tr> <tr> <td>37</td> <td>FRN37F1S-4□</td> <td>100</td> <td>125</td> </tr> <tr> <td>45</td> <td>FRN45F1S-4□</td> <td>100</td> <td>150</td> </tr> <tr> <td>55</td> <td>FRN55F1S-4□</td> <td>125</td> <td>200</td> </tr> <tr> <td>75</td> <td>FRN75F1S-4□</td> <td>175</td> <td>-</td> </tr> <tr> <td>90</td> <td>FRN90F1S-4□</td> <td>200</td> <td>-</td> </tr> <tr> <td>110</td> <td>FRN110F1S-4□</td> <td>250</td> <td>-</td> </tr> <tr> <td>132</td> <td>FRN132F1S-4□</td> <td>300</td> <td>-</td> </tr> <tr> <td>160</td> <td>FRN160F1S-4□</td> <td>350</td> <td>-</td> </tr> <tr> <td>200</td> <td>FRN200F1S-4□</td> <td rowspan="2">500</td> <td>-</td> </tr> <tr> <td>220</td> <td>FRN220F1S-4□</td> <td>-</td> </tr> </tbody> </table>	Input power source (3-phase)	Applicable motor rating (kW)	Inverter type	Rated current of MCCB and ELCB (A)		w/ DCR	w/o DCR	200 V	0.75	FRN0.75F1S-2□	5	10	1.5	FRN1.5F1S-2□	10	15	2.2	FRN2.2F1S-2□	20	3.7	FRN3.7F1S-2□	30	5.5	FRN5.5F1S-2□	30	50	7.5	FRN7.5F1S-2□	40	75	11	FRN11F1S-2□	50	100	15	FRN15F1S-2□	75	125	18.5	FRN18.5F1S-2□	100	150	22	FRN22F1S-2□	100	175	30	FRN30F1S-2□	150	200	37	FRN37F1S-2□	175	250	45	FRN45F1S-2□	200	300	55	FRN55F1S-2□	250	350	75	FRN75F1S-2□	350	-	400 V	0.75	FRN0.75F1S-4□	5	5	1.5	FRN1.5F1S-4□	10	2.2	FRN2.2F1S-4□	15	3.7	FRN3.7F1S-4□	10	20	(4.0)*	FRN4.0F1S-4E	5.5	FRN5.5F1S-4□	15	30	7.5	FRN7.5F1S-4□	20	40	11	FRN11F1S-4□	30	50	15	FRN15F1S-4□	40	60	18.5	FRN18.5F1S-4□	40	75	22	FRN22F1S-4□	50	100	30	FRN30F1S-4□	75	125	37	FRN37F1S-4□	100	125	45	FRN45F1S-4□	100	150	55	FRN55F1S-4□	125	200	75	FRN75F1S-4□	175	-	90	FRN90F1S-4□	200	-	110	FRN110F1S-4□	250	-	132	FRN132F1S-4□	300	-	160	FRN160F1S-4□	350	-	200	FRN200F1S-4□	500	-	220	FRN220F1S-4□	-
	Input power source (3-phase)	Applicable motor rating (kW)				Inverter type	Rated current of MCCB and ELCB (A)																																																																																																																																																	
			w/ DCR	w/o DCR																																																																																																																																																				
	200 V	0.75	FRN0.75F1S-2□	5	10																																																																																																																																																			
		1.5	FRN1.5F1S-2□	10	15																																																																																																																																																			
		2.2	FRN2.2F1S-2□		20																																																																																																																																																			
		3.7	FRN3.7F1S-2□		30																																																																																																																																																			
		5.5	FRN5.5F1S-2□	30	50																																																																																																																																																			
		7.5	FRN7.5F1S-2□	40	75																																																																																																																																																			
		11	FRN11F1S-2□	50	100																																																																																																																																																			
		15	FRN15F1S-2□	75	125																																																																																																																																																			
		18.5	FRN18.5F1S-2□	100	150																																																																																																																																																			
		22	FRN22F1S-2□	100	175																																																																																																																																																			
		30	FRN30F1S-2□	150	200																																																																																																																																																			
		37	FRN37F1S-2□	175	250																																																																																																																																																			
		45	FRN45F1S-2□	200	300																																																																																																																																																			
		55	FRN55F1S-2□	250	350																																																																																																																																																			
	75	FRN75F1S-2□	350	-																																																																																																																																																				
	400 V	0.75	FRN0.75F1S-4□	5	5																																																																																																																																																			
		1.5	FRN1.5F1S-4□		10																																																																																																																																																			
		2.2	FRN2.2F1S-4□		15																																																																																																																																																			
		3.7	FRN3.7F1S-4□	10	20																																																																																																																																																			
		(4.0)*	FRN4.0F1S-4E																																																																																																																																																					
		5.5	FRN5.5F1S-4□	15	30																																																																																																																																																			
		7.5	FRN7.5F1S-4□	20	40																																																																																																																																																			
		11	FRN11F1S-4□	30	50																																																																																																																																																			
		15	FRN15F1S-4□	40	60																																																																																																																																																			
		18.5	FRN18.5F1S-4□	40	75																																																																																																																																																			
		22	FRN22F1S-4□	50	100																																																																																																																																																			
		30	FRN30F1S-4□	75	125																																																																																																																																																			
		37	FRN37F1S-4□	100	125																																																																																																																																																			
45		FRN45F1S-4□	100	150																																																																																																																																																				
55		FRN55F1S-4□	125	200																																																																																																																																																				
75		FRN75F1S-4□	175	-																																																																																																																																																				
90		FRN90F1S-4□	200	-																																																																																																																																																				
110		FRN110F1S-4□	250	-																																																																																																																																																				
132		FRN132F1S-4□	300	-																																																																																																																																																				
160	FRN160F1S-4□	350	-																																																																																																																																																					
200	FRN200F1S-4□	500	-																																																																																																																																																					
220	FRN220F1S-4□		-																																																																																																																																																					
<p>* The applicable motor rating of FRN4.0F1S-4E to be shipped for EU is 4.0 kW.</p> <p>Note: A box (□) in the above table replaces A, K, or E depending on the shipping destination.</p> <p>Select the MCCB or RCD/ELCB with appropriate breaking capacity according to the power supply capacity.</p>																																																																																																																																																								

	Name of peripheral equipment	Function and application
Main peripheral equipment	Molded case circuit breaker Earth leakage circuit breaker* * with overcurrent protection	<div style="border: 1px solid black; padding: 10px; text-align: center;">  <h2 style="margin: 0;">WARNING</h2> </div> <p>When connecting the inverter to the power supply, add a recommended molded case circuit breaker and earth leakage circuit breaker* in the path of power supply. Do not use the devices with the rated current out of the recommended range.</p> <p>*With overcurrent protection</p> <p>Fire could occur.</p>
	Magnetic contactor (MC)	<p>An MC can be used at both the power input (primary) and output (secondary) sides of the inverter. At each side, the MC works as described below. When inserted in the output circuit of the inverter, an MC can also switch the motor drive power source between the inverter output and commercial power lines.</p> <p>■ At the power source (primary) side</p> <p>Insert an MC in the power source side of the inverter in order to:</p> <ol style="list-style-type: none"> 1) Forcibly cut off the inverter from the power source (generally, commercial/factory power lines) with the protection function built into the inverter, or with the terminal signal line. 2) Stop the inverter operation in an emergency when the inverter cannot interpret the stop command due to internal/external circuit failures. 3) Cut off the inverter from the power source when the MCCB inserted in the power source side cannot cut it off for maintenance or inspection purpose. If you are to use the MC for this purpose only, it is recommended that you use an MC capable of turning the MC ON/OFF manually. <p>Note: When your system requires the motor(s) driven by the inverter to be started/stopped with the MC, the frequency of the starting/stopping operation should be once or less per hour. The more frequent the operation, the shorter operation life of the MC and capacitor/s used in the DC link bus due to thermal fatigue caused by the frequent charging of the current flow. If this is not necessary, start/stop the motor with the terminal commands (FWD), (REV) and/or (HLD), or with the keypad.</p> <p>■ At the output (secondary) side</p> <p>Prevent externally turned-around current from being applied to the inverter power output terminals (U, V, and W) unexpectedly. An MC should be used, for example, if a circuit that switches the motor driving source between the inverter output and commercial/factory power lines is connected to the inverter.</p> <p>Note: As application of high voltage external current to the inverter's output side may break the IGBTs, MCs should be used in the power control system circuits to switch the motor drive power source to the commercial/factory power lines after the motor has come to a complete stop. Also ensure that voltage is never mistakenly applied to the inverter output terminals due to unexpected timer operation, or similar.</p> <p>■ Driving the motor using commercial power lines</p> <p>MCs can also be used to switch the power source of the motor driven by the inverter to a commercial power source.</p>

	Name of option	Function and application
Main option	DC reactors (DCRs)	<p>A DCR is mainly used for power supply normalization and for supplied power-factor reformation (for reducing harmonic components).</p> <p>1) For power supply normalization</p> <ul style="list-style-type: none"> - Use a DCR when the capacity of a power supply transformer exceeds 500 kVA and is 10 times or more than the rated inverter capacity. In this case, the percentage-reactance of the power source decreases, and harmonic components and their peak levels increase. These factors may break rectifiers or capacitors in the converter section of inverter, or decrease the capacitance of the capacitor (which can shorten the inverter's service life). - Also use a DCR when there are thyristor-driven loads or when phase-advancing capacitors are being turned ON/OFF. <p>2) For supplied power-factor reformation (harmonic component reduction)</p> <p>Generally a capacitor is used to reform the power factor of the load, however, it cannot be used in a system that includes an inverter. Using a DCR increases the reactance of inverter's power source so as to decrease harmonic components on the power source lines and reform the power factor of inverter. Using a DCR reforms the input power factor to approximately 86 to 90%.</p> <p>Note: At the time of shipping, a short bar is connected across the terminals P1 and P (+) on the terminal block. Remove the short bar when connecting a DCR.</p>
	Output circuit filters (OFLs)	<p>Include an OFL in the inverter power output (secondary) circuit to:</p> <p>1) Suppress the voltage fluctuation at the motor input terminals</p> <p>This protects the motor from insulation damage caused by the application of high voltage surge currents by the 400 V class of inverters.</p> <p>2) Suppress leakage current from the power output lines (due to harmonic components)</p> <p>This reduces the leakage current when the motor is hooked by long power feed lines. It is recommended that the length of the power feed line be kept to less than 400 m.</p> <p>3) Minimize emission and/or induction noise issued from the power output lines</p> <p>OFLs are effective in reducing noise from long power feed lines, such as those used in plants, etc.</p> <p>Note: Use an OFL within the allowable carrier frequency range specified by function code F26 (Motor sound (Carrier frequency)). Otherwise, the filter will overheat.</p>
	Ferrite ring reactors for reducing radio frequency noise (ACL)	<p>An ACL is used to reduce radio noise emitted by the inverter.</p> <p>An ACL suppresses the outflow of high frequency harmonics caused by switching operation for the power supply (primary) lines inside the inverter. Pass the power supply lines together through the ACL for 4 turns (coiled 3 times).</p> <p>If wiring length between the inverter and motor is less than 20 m, insert an ACL to the power supply (primary) lines; if it is more than 20 m, insert it to the power output (secondary) lines of the inverter.</p>
	EMC-compliant filter	<p>A special filter for making the inverter in conformity with Europe's EMC directives.</p>
	AC Reactor (ACR)	<ul style="list-style-type: none"> • This optional feature must be connected to the primary side (commercial power supply side) of the inverter, when the inter-phase unbalance factor of the commercial power supply is 2% to 3%. $\text{Voltage unbalance (\%)} = \frac{\text{Max. voltage (V)} - \text{Min. voltage (V)}}{3\text{-phase average voltage (V)}} \times 67$ <p>In case the inter-phase unbalance factor of the commercial power supply exceeds 3%, you would need to take other measures such as increasing the capacity of the inverter. Contact your Fuji Electric representative.</p> <ul style="list-style-type: none"> • In a DC link bus system (using terminals [P (+)] and [N (-)]), the AC reactor protects the inverter against damage caused by unbalance in current.

	Name of option	Function and application
Options for Operation and Communications	External potentiometer for frequency commands	An external potentiometer may be used to set the drive frequency. Connect the potentiometer to control signal terminals 11 to 13 of the inverter.
	Multi-function keypad	Allows you to monitor the status of the inverter including voltage, current, and input power, as well as to set various parameters in a conversational mode. Equipped with a liquid crystal display (LCD). Also allows you to copy function code data from one FRENIC-Eco inverter to another.
	Extension cable for remote keypad operation	The extension cable connects the RS485 communications port (standard) with a keypad or an RS485-USB converter. Three lengths are available: 5 m, 3 m and 1 m
	RS485 Communications Card	This makes communication to a PLC or personal computer system easy. (Option)
	RS485-USB converter	A converter that allows connection of an RS485 communications port to a USB port on a PC.
	Inverter support loader software	Inverter support loader software, Windows GUI (Graphics User Interface) based, that makes setting of function codes easy.
Other peripheral equipment	Surge absorbers	A surge absorber suppresses surge currents and noise from the power lines to ensure effective protection of your power system from the malfunctioning of the magnetic contactors, mini-relays and timers.
	Surge killers	A surge killer eliminates surge currents induced by lightening and noise from the power supply lines. Use of a surge killer is effective in preventing the electronic equipment, including inverters, from damage or malfunctioning caused by such surges and/or noise.
	Arresters	An arrester suppresses surge currents and noise invaded from the power supply lines. Use of an arrester is effective in preventing electronic equipment, including inverters, from damage or malfunctioning caused by such surges and/or noise.
	Frequency meter	Displays the frequency in accordance with signal output from the inverter.
Other options	Mounting adapters	FRENIC-Eco series of inverters can be installed to your system enclosure or equipment using mounting adapters which utilize the mounting holes used for conventional inverters of FRENIC5000P11S (5.5 kW, 15 kW or 30 kW) series. FRENIC5000P11S 7.5 kW, 11 kW, 18.5 kW and 22 kW models do not need this adapter.
	Attachment for external cooling	This adapter allows you to mount your FRENIC-Eco series of inverters on the panel in such a way that the heat sink assembly may be exposed to the outside. Using this adapter greatly reduces heat radiated or spread inside your enclosure. Applicable only to inverters with a capacity of 30 kW or below. (On inverters with a capacity of 37 kW or above, you only need to re-position the mounting bases.)

Chapter 10 CONFORMITY WITH STANDARDS

10.1 Conformity with UL Standards and Canadian Standards (cUL-listed for Canada)

10.1.1 General

The UL standards, originally established by Underwriters Laboratories, Inc. of U.S., are now a set of standards authorized in the U.S. for preventing fire and accidents, thereby protecting operators, service personnel, and ordinary citizens.

“cUL-listed for Canada” means that the products have been evaluated to the CSA Standards by the UL. Therefore, cUL-listed products are equivalent to those in conformity with CSA Standards.

10.1.2 Considerations when using FRENIC-Eco as a product certified by UL or cUL

If you want to use the FRENIC-Eco series of inverters as a part of UL Standards or CSA Standards (cUL-listed for Canada) certified product, refer to the related guidelines described on pages viii and ix.

10.2 Conformity with EU Directives

The CE Marking on Fuji products indicates that they comply with the essential requirements of the Electromagnetic Compatibility (EMC) Directive 2004/108/EC issued by the Council of the European Communities and the Low Voltage Directive 2006/95/EC.

EMC-filter built-in inverters that bear a CE Marking are in conformity with EMC Directives. Inverters having no EMC filter can be in conformity with EMC Directives if an optional EMC-compliant filter is mounted to them.

Inverters that bear a CE Marking are compliant with the Low Voltage Directive.

■ The FRENIC-Eco series of inverters is in conformity with the following standards:

Low Voltage Directive EN50178: 1997

EMC Directive EN61800-3: 2004

CAUTION

The FRENIC-Eco series of inverters is categorized as a "restricted sales distribution class" according to the EN61800-3. When you use these products in a domestic environment, you may need to take appropriate countermeasures to reduce or eliminate any noise emitted from these products.

10.3 Conformity with Low Voltage Directive

10.3.1 General

General-purpose inverters are subject to the regulations set forth by the Low Voltage Directive in the EU. Fuji Electric declares the inverters bearing a CE marking are compliant with the Low Voltage Directive.

10.3.2 Considerations when using FRENIC-Eco as a product in conformity with Low Voltage Directive

If you wish to use the FRENIC-Eco series of inverters as a product in conformity with the Low Voltage Directive, refer to the related guidelines described on pages vi and vii.

10.4 Harmonic Component Regulation in the EU

10.4.1 General

When a general-purpose industrial inverter is to be used in the EU, the harmonics emitted from the inverter to power lines are strictly regulated as stated below.

When an inverter whose rated input is 1 kW or below is connected to a public low-voltage power supply, it is subject to the harmonics emission regulations (users A and B below), except when the inverter is connected to an industrial low-voltage power supply (user C below). See Figure 10.1 for details.

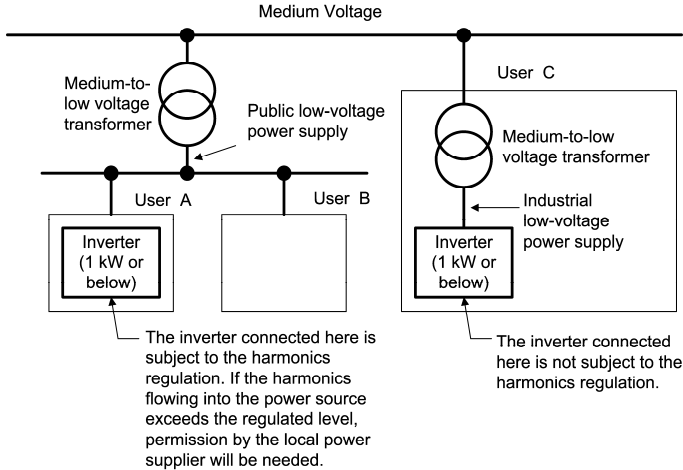

Figure 10.1 Connection to Power Line

10.4.2 Conformity with the harmonics regulation

A general-purpose industrial inverter is not a product in conformity with EN61000-3-2 (+A14). When you connect it to a low-voltage commercial power supply, you must obtain permission of the local power supplier (See the case of User A or B in Figure 10.1 above.) If you need harmonic current data of the inverter, consult your Fuji Electric representative.

10.5 Conformity with the EMC Directive in the EU

10.5.1 General

The CE Marking on inverters does not ensure that the entire equipment including CE-marked products is compliant with the EMC Directive. Therefore, it is the responsibility of the equipment manufacturer to ensure that the equipment including the product (inverter) or connected with it actually complies with the standard and to put a CE Marking as the equipment.

In general, the user's equipment comprises a variety of products supplied from a number of manufacturers in addition to Fuji inverters. Therefore, the manufacturer of the final equipment needs to take responsibility for conformity.

In addition, to satisfy the requirements noted above, it is necessary to use a Fuji inverter in connection with an EMC-compliant filter (option) and install it in accordance with the instructions contained in this instruction manual. Install the Fuji inverter in a metal enclosure.



To use Fuji EMC-filter built-in inverters, refer to the FRENIC-Eco Instruction Manual Supplement for EMC-Filter Built-in Type, Chapter 10, "CONFORMITY WITH STANDARDS."

10.5.2 EMC-compliant filter (Option)

There are two installation styles of an optional EMC-compliant filter--Footmount and split styles. As listed on the next page, the footmount style applies to inverters with 3-phase 400 V, 0.75 to 22 kW, and the split style, to inverters with 3-phase 200 V and 3-phase 400 V 30 to 220 kW.

For how to install the EMC-compliant filter, see Section 10.5.3 "Recommended installation of EMC-compliant filter."



The use of an EMC-compliant filter increases leakage current as shown on the next page.

Table 10.1 EMC-compliant Filters and Leakage Current

Power supply voltage	Inverter type	EMC-compliant filter model	Leakage current (mA) *1 *2		Installation style
			Normal condition	Worst condition	
3-phase 200 V	FRN0.75F1S-2□	EFL-4.0E11-2	2.96	2.96	Split style See Figure 10.2 (B).
	FRN1.5F1S-2□				
	FRN2.2F1S-2□				
	FRN3.7F1S-2□				
	FRN5.5F1S-2□	EFL-7.5E11-2	10.6	10.6	
	FRN7.5F1S-2□				
	FRN11F1S-2□	EFL-15SP-2	20.0	23.0	
	FRN15F1S-2□				
	FRN18.5F1S-2□	EFL-22SP-2	20.0	23.0	
	FRN22F1S-2□				
	FRN30F1S-2□	FS5536-180-40	37.0	211.0	
	FRN37F1S-2□	FS5536-250-28	78.0	424.0	
	FRN45F1S-2□				
FRN55F1S-2□	FS5536-400-99	89.0	484.0		
FRN75F1S-2□					
3-phase 400 V	FRN0.75F1S-4□	EFL-4.0G11-4	3.0	105.0	Footmount style See Figure 10.2 (A).
	FRN1.5F1S-4□				
	FRN2.2F1S-4□				
	FRN3.7F1S-4□ FRN4.0F1S-4E *3				
	FRN5.5F1S-4□ *4	EFL-7.5G11-4	3.0	105.0	
	FRN7.5F1S-4□				
	FRN11F1S-4□				
	FRN15F1S-4□ *4	EFL-15G11-4	6.0	158.0	
	FRN18.5F1S-4□	EFL-22G11-4	3.0	105.0	
	FRN22F1S-4□				
	FRN30F1S-4□	FS5536-100-35	24.4	143.0	
	FRN37F1S-4□				
	FRN45F1S-4□				
	FRN55F1S-4□	FS5536-180-40	37.0	211.0	
	FRN75F1S-4□				
	FRN90F1S-4□				
	FRN110F1S-4□				
FRN132F1S-4□	FS5536-250-28	78.0	424.0		
FRN160F1S-4□					
FRN200F1S-4□	FS5536-400-99-1				
FRN220F1S-4□					

Note: A box (□) in the above table replaces A, K, or E depending on the shipping destination.

*1 The values are calculated assuming the power supply frequency of 50 Hz for both 3-phase 240V and 3-phase 400V.

*2 The worst condition includes a phase loss in the supply line.

*3 The applicable motor rating of FRN4.0F1S-4E to be shipped for EU is 4.0 kW.

*4 Requires a panel-mount adapter (option).

10.5.3 Recommended installation of EMC-compliant filter

This section shows how to install an EMC-compliant filter. In the footmount style, mount the inverter on the EMC-compliant filter. In the split style, mount the filter beside or under the inverter.

Note For the footmount style, inverters with ratings of 400 V 5.5 kW and 15 kW require a panel-mount adapter (option) as listed below.

Table 10.2 EMC-compliant Filter and Panel-mount Adapter (option)

3-phase 400 V	Inverter type	EMC filter model [Bundled screws to fix the filter onto panel-mount adapter]	Panel-mount adapter model [Bundled screws to fix the adapter onto inverter]
5.5 kW	FRN5.5F1S-4□	EFL-7.5G11-4 [Four M8 x 20 screws]	MA-F1-5.5 [Four M5 x 15 screws]
15 kW	FRN15F1S-4□	EFL-15G11-4 [Four M8 x 20 screws]	MA-F1-15 [Four M8 x 25 screws]

Note: A box (□) in the above table replaces A, K, or E depending on the shipping destination.

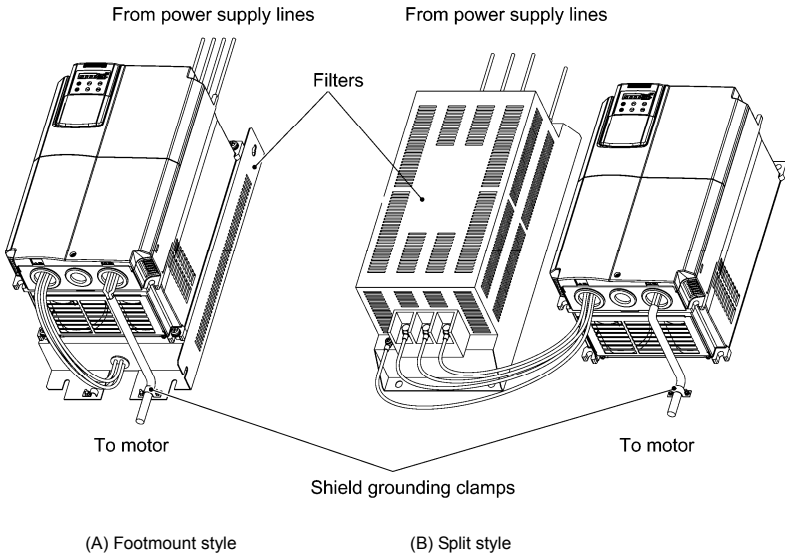

Figure 10.2 Installing Inverter and EMC-compliant Filter

The EMC-compliant filter and the inverter should be connected with each other according to the procedure given below. The wiring on the inverter and motor should be performed by an authorized electrical engineer. In order to ensure compliance with the EMC Directive, this procedure should be followed as closely as possible.

Basic connection procedure

- 1) Install the inverter and the EMC-compliant filter on a grounded metal plate. Use a shielded cable also for connection to the motor and make it as short as possible. Connect the shield layer of the cable firmly to the metal plate. Also, at the motor side, connect the shield layer electrically to the grounding terminal of the motor.
- 2) Use a shielded cable for connection of control circuit lines of the inverter and also for connection of the signal cable of an RS485 communications card. As with the motor, clamp the shield layer of the cable firmly to a grounded plate.
- 3) If noise radiated from the inverter exceeds the level prescribed in the EMC Directive, enclose the inverter and its peripherals (EMC-compliant filter) inside a metal enclosure as shown in Figure 10.3.

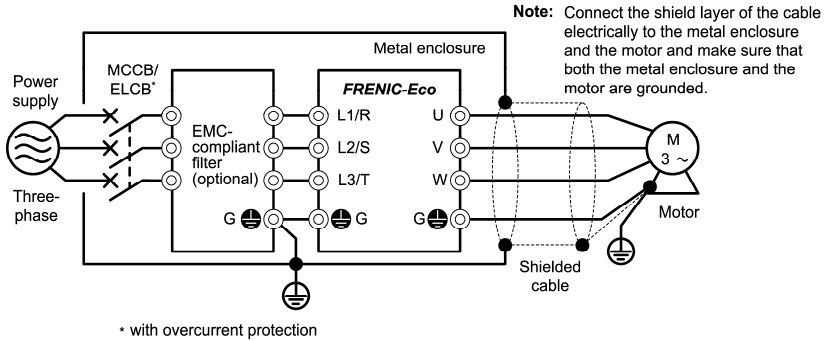

Figure 10.3 Installation of EMC-Compliant Filter (Option)

10.5.4 EMC-compliant environment and class

The table below lists the capacity and power supply voltage of the FRENIC-Eco and the EMC-compliant environment.

Power supply voltage	Standards	Inverter capacity	
		0.75 to 90 kW	110 to 220 kW
3-phase 200 V	Immunity	Second environment (Industrial environment)	
	Emission	Second environment (Industrial environment)	
3-phase 400 V	Immunity	Second environment (Industrial environment)	
	Emission	Category C2	Category C3 Note 1

Note 1: Wiring change for compliance

Changing the internal wiring makes EMC-compliant level (emission) be in conformity with Category C2. Refer to the wiring procedures given on the following pages.

⚠ WARNING ⚠

Before changing any internal wiring, turn OFF the power and wait more than five minutes for models of 30 kW or below, or ten minutes for models of 37 kW or above. Make sure that the LED monitor and charging lamp (on models of 37 kW or above) are turned OFF. Further, make sure, using a multimeter or a similar instrument, that the DC link bus voltage between the terminals P (+) and N (-) has dropped below the safe voltage (+25 VDC).

Otherwise electric shock could occur.

FRN110F1S-4□

- 1) Remove the front cover. (Refer to Chapter 2, Section 2.3 "Wiring.")
- 2) Change wiring at points A and B shown in the internal location diagram below.

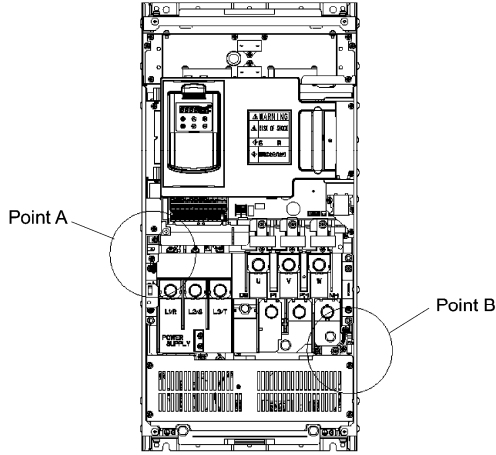

Figure 10.4 Internal Location Diagram (FRN110F1S-4□)

Point A As shown below, remove the screw (M4) to release the wire end terminal and secure the terminal to the support with the screw removed. (Tightening torque: 1.8 N·m)

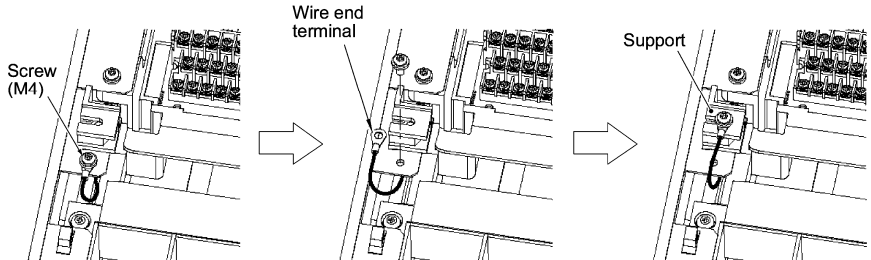

Figure 10.5 Point A

Point B As shown below, cut the cable tie (insulation lock) with a nipper to remove the protective cap. Remove the screw (M5) and secure the wire end terminal with the screw removed. (Tightening torque: 3.5 N·m)

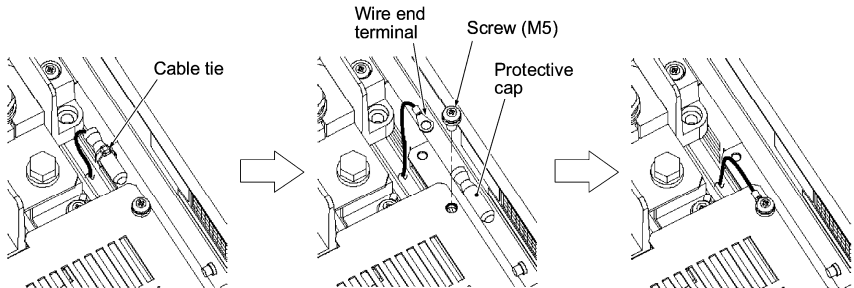

Figure 10.6 Point B

FRN200F1S-4□, FRN220F1S-4□

- 1) Remove the front cover. Refer to Chapter 2, Section 2.3 "Wiring."
- 2) Change wiring at points A and B shown in the internal location diagram below.

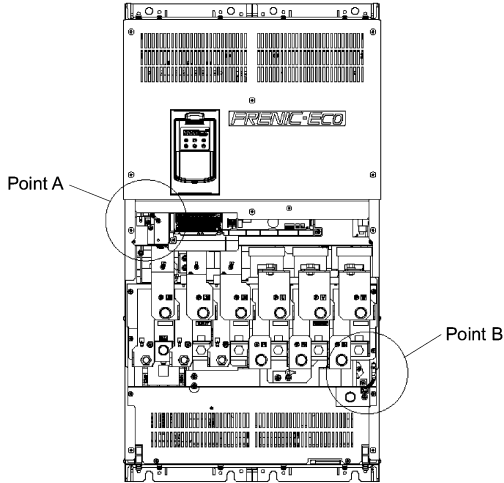

Figure 10.10 Internal Location Diagram (FRN200F1S-4□, FRN220F1S-4□)

Point A As shown below, remove the screw (M4) to release the wire end terminal and secure the terminal to the support with the screw removed. (Tightening torque: 1.8 N·m)

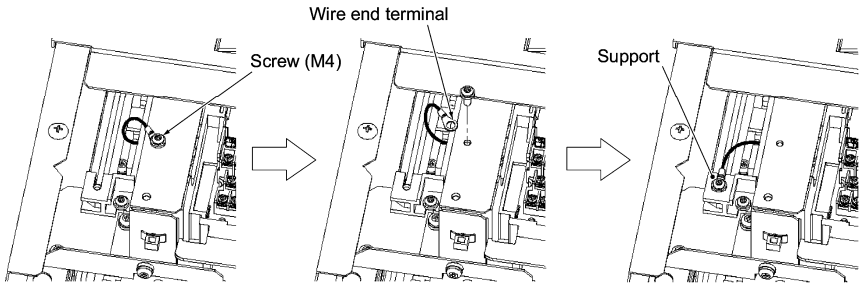

Figure 10.11 Point A

Point B As shown below, cut the cable tie (insulation lock) with a nipper to remove the protective cap. Remove the screw (M5) and secure the wire end terminal with the screw removed. (Tightening torque: 3.5 N·m)

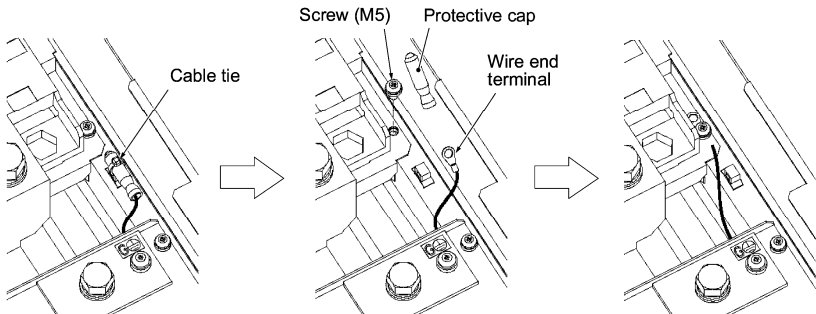

Figure 10.12 Point B



The wiring change in Note 1 can improve the EMC-compliant level of the inverter for an environment or class; however, it increases the leakage currents listed in Table 10.1 to the ones listed below. Make sure that these leakage currents are allowable for your system requirements beforehand.

Power supply voltage	Inverter type	EMC-compliant filter model	Leakage current (mA)	
			Normal condition	Worst condition
3-phase 400 V	FRN110F1S-4□	FS5536-250-28	108.0	464.0
	FRN132F1S-4□			
	FRN160F1S-4□	FS5536-400-99-1		
	FRN200F1S-4□			
	FRN220F1S-4□			

For improvement in EMC compliance for 3-phase 200 V types of inverters, consult your Fuji Electric representative for improving EMC-compliant level.

Designed For Fan and Pump Applications

FRENIC-ECO

Instruction Manual

First Edition, May 2005
Third Edition, September 2010
Fuji Electric Systems Co., Ltd.

The purpose of this instruction manual is to provide accurate information in handling, setting up and operating of the FRENIC-Eco series of inverters. Please feel free to send your comments regarding any errors or omissions you may have found, or any suggestions you may have for generally improving the manual.

In no event will Fuji Electric Systems Co., Ltd. be liable for any direct or indirect damages resulting from the application of the information in this manual.

Fuji Electric Systems Co., Ltd.

Starzen Shinagawa Bldg., 2-4-13, Konan, Minato-ku, Tokyo 108-0075, Japan

Phone: +81 3 6717 0617 Fax: +81 3 6717 0585

URL <http://www.fujielectric.com/fes/>
